



US00D399719S

United States Patent [19] Mignanelli

[11] Patent Number: **Des. 399,719**

[45] Date of Patent: ****Oct. 20, 1998**

[54] **COMBINED CORDLESS GLUE GUN AND BASE**

4,951,846 8/1990 Oster et al. 222/146.5

[76] Inventor: **Jane Mignanelli**, 207 McKinley Ave., Franklin Square, N.Y. 11010

Primary Examiner—Terry A. Wallace
Attorney, Agent, or Firm—Goldstein & Associates

[**] Term: **14 Years**

[57] **CLAIM**

The ornamental design for a combined cordless glue gun and base, as shown and described.

[21] Appl. No.: **81,302**

DESCRIPTION

[22] Filed: **Dec. 29, 1997**

[51] **LOC (6) Cl.** **08-05**

[52] **U.S. Cl.** **D8/68; D8/14.1; D8/30**

[58] **Field of Search** D8/14.1, 29.1, D8/30, 61, 68; 219/227, 229, 242, 259; 222/146.1, 146.5, 327, 391

FIG. 1 is an exploded perspective view of a combined cordless glue gun and base showing my new design; FIG. 2 is an exploded front elevation view thereof; FIG. 3 is an exploded rear elevation view thereof; FIG. 4 is a top plan view thereof; FIG. 5 is a bottom plan view thereof; FIG. 6 is an exploded right side elevation view thereof; and, FIG. 7 is an exploded left side elevation view thereof.

[56] **References Cited**

U.S. PATENT DOCUMENTS

D. 303,611 9/1989 Spirk, Jr. et al. D8/14.1

1 Claim, 5 Drawing Sheets

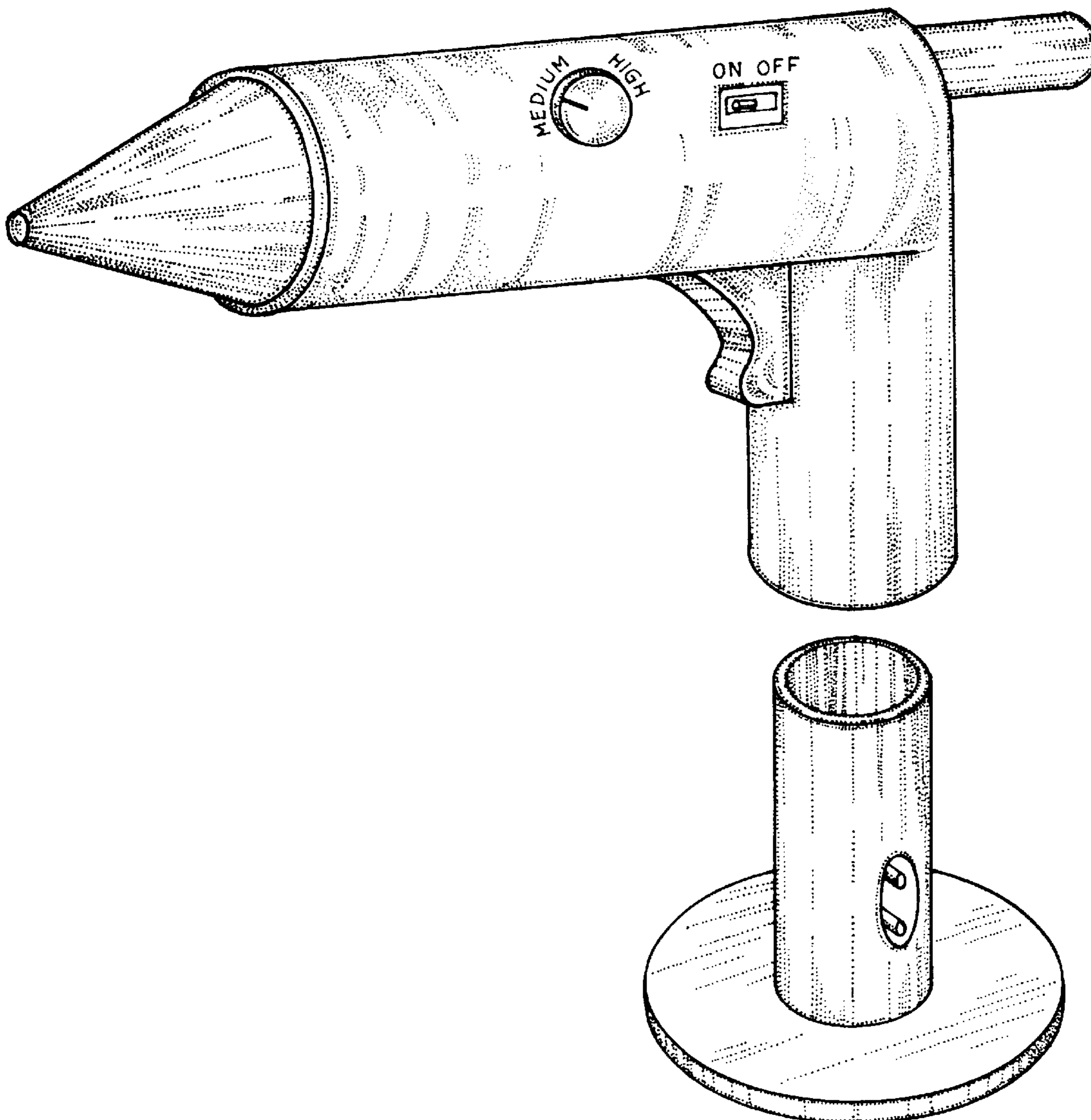

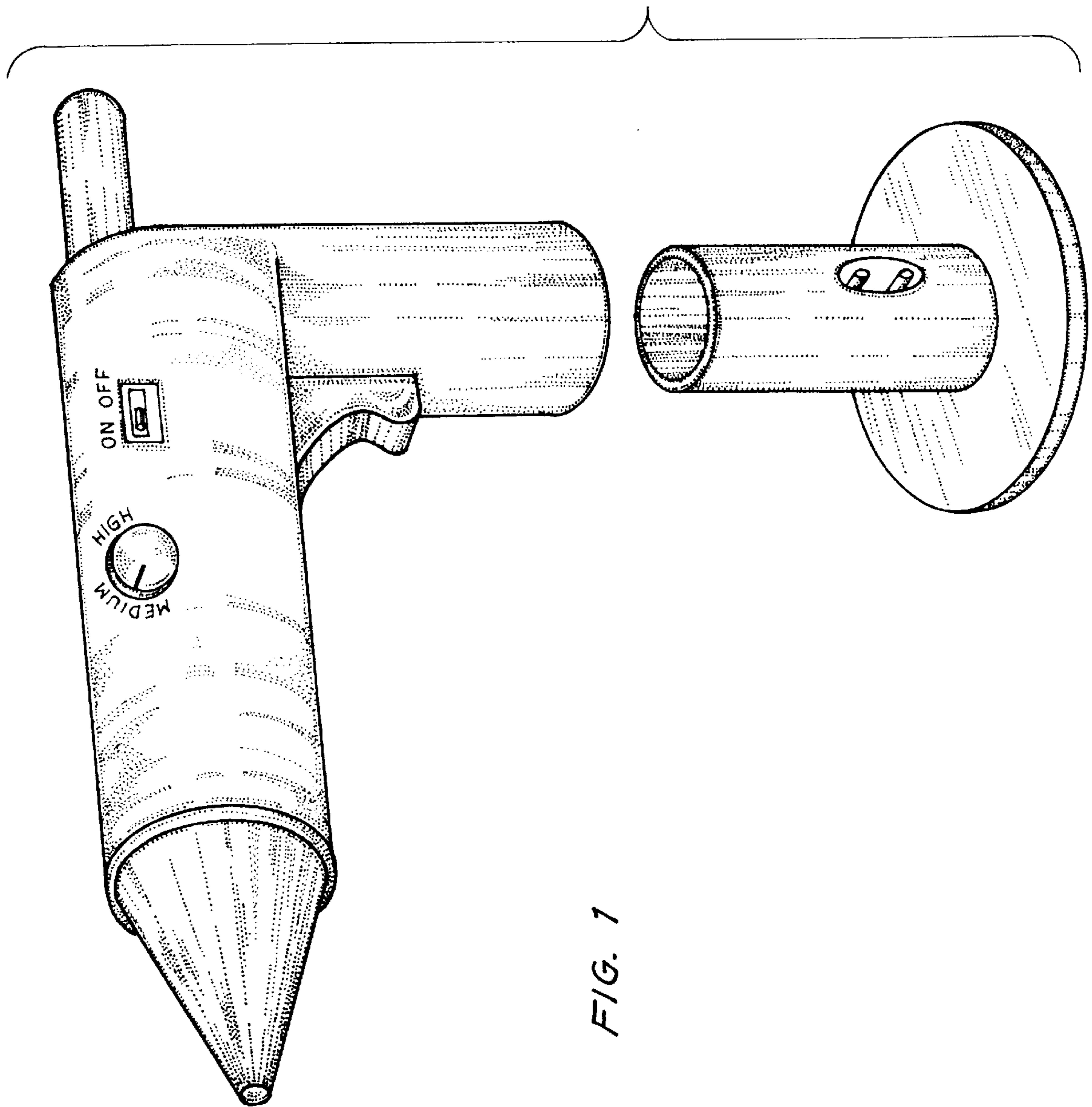

FIG. 1

FIG. 3

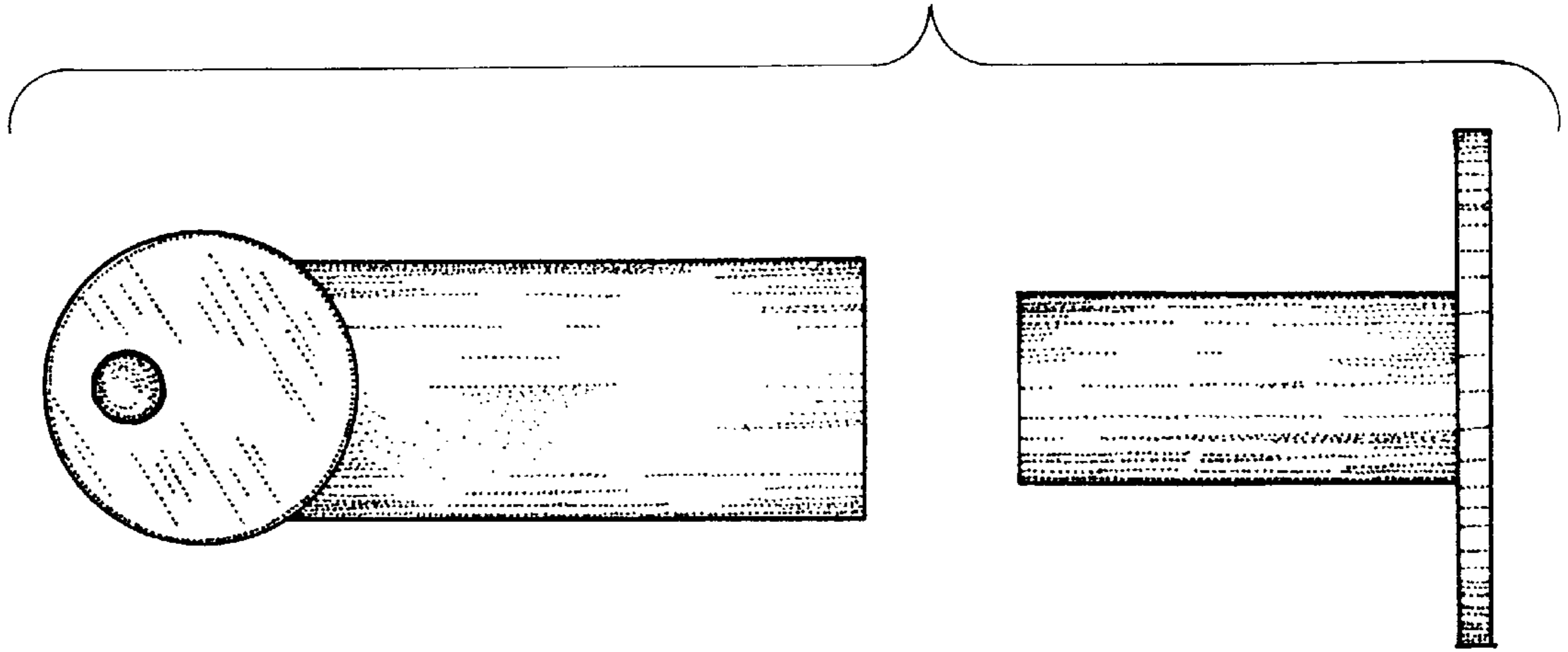

FIG. 2

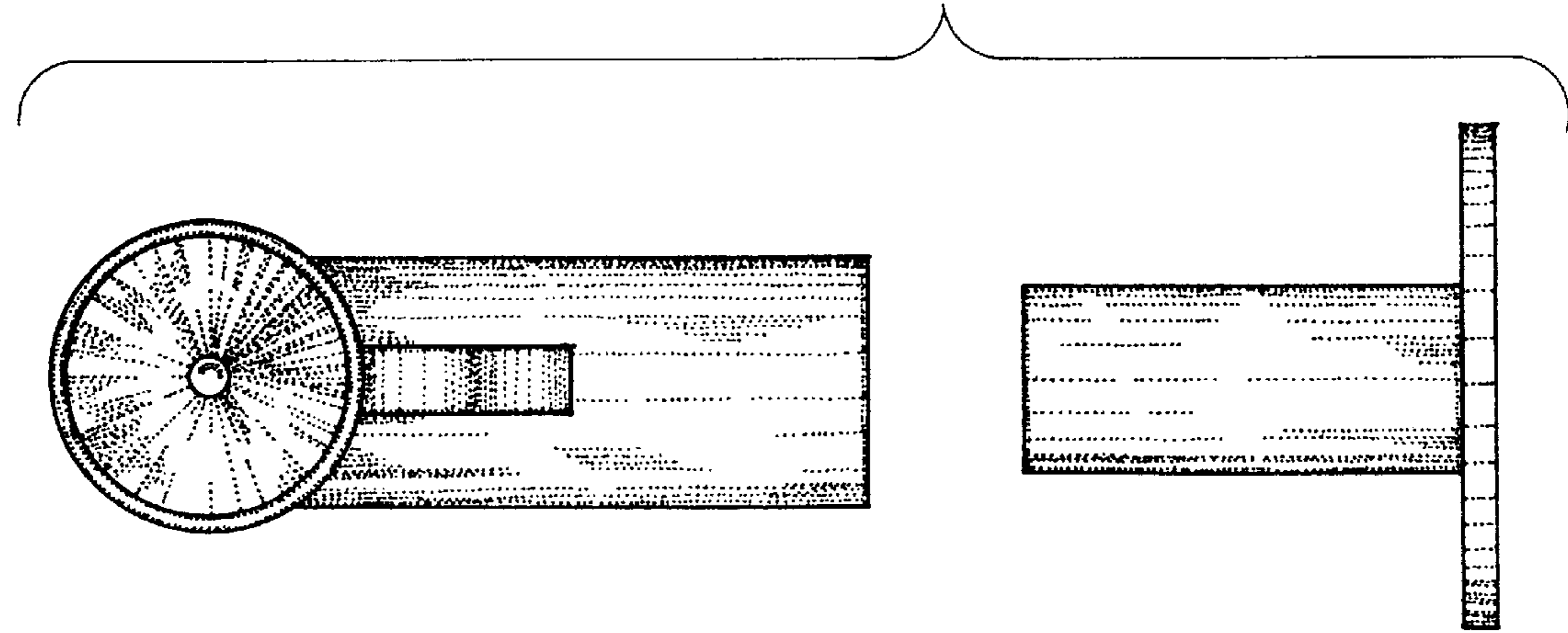

FIG. 5

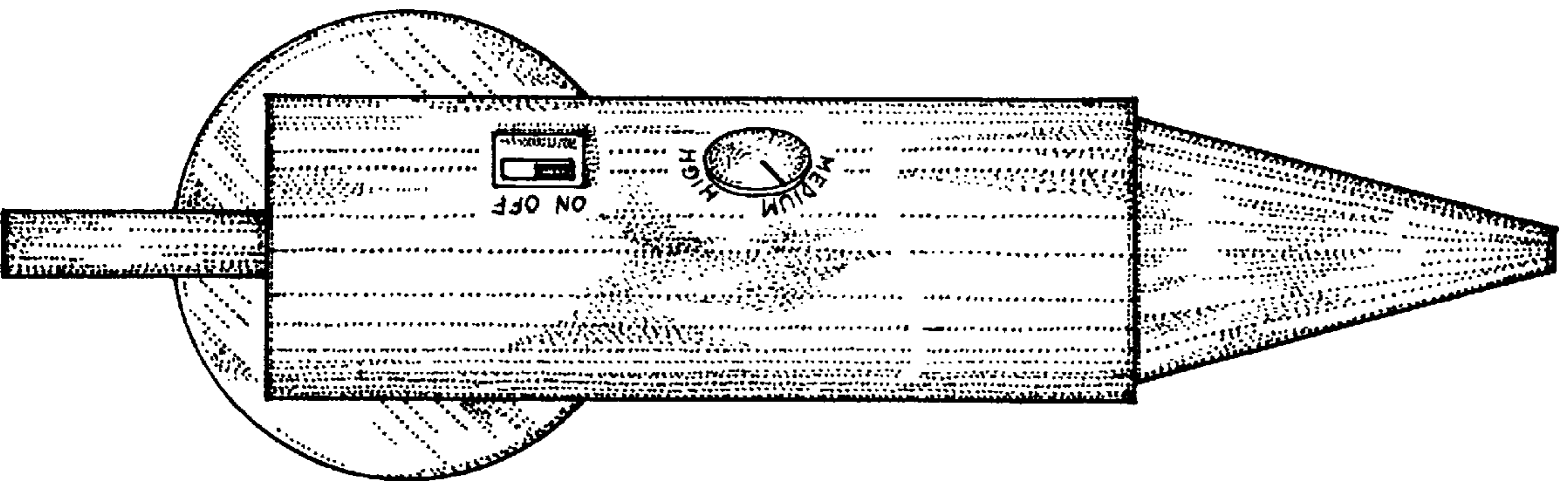
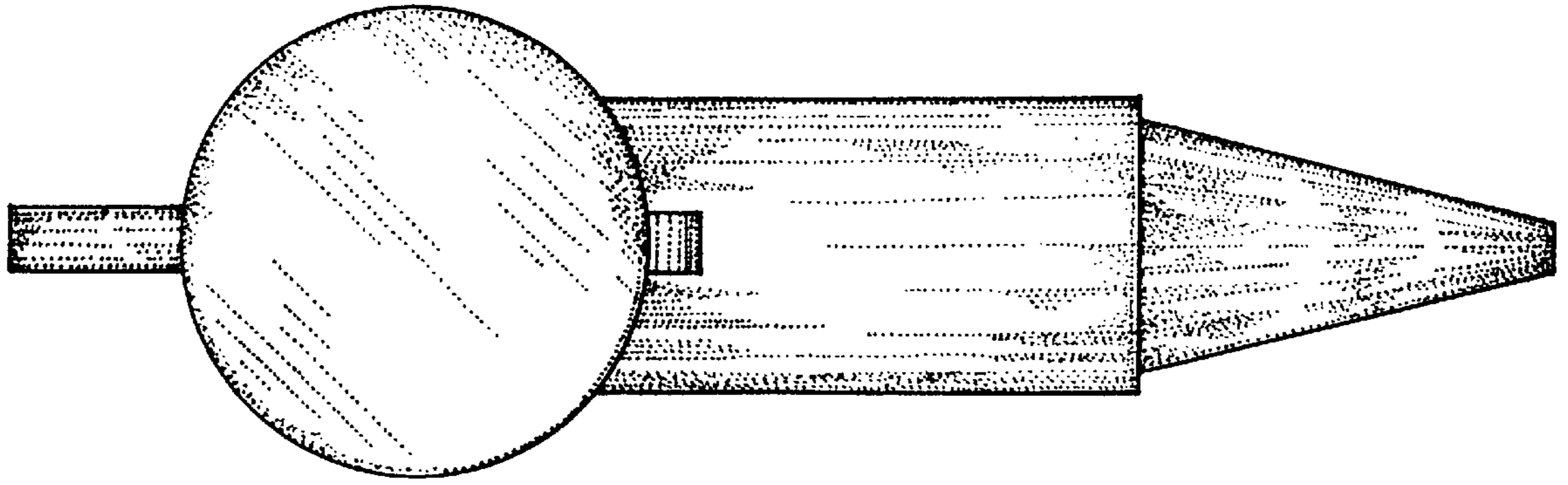

FIG. 4

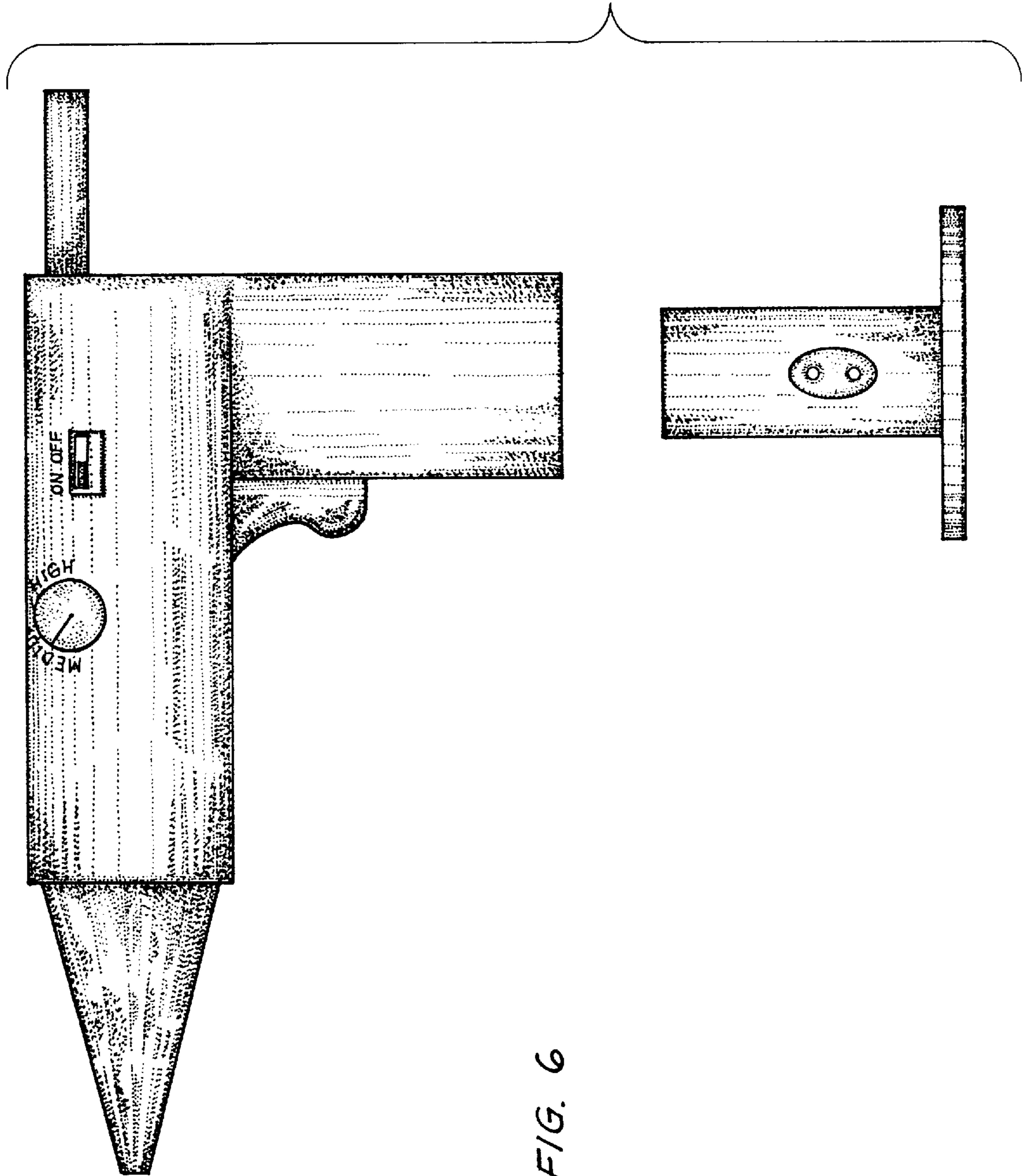

FIG. 6

