



US00D399679S

# United States Patent [19]

Canton Gongora et al.

[11] Patent Number: **Des. 399,679**

[45] Date of Patent: **\*\*Oct. 20, 1998**

[54] **DISPLAY STAND WITH BACK SCREEN**

[75] Inventors: **Antonio Canton Gongora; Carlos Jesus Cruz Fernandez; José María Muñagorri Enriquez; Juan Carlos Rayo Ortigüela**, all of Madrid, Spain

[73] Assignee: **Telefonica de España, s.a.**, Madrid, Spain

[\*\*] Term: **14 Years**

[21] Appl. No.: **62,758**

[22] Filed: **Nov. 22, 1996**

### [30] Foreign Application Priority Data

Mar. 22, 1996 [ES] Spain ..... 137552

[51] **LOC (6) Cl.** ..... **06-04**

[52] **U.S. Cl.** ..... **D6/478; D6/396**

[58] **Field of Search** ..... D6/449, 438, 440, D6/396, 397, 477-479, 426, 466-468, 462, 332, 464, 465; D25/58; 160/351, 352; 108/28, 59, 33, 60, 161; 211/134, 135, 153, 59.1, 180, 131; 52/220.7, 761; 312/237, 240, 294, 310, 351.1

### [56] References Cited

#### U.S. PATENT DOCUMENTS

D. 290,204 6/1987 Bruget ..... D6/479

D. 293,865 1/1988 Robertson ..... D6/478  
D. 367,372 2/1996 Eng et al. .... D6/396  
D. 369,248 4/1996 Lechleiter et al. .... D6/396  
4,020,604 5/1977 Legler et al. .... 160/351 X

*Primary Examiner*—James Gandy  
*Assistant Examiner*—Linda Brooks  
*Attorney, Agent, or Firm*—Reid & Priest LLP

### [57] CLAIM

The ornamental design for a display stand with back screen, as shown and described.

### DESCRIPTION

FIG. 1 is a front elevation view of a display stand with back screen embodying our new and ornamental design;  
FIG. 2 is a right side elevation view thereof;  
FIG. 3 is a top plan view thereof;  
FIG. 4 is a bottom plan view thereof;  
FIG. 5 is a left side elevation view thereof;  
FIG. 6 is a rear elevation view thereof;  
FIG. 7 is a front perspective view thereof; and,  
FIG. 8 is a rear perspective view thereof.

**1 Claim, 3 Drawing Sheets**

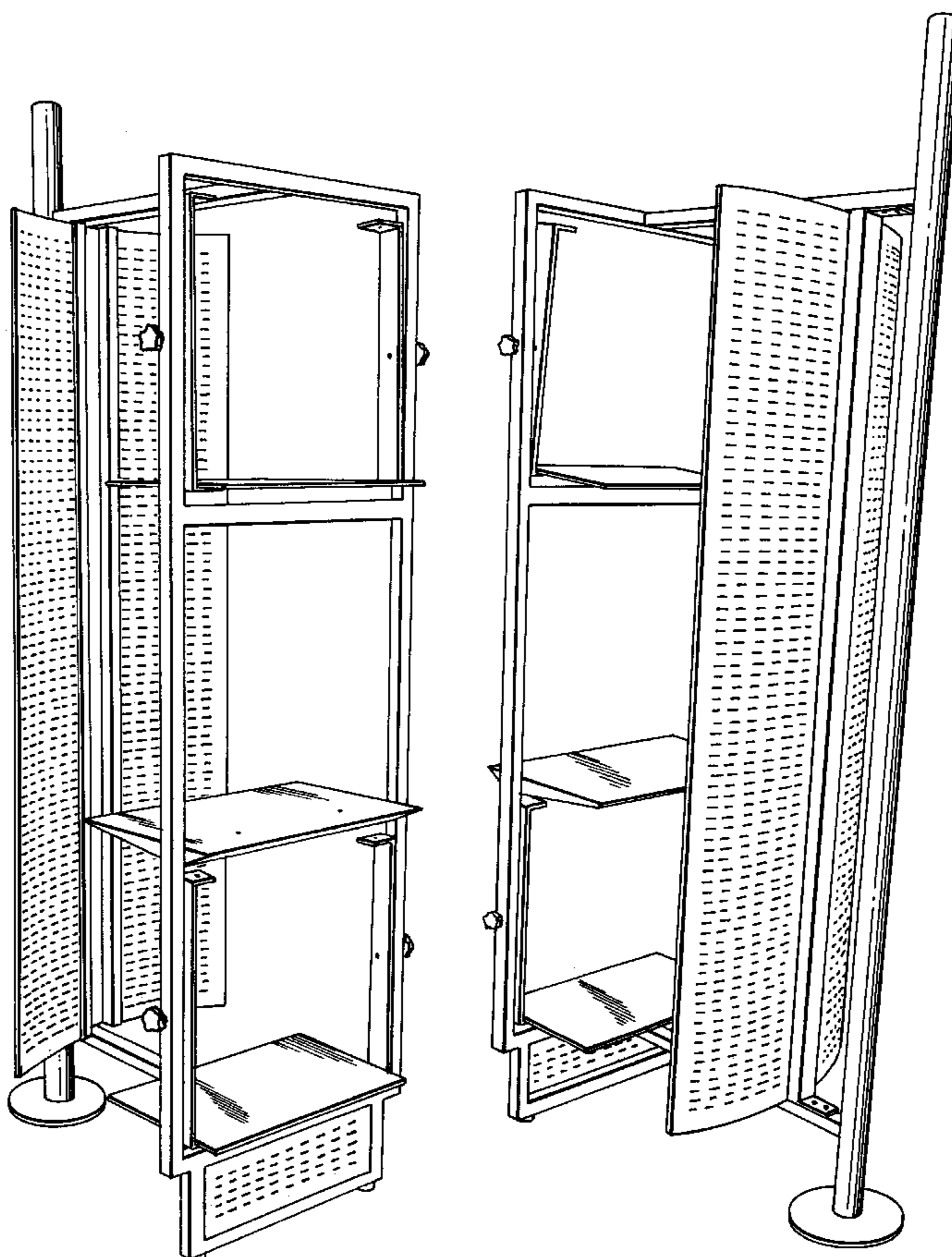

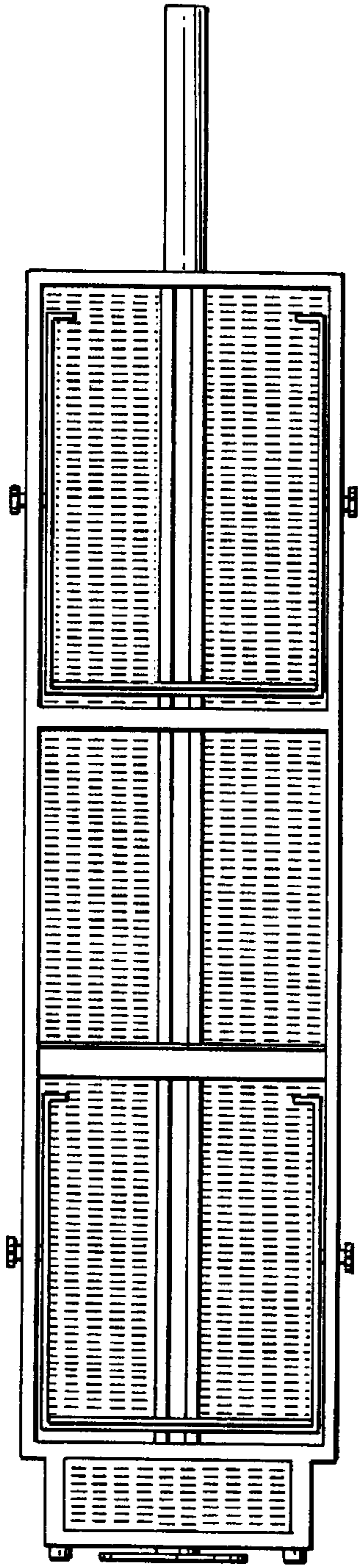

FIG. 1

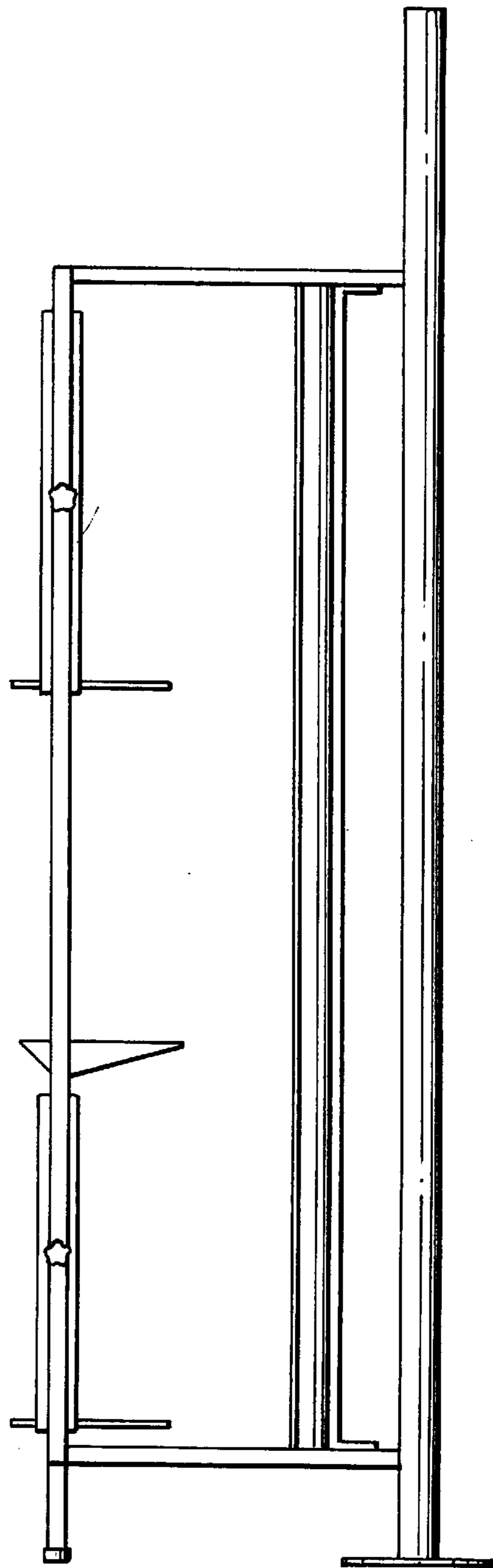
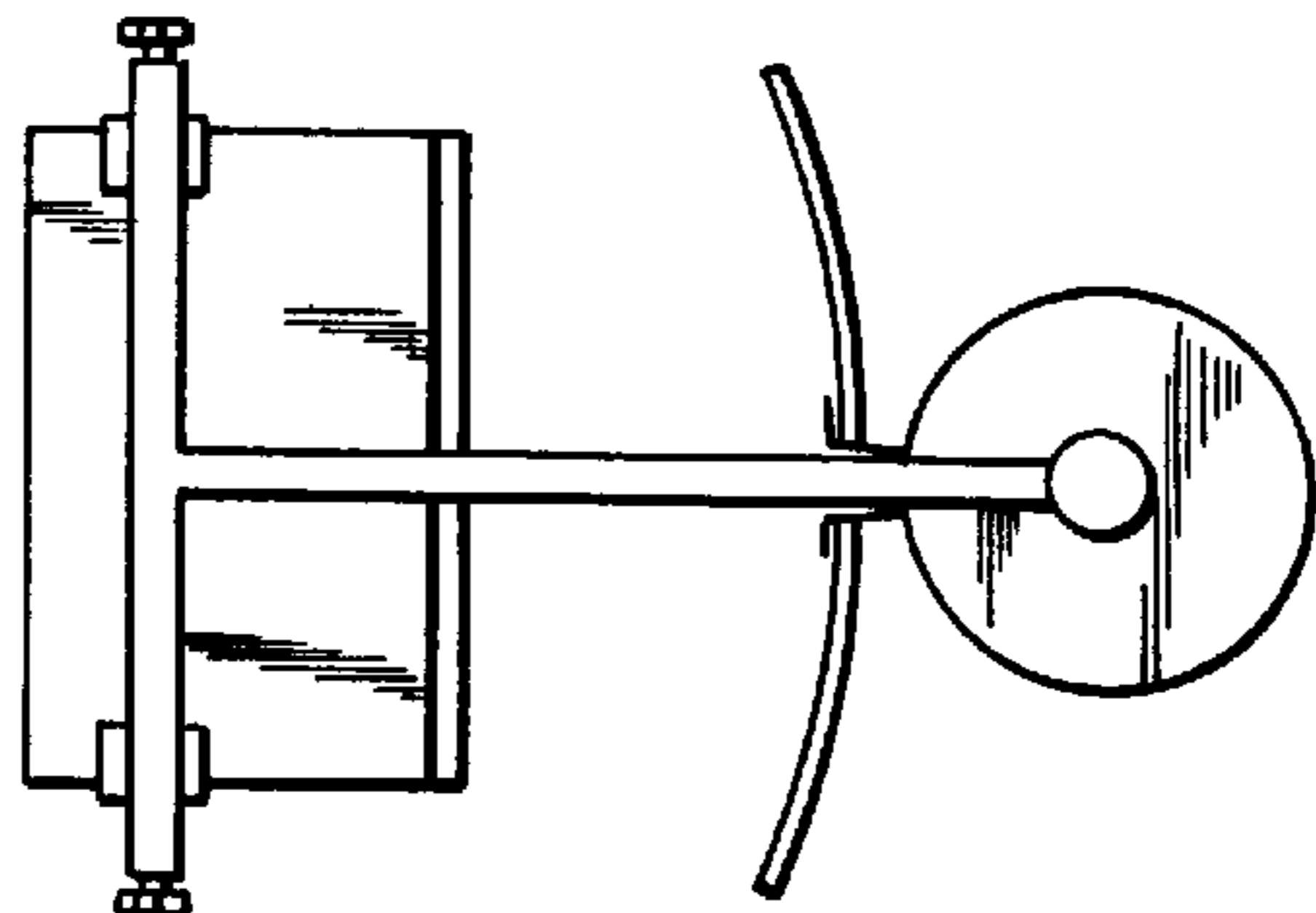

FIG. 2

FIG. 3



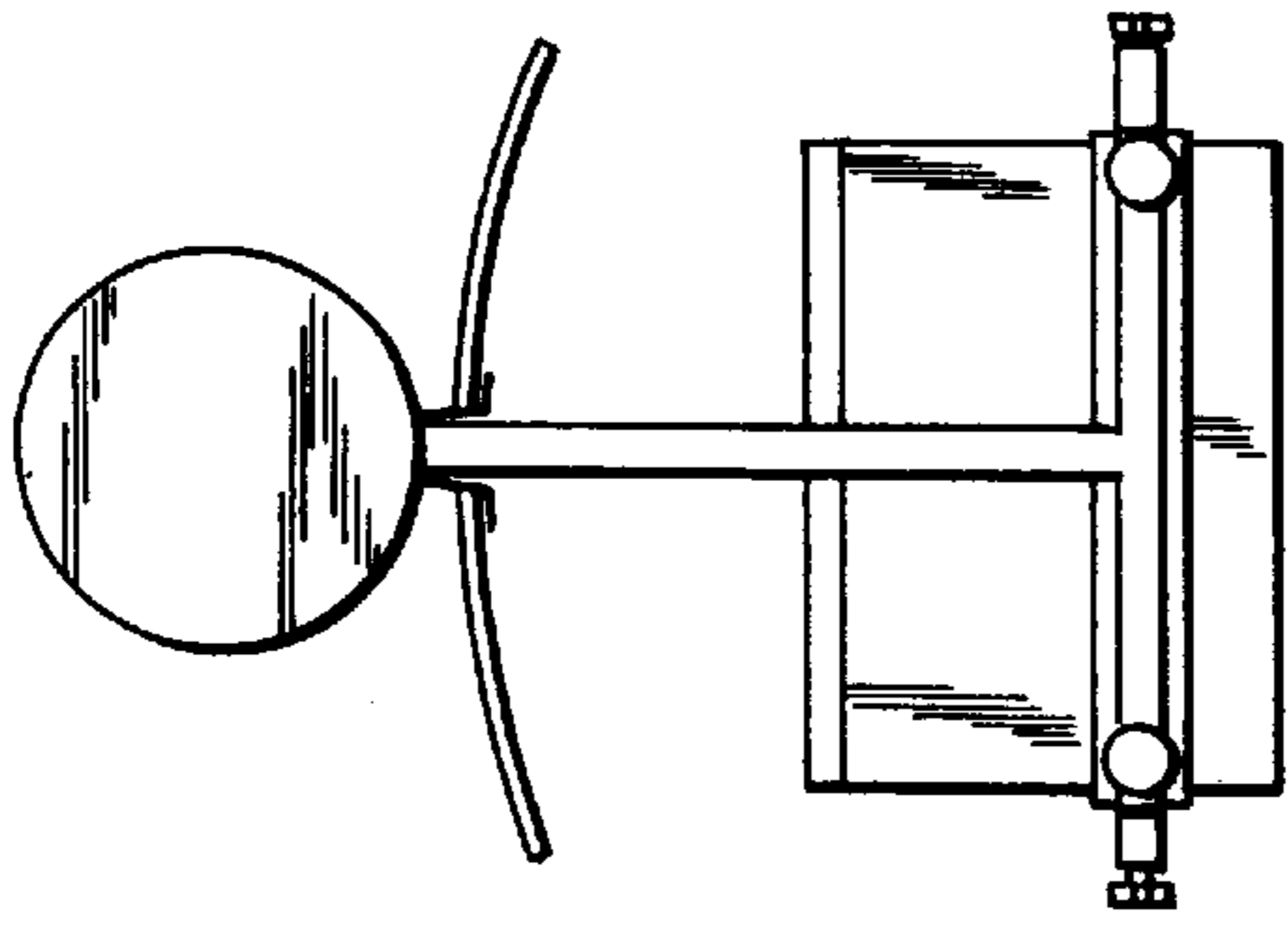

FIG. 4

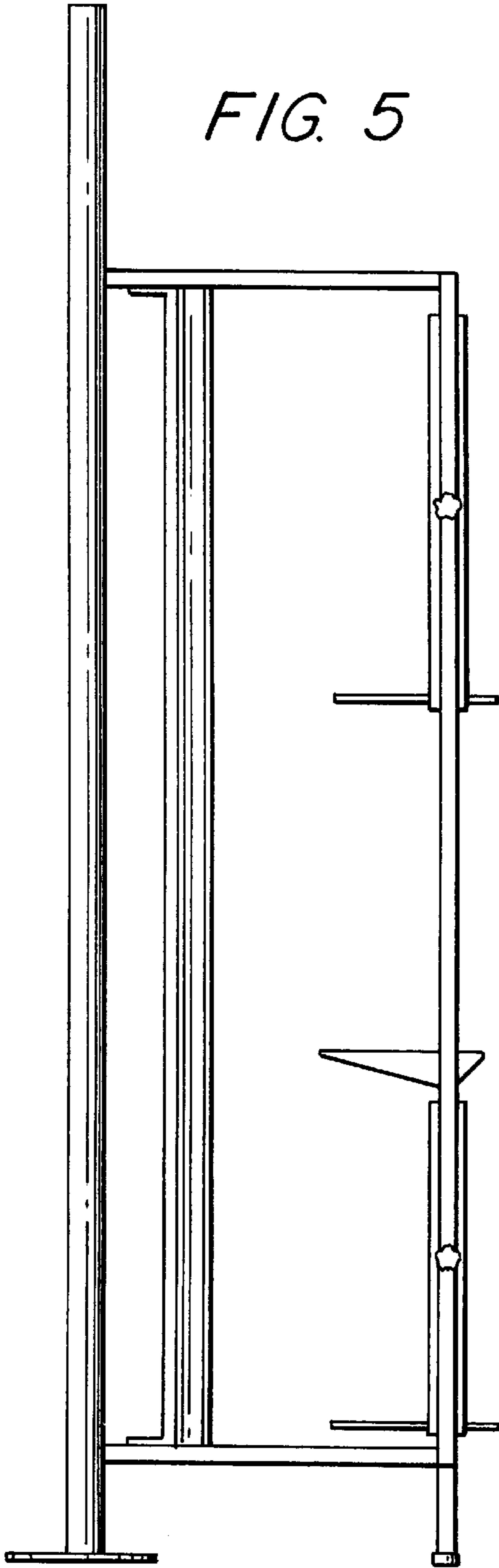

FIG. 5

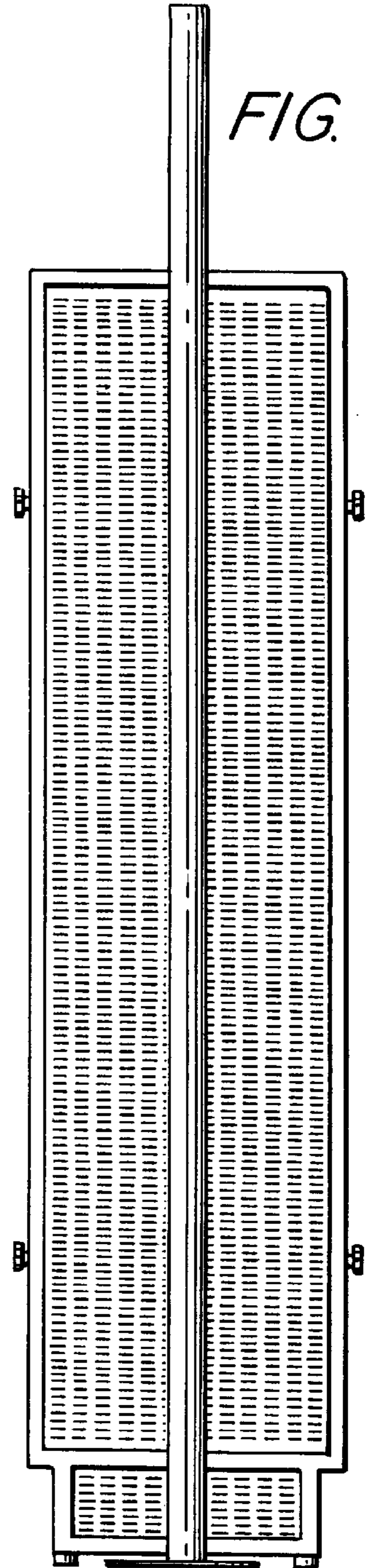

FIG. 6

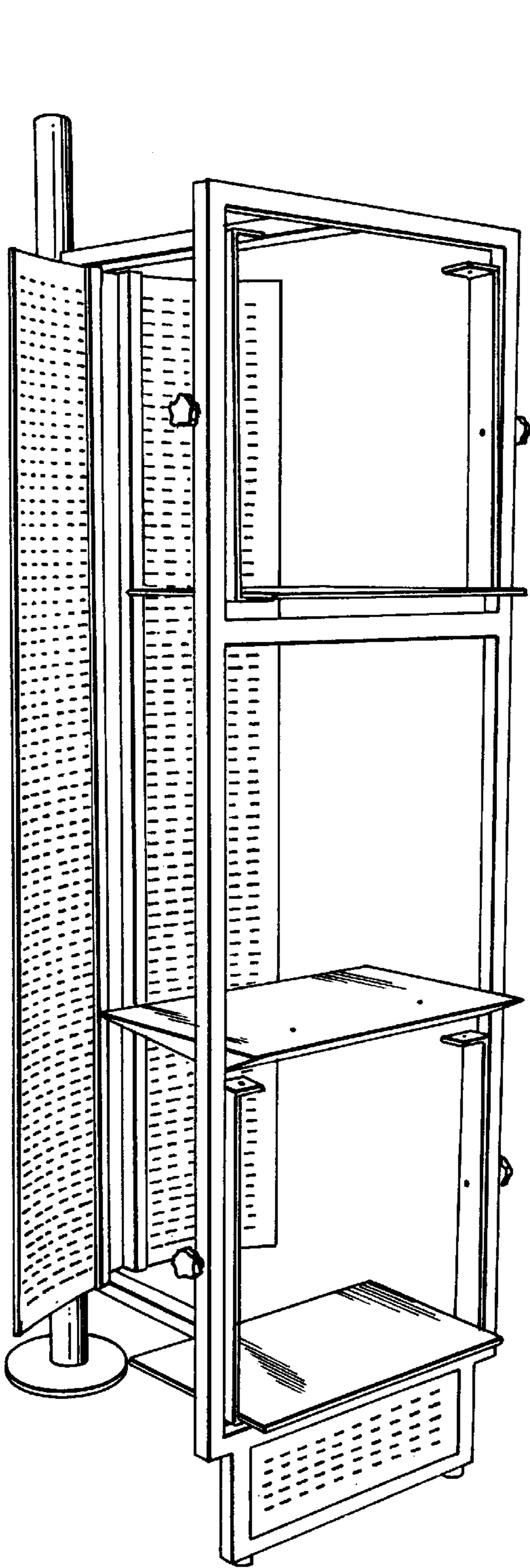

FIG. 7

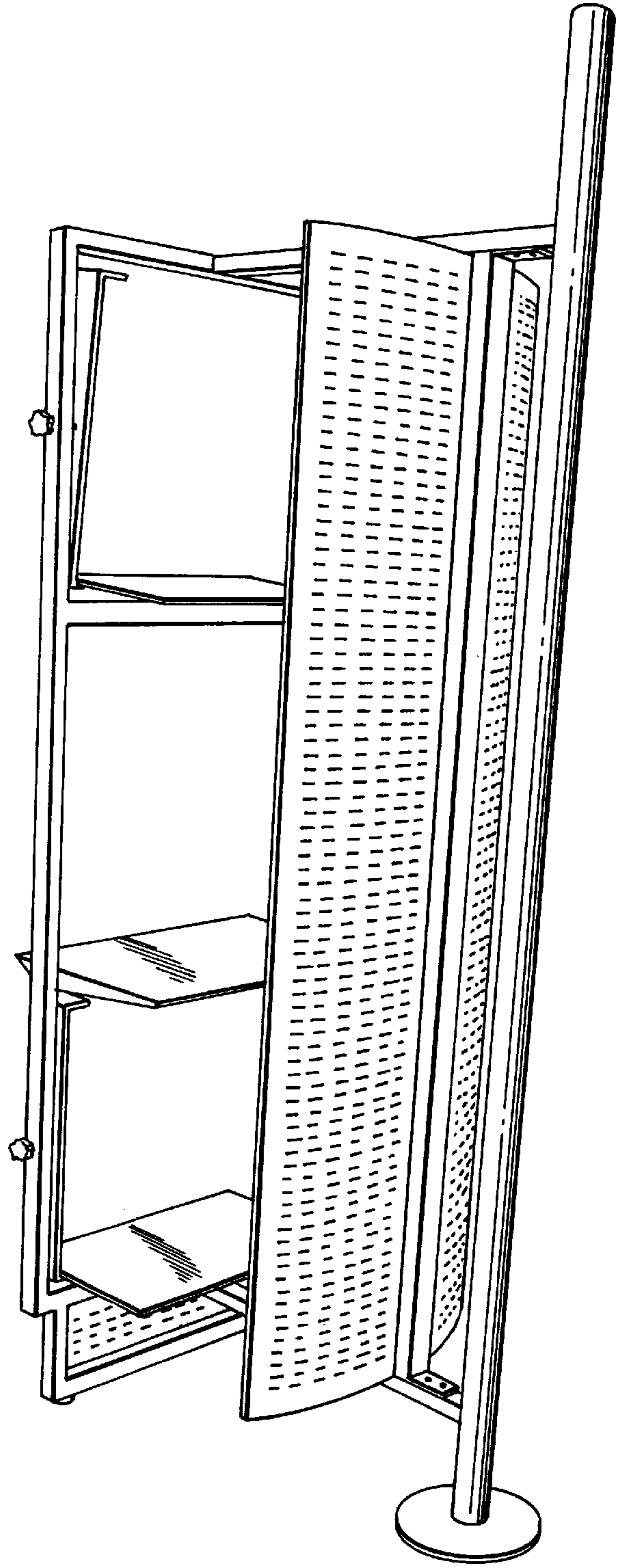

FIG. 8