



US00D399621S

United States Patent [19] Henke

[11] **Patent Number: Des. 399,621**
[45] **Date of Patent: **Oct. 13, 1998**

[54] **ERGONOMIC, SINGLE HAND, FOLDING PAINTER'S TOOL**

[75] Inventor: **David R. Henke**, Maple Grove, Minn.

[73] Assignee: **Warner Manufacturing Company**, Minneapolis, Minn.

[**] Term: **14 Years**

[21] Appl. No.: **74,031**

[22] Filed: **Jul. 23, 1997**

[51] **LOC (6) Cl.** **08-05**

[52] **U.S. Cl.** **D32/49; D8/99; 15/105**

[58] **Field of Search** **D32/40, 42, 46, D32/51; 15/105, 236.01, 236.03, 236.05, 236.07; 30/155, 157, 160, 161, 169; D8/98, 99, 101**

2,092,586	7/1937	Naumovich .	
2,213,071	11/1940	Keller .	
2,839,110	7/1958	Carpenter .	
3,774,252	11/1973	Cantales .	
4,095,337	6/1978	Pharr .	
4,271,592	6/1981	Höptner .	
4,805,303	2/1989	Gibbs .	
4,819,289	4/1989	Gibbs .	
4,890,387	1/1990	Canino .	
5,009,008	4/1991	Yablonovitch .	
5,044,079	9/1991	Gibbs .	
5,060,379	10/1991	Neely	30/161
5,063,627	11/1991	Marra .	
5,251,352	10/1993	Cullison .	
5,495,673	3/1996	Gardiner et al.	30/155
5,502,895	4/1996	Lemaire .	
5,546,625	8/1996	Mealey et al.	15/105
5,689,890	11/1997	Glesser	30/155 X

Primary Examiner—Susan J. Lucas
Assistant Examiner—Cynthia Ramirez
Attorney, Agent, or Firm—Mechant, Gould, Smith, Edell, Welter, & Schmidt, P.A.

[56] **References Cited**

U.S. PATENT DOCUMENTS

28,738	5/1860	Hamlis .	
D. 150,111	7/1948	Crum	D8/99
180,187	7/1876	Bartlett .	
247,903	10/1881	Goss .	
D. 280,287	8/1985	Collins	D8/99
D. 286,457	10/1986	Thomas	D32/49
D. 310,621	9/1990	Thompson	D8/99
322,991	7/1885	Stowell .	
D. 373,716	9/1996	Keys et al.	D8/99 X
D. 385,173	10/1997	McWillis	D8/99
508,273	11/1893	Brauch .	
699,207	5/1902	Moe .	
825,063	7/1906	Lawbaugh .	
832,455	6/1906	Christensen .	
1,015,026	1/1912	Jackson et al. .	

[57] **CLAIM**

The ornamental design for an ergonomic, single hand, folding painter's tool, as shown and described.

DESCRIPTION

FIG. 1 is a perspective view of a ergonomic, single hand, folding painter's tool showing my new design; FIG. 2 is an elevational view of one side of the tool; FIG. 3 is an elevational view of the opposite side of the tool; FIG. 4 is a top plan view of the tool; FIG. 5 is a bottom plan view of the tool; FIG. 6 is a front elevational view of the tool; and, FIG. 7 is a rear elevational view of the tool.

1 Claim, 2 Drawing Sheets

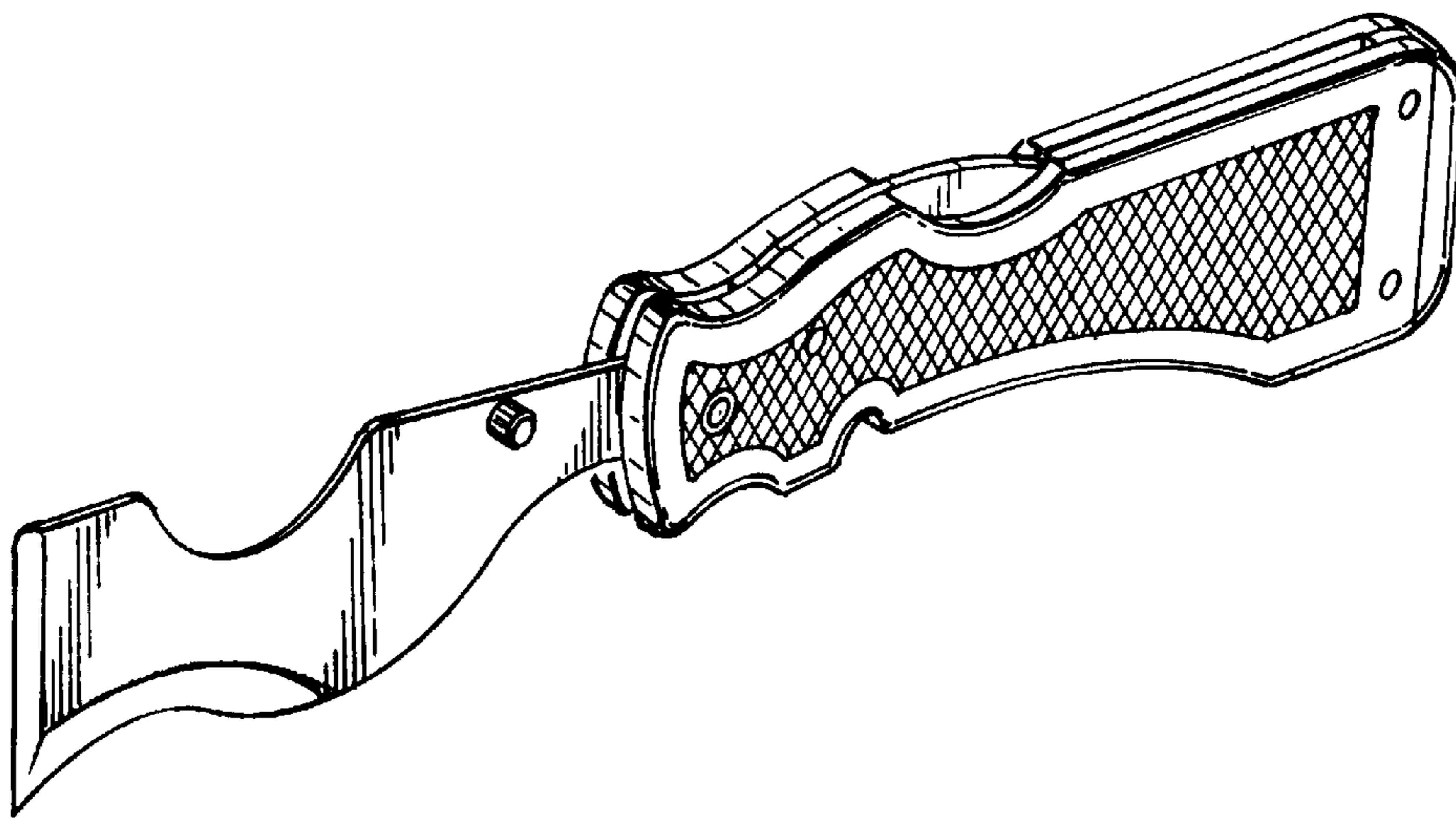

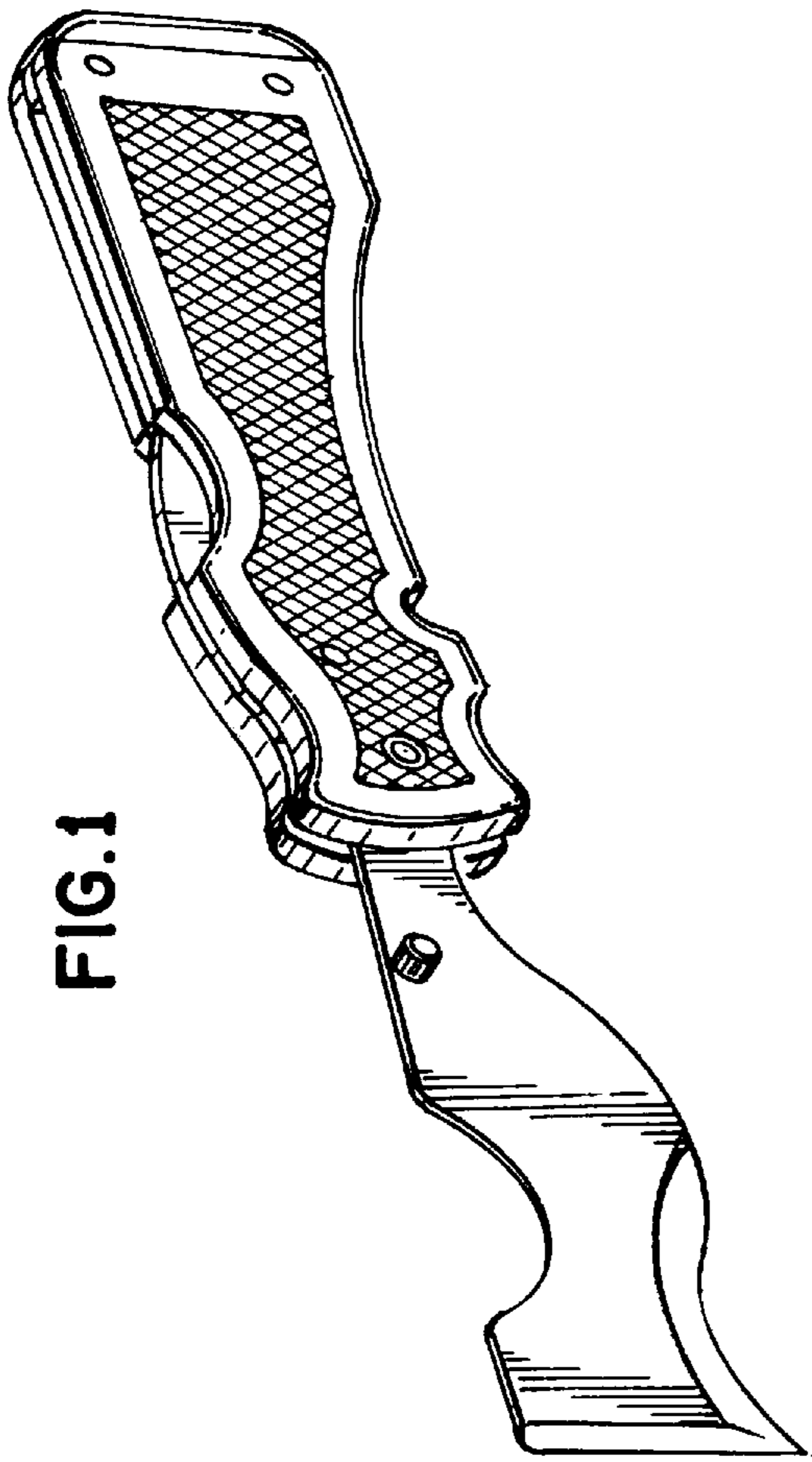

FIG. 1

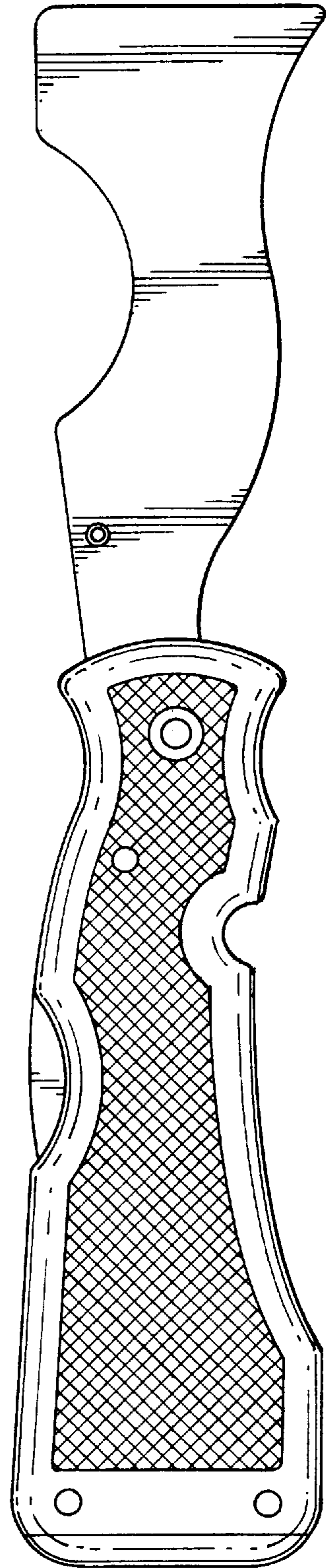

FIG. 3

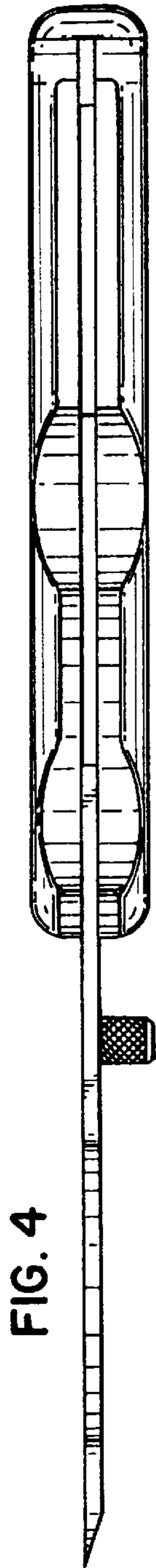

FIG. 4

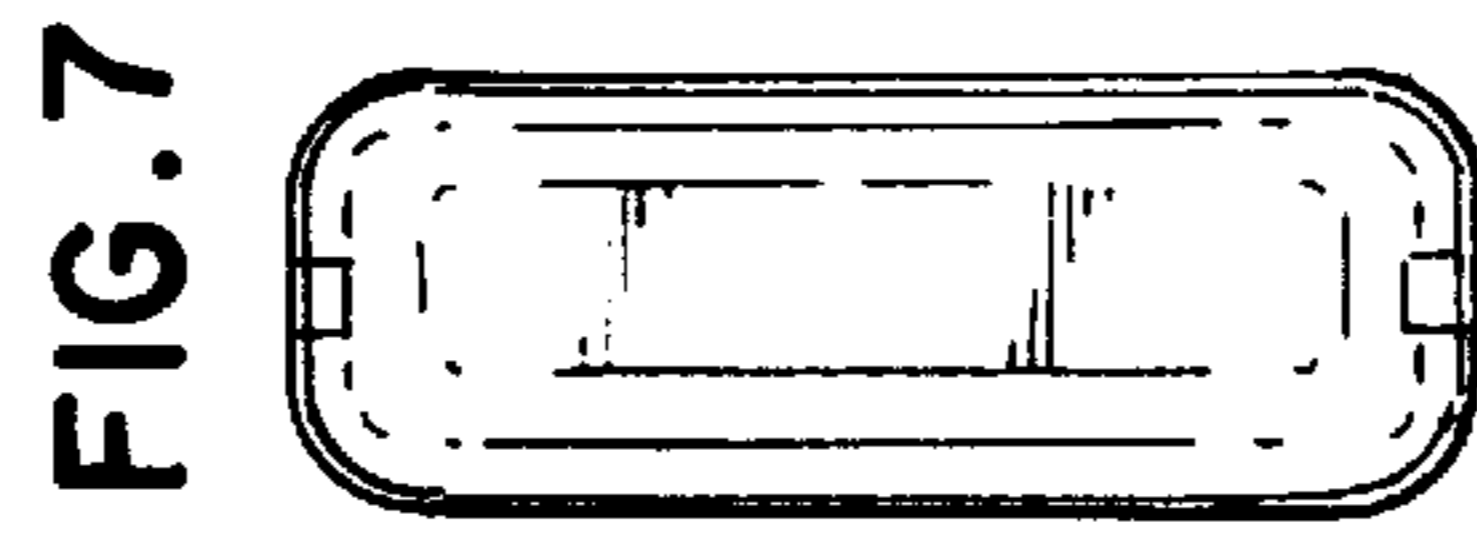

FIG. 7

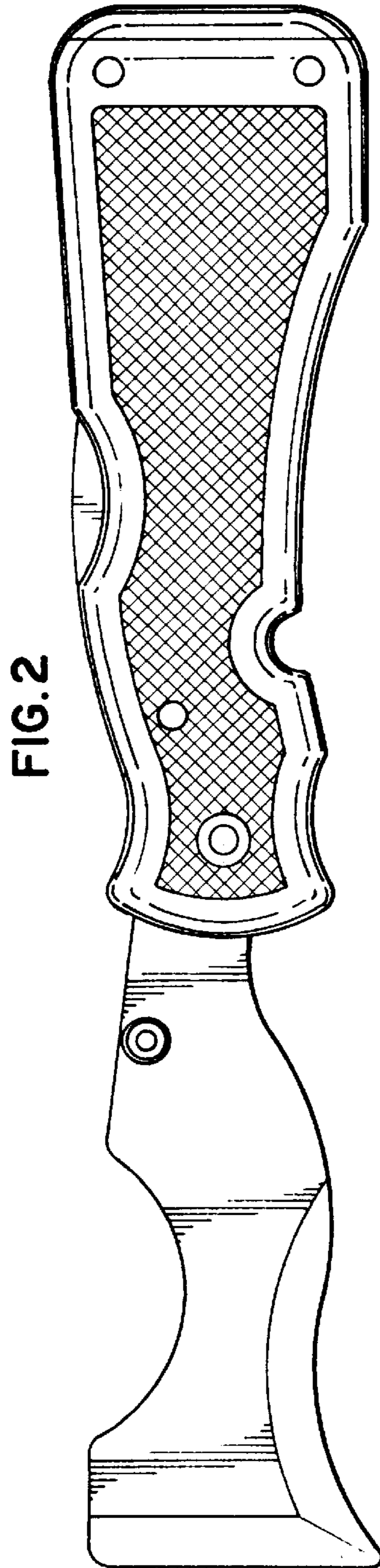

FIG. 2

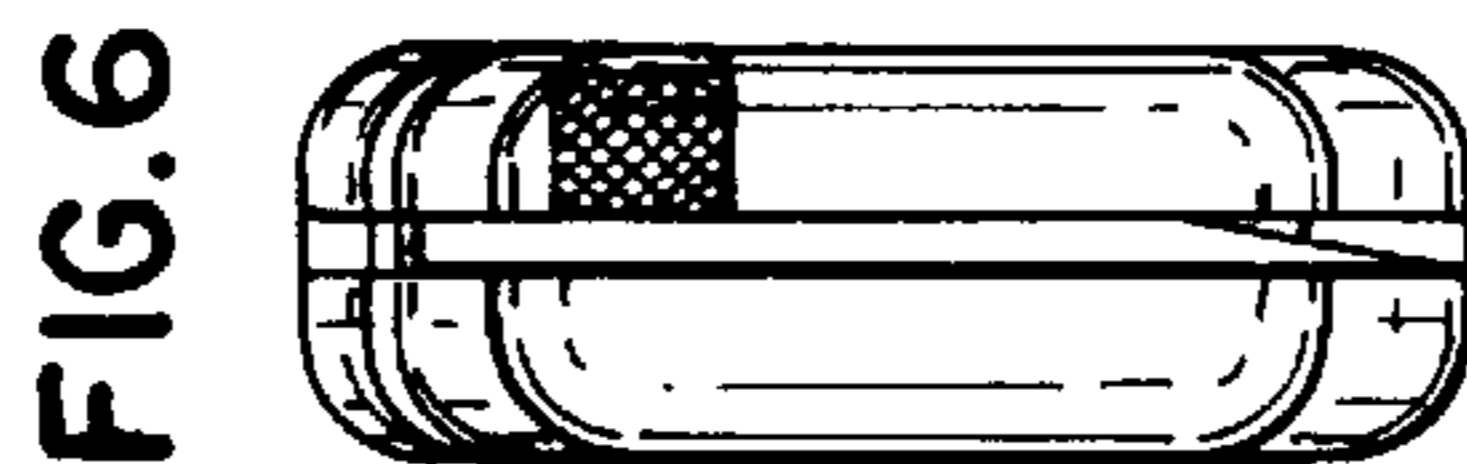

FIG. 6

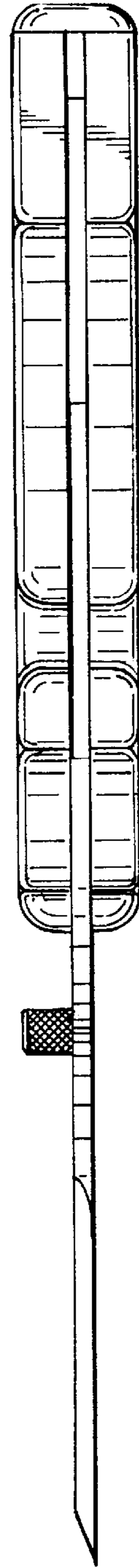

FIG. 5