



US00D399600S

United States Patent [19]

Bowen et al.

[11] Patent Number: **Des. 399,600**

[45] Date of Patent: ****Oct. 13, 1998**

[54] **HAND-HELD SMOKER'S ACCESSORY**

[75] Inventors: **Larry Bowen**, Orangeville; **Stanislav M. Snidr**; **Wayne B. Keefe**, both of Mississauga, all of Canada

[73] Assignee: **1149235 Ontario Inc.**, Ontario, Canada

[**] Term: **14 Years**

[21] Appl. No.: **71,620**

[22] Filed: **Jun. 3, 1997**

[30] **Foreign Application Priority Data**

Dec. 4, 1996 [CA] Canada 1996-2769

[51] **LOC (6) Cl.** **27-99**

[52] **U.S. Cl.** **D27/194; D27/163; D27/172**

[58] **Field of Search** 131/202, 203, 131/206, 207, 210, 211; D27/163, 172, 187, 183, 186, 189, 194, 192; 128/202.21; 206/329, 330, 249, 242, 241, 246, 236, 265; 431/253

[56] **References Cited**

U.S. PATENT DOCUMENTS

D. 376,869 12/1996 Makoto D27/157
D. 376,870 12/1996 Ichikawa D27/157

4,052,179	10/1977	Kirk .	
4,637,407	1/1987	Bonanno et al. .	
4,790,332	12/1988	Wallace .	
4,993,435	2/1991	McCann	131/330
5,160,518	11/1992	Vega, Jr. .	
5,388,595	2/1995	Shafer	131/329
5,499,636	3/1996	Baggett, Jr. et al. .	
5,529,078	6/1996	Rehder et al. .	
5,638,833	6/1997	Bowen et al.	131/202

Primary Examiner—Susan J. Lucas
Assistant Examiner—Jennifer Rivard
Attorney, Agent, or Firm—Banner & Witcoff, Ltd.

[57] **CLAIM**

The ornamental design for a hand-held smoker's accessory, as shown and described.

DESCRIPTION

FIG. 1 is an exploded perspective view of a hand-held smoker's accessory showing our new design with the cap shown separated from the base;
FIG. 2 is a perspective view thereof showing the cap attached to the base;
FIG. 3 is a front view of FIG. 1;
FIG. 4 is a side view showing the left side of FIG. 1;
FIG. 5 is a top plan view of FIG. 2;
FIG. 6 is a rear view of FIG. 1;
FIG. 7 is a side view showing the right side of FIG. 1; and,
FIG. 8 is a bottom plan view of FIG. 2.

1 Claim, 3 Drawing Sheets

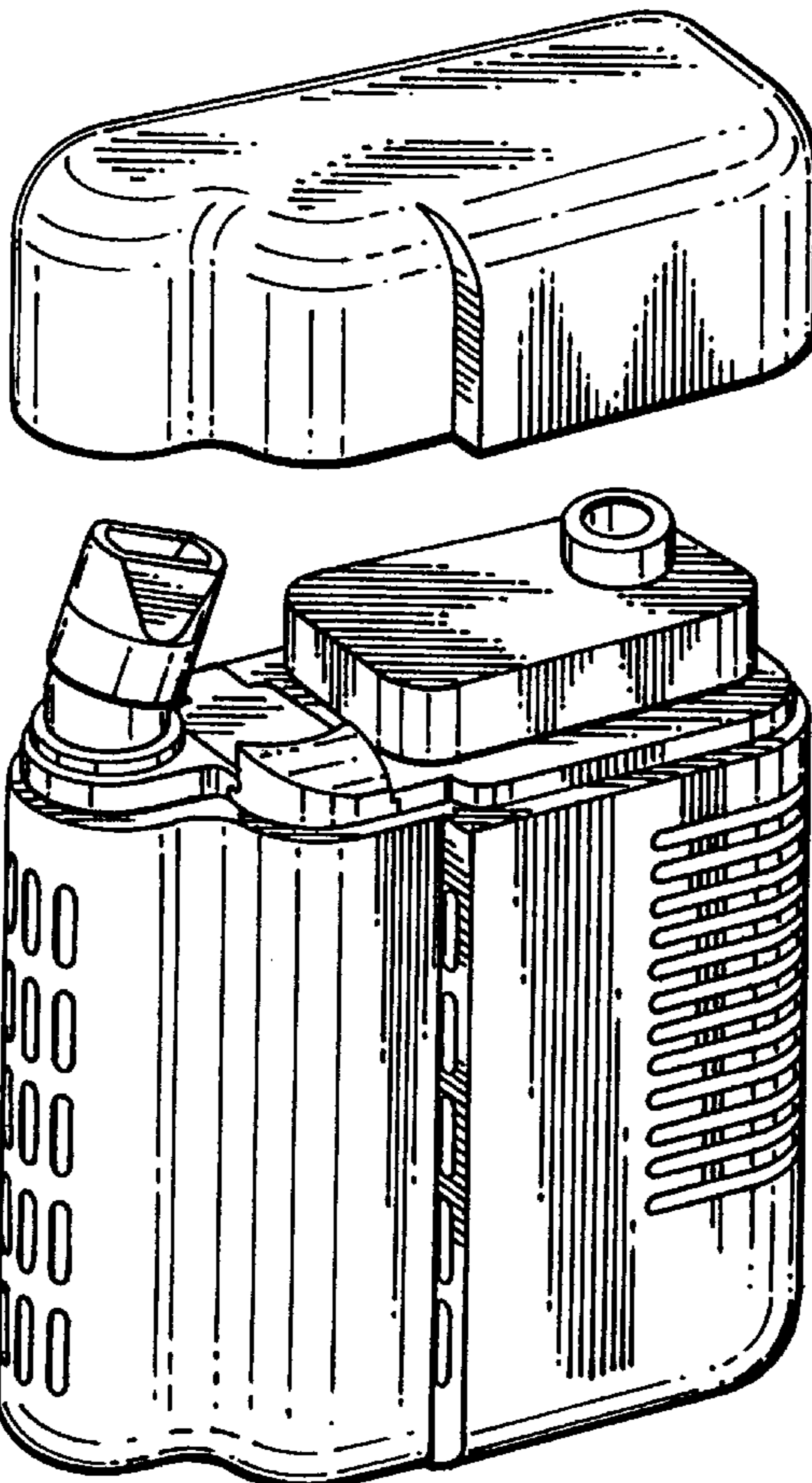

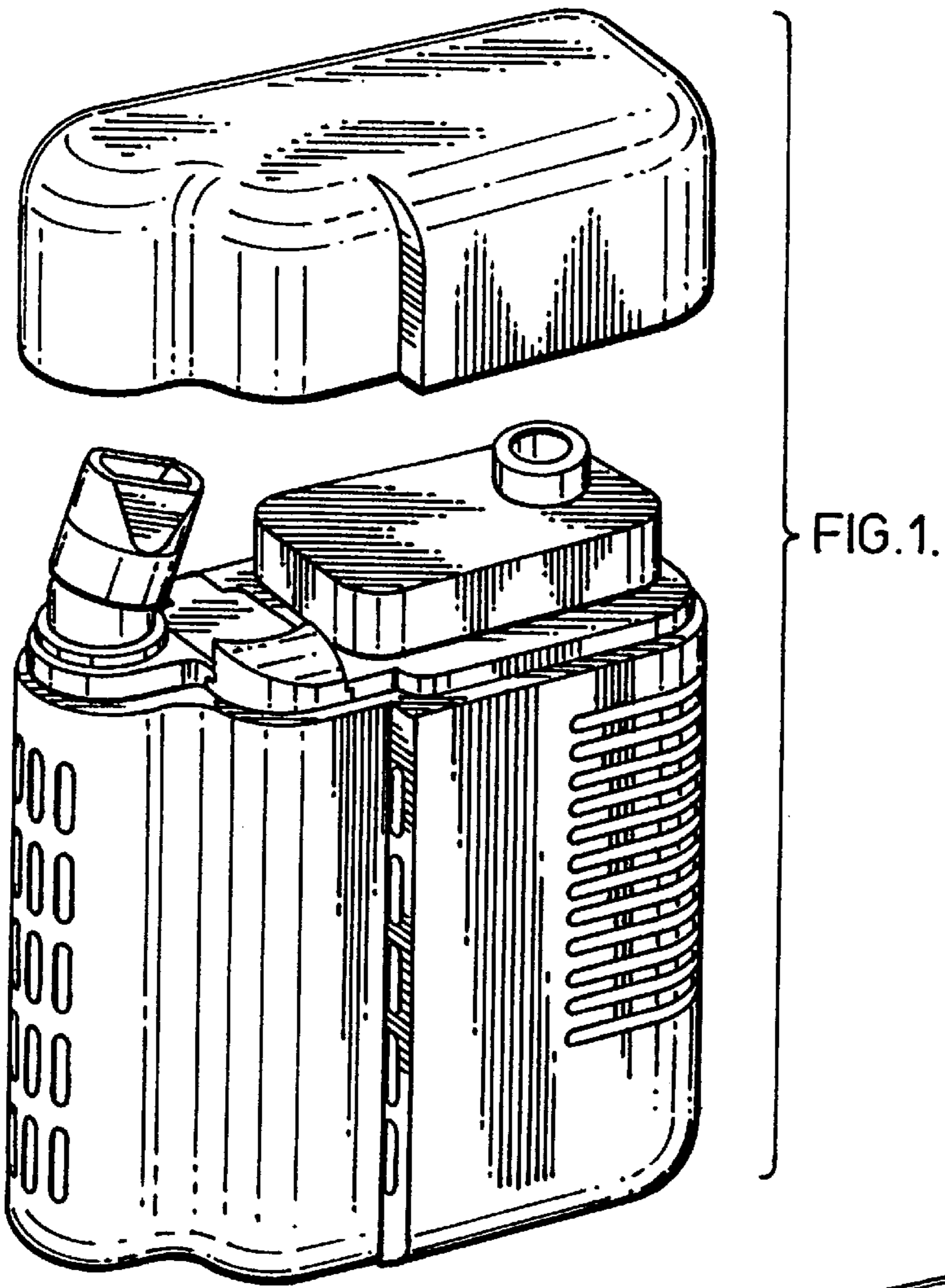

FIG. 2.

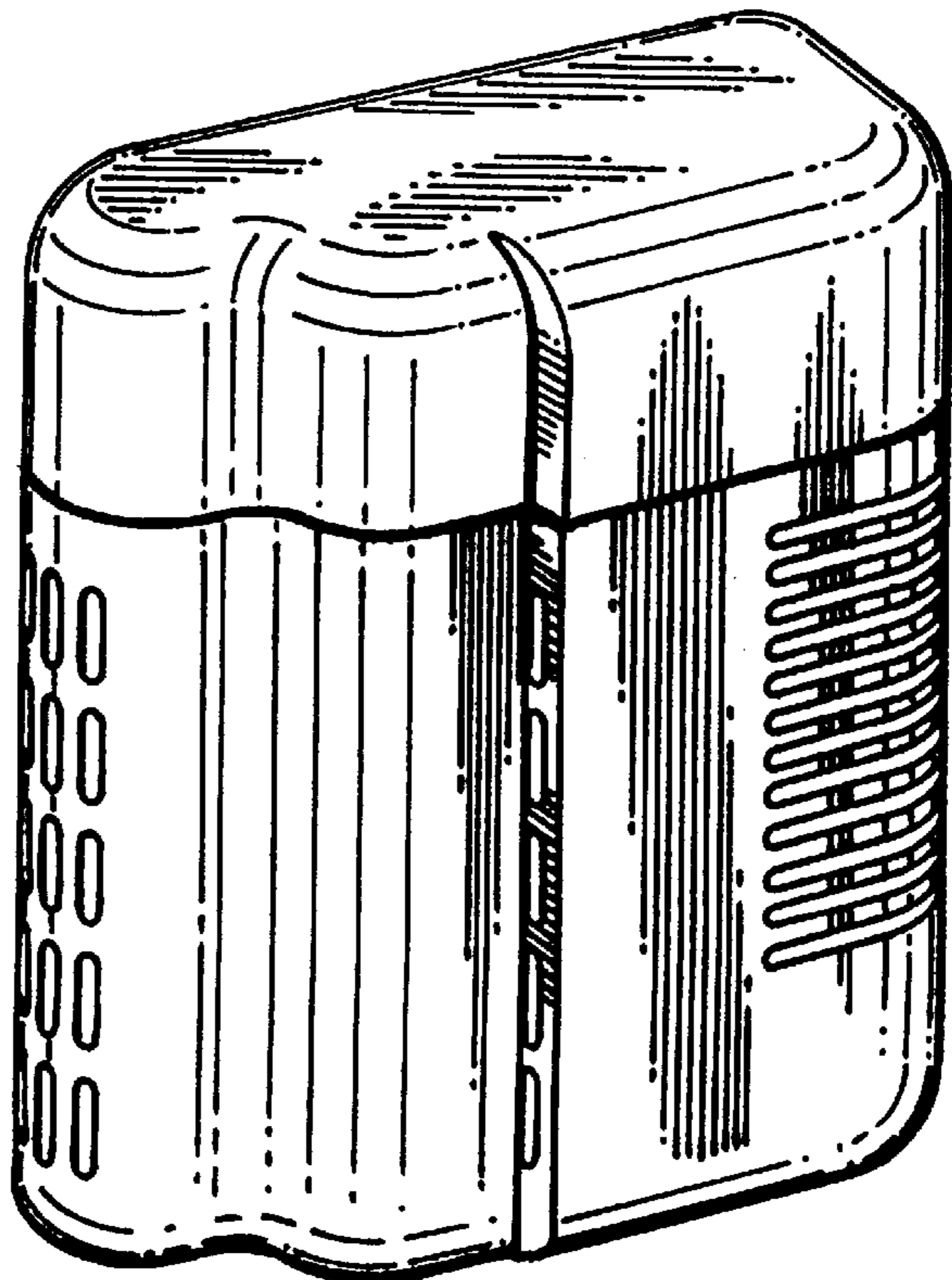

FIG. 3.

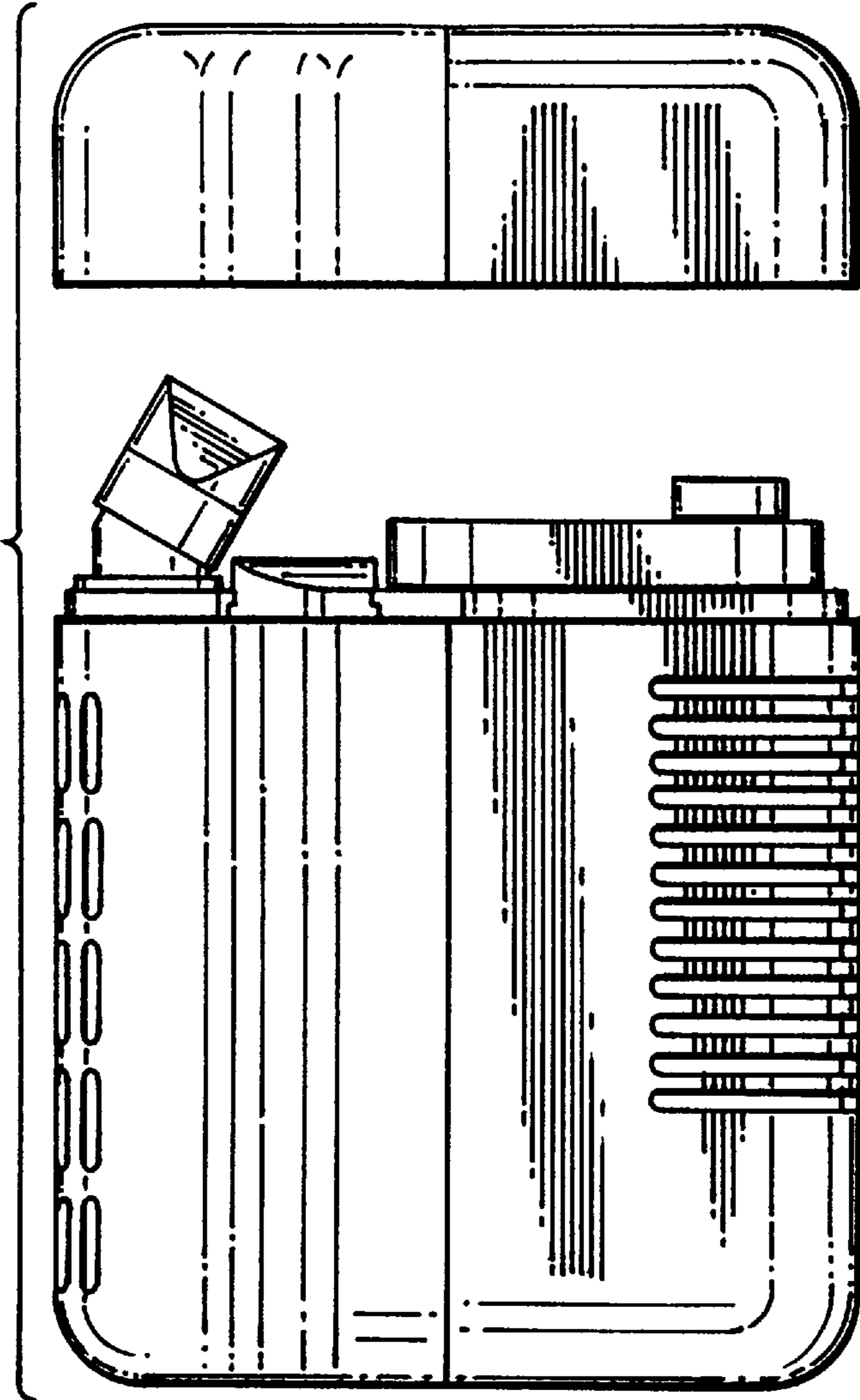

FIG. 4.

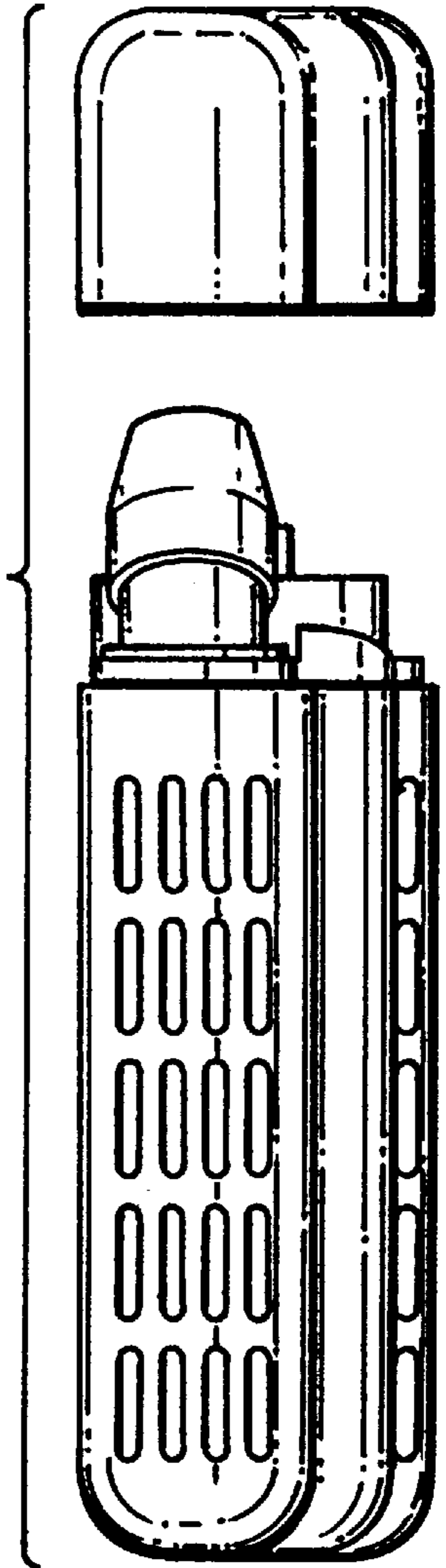

FIG. 5.

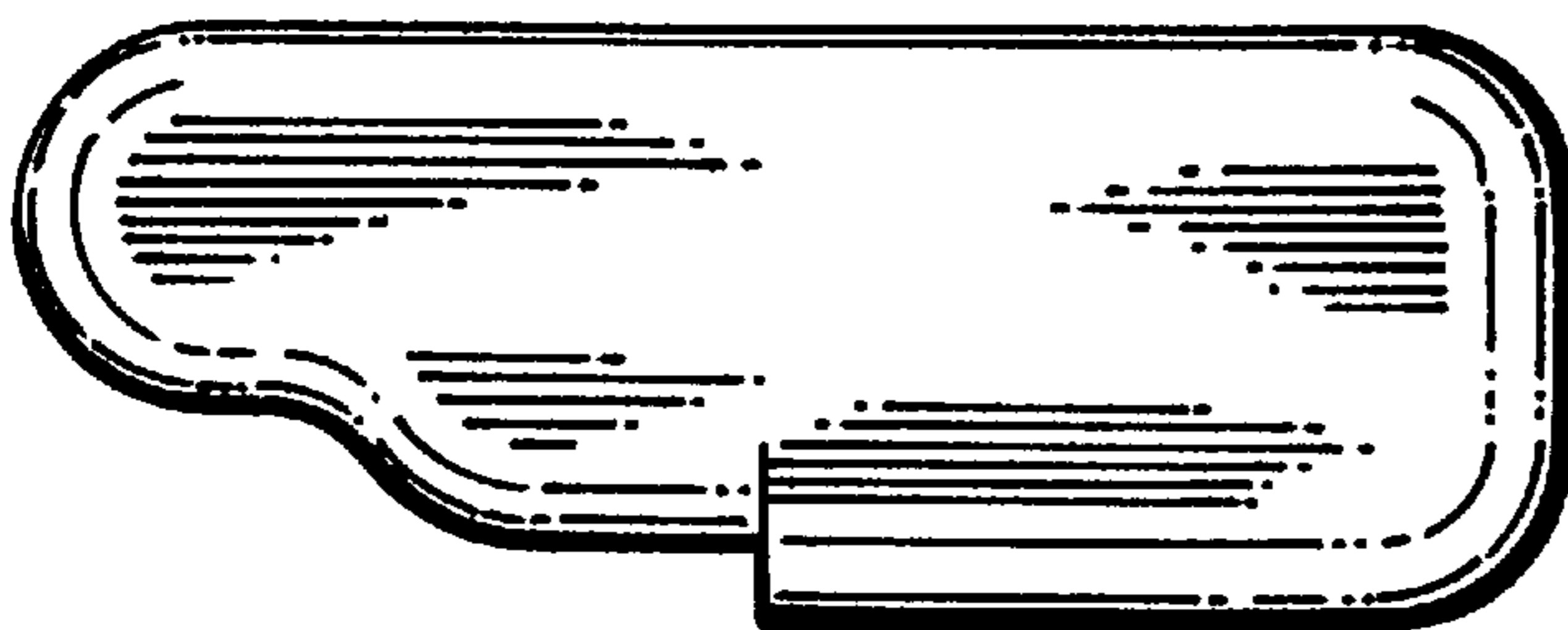

FIG. 6.

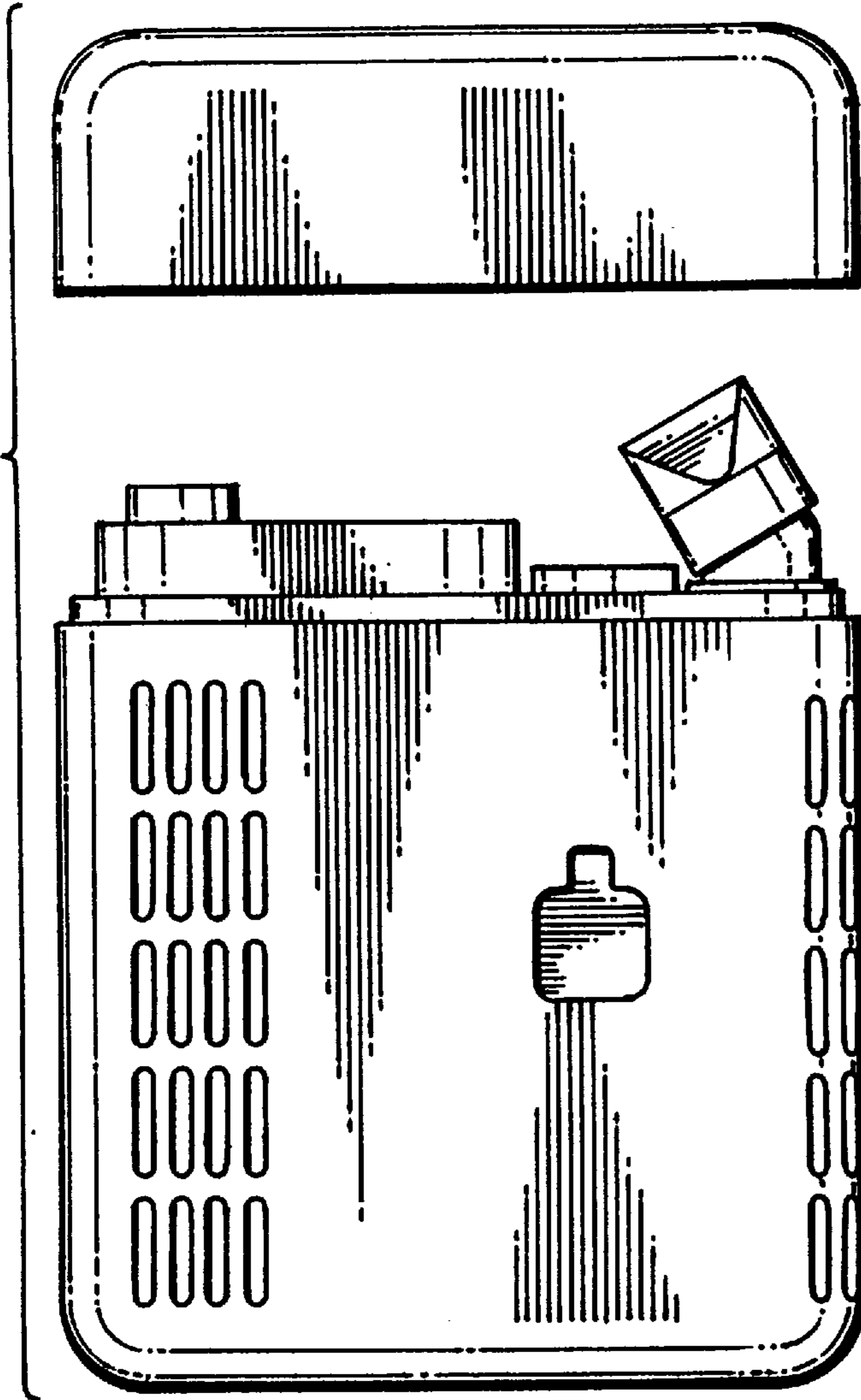

FIG. 7.

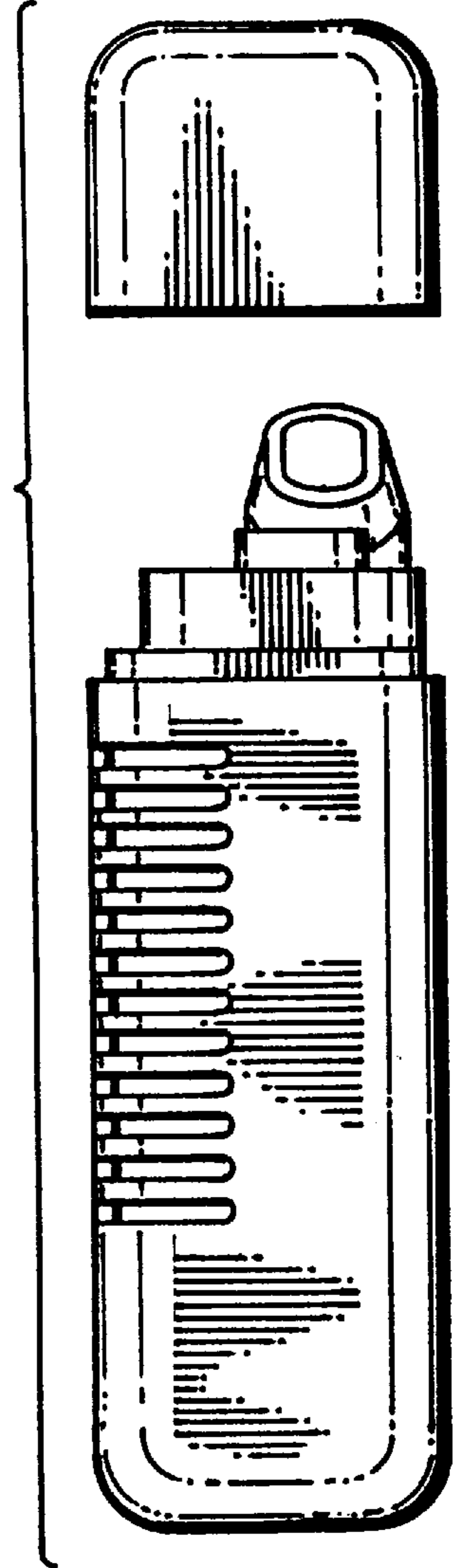

FIG. 8.

