



US00D399518S

**United States Patent** [19]  
**Pankhurst**

[11] **Patent Number: Des. 399,518**

[45] **Date of Patent: \*\*Oct. 13, 1998**

[54] **FOLDING PHOTOGRAPHIC APPARATUS**

*Attorney, Agent, or Firm—Leslie Payne*

[75] Inventor: **Paul Hayes Pankhurst**, London, England

[57] **CLAIM**

The ornamental design for a folding photographic apparatus, as shown and described.

[73] Assignee: **Polaroid Corporation**, Cambridge, Mass.

**DESCRIPTION**

[\*\*] Term: **14 Years**

[21] Appl. No.: **64,090**

[22] Filed: **Dec. 10, 1996**

[51] **LOC (6) Cl.** ..... **16-01**

[52] **U.S. Cl.** ..... **D16/211**

[58] **Field of Search** ..... D16/200–204,  
D16/208, 209, 211, 212, 213, 216–218;  
396/30–47, 348–350, 535–543, 176–178

FIG. 1 is a left front perspective view of a folding photographic apparatus showing my design in its folded condition;

FIG. 2 is an enlarged folded front view thereof;

FIG. 3 is an enlarged folded rear view thereof;

FIG. 4 is an enlarged left side view thereof;

FIG. 5 is an enlarged right side view thereof;

FIG. 6 is an enlarged top plan view thereof;

FIG. 7 is an enlarged bottom plan view thereof;

FIG. 8 is a left front perspective view thereof in an erect condition;

FIG. 9 is an enlarged erect front view thereof;

FIG. 10 is an enlarged erect rear view thereof;

FIG. 11 is an enlarged erect left side view thereof;

FIG. 12 is an enlarged erect right side; and,

FIG. 13 is an enlarged erect top plan view thereof.

[56] **References Cited**

**U.S. PATENT DOCUMENTS**

D. 279,574	7/1985	Conner et al. ....	D16/211
D. 315,569	3/1991	Betts et al. ....	D16/211
D. 382,579	8/1997	Chueh ....	D16/211
D. 389,165	1/1998	Betts et al. ....	D16/211
4,389,110	6/1983	Pizzuti ....	396/178
4,723,140	2/1988	Whiteside et al. ....	396/39

**OTHER PUBLICATIONS**

IID, p. 66 (Polaroid Spectra System) Jan. 1987.

*Primary Examiner—Sandra L. Morris*

*Assistant Examiner—Adir Aronovich*

**1 Claim, 13 Drawing Sheets**

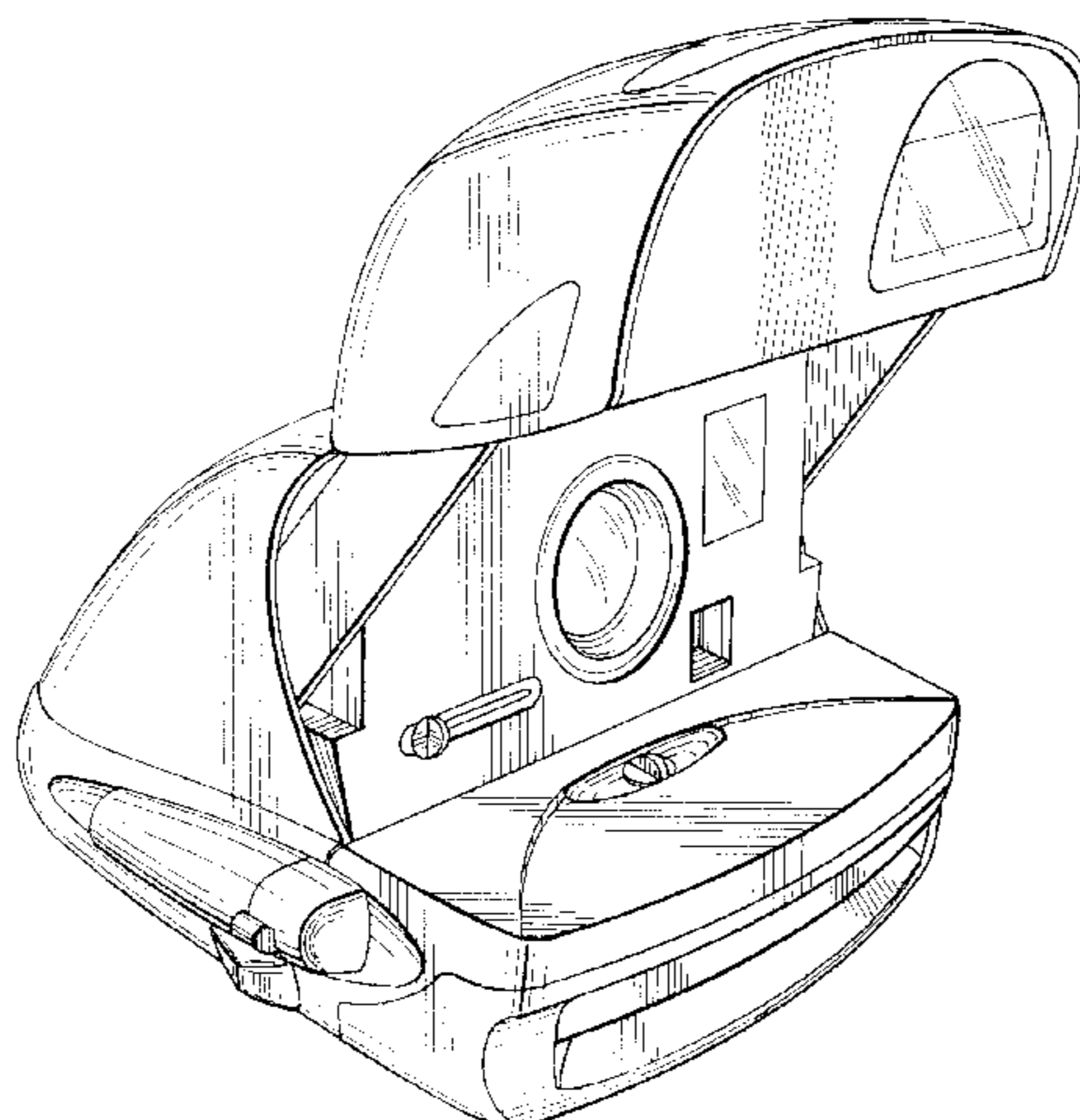
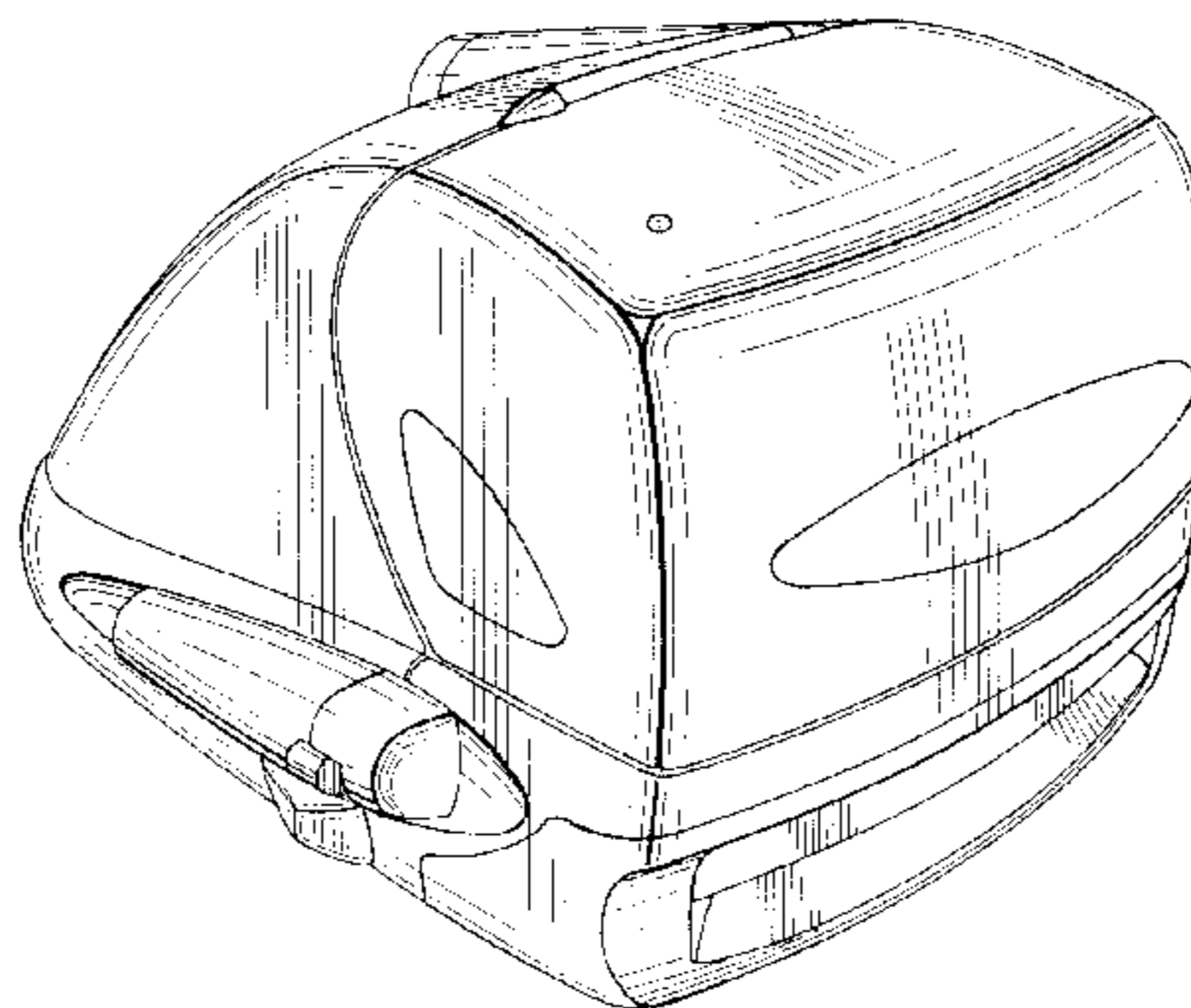

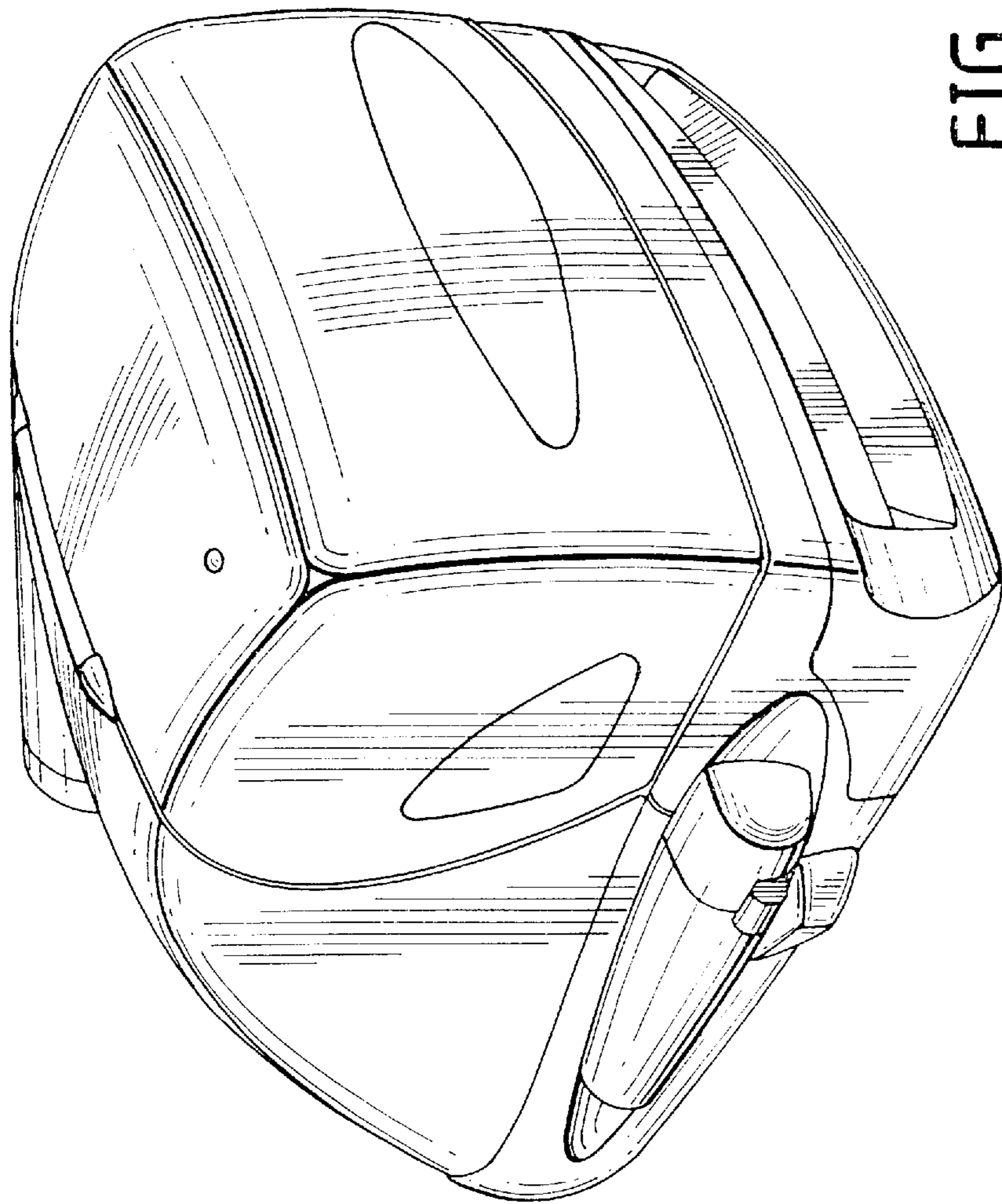

FIG. 1

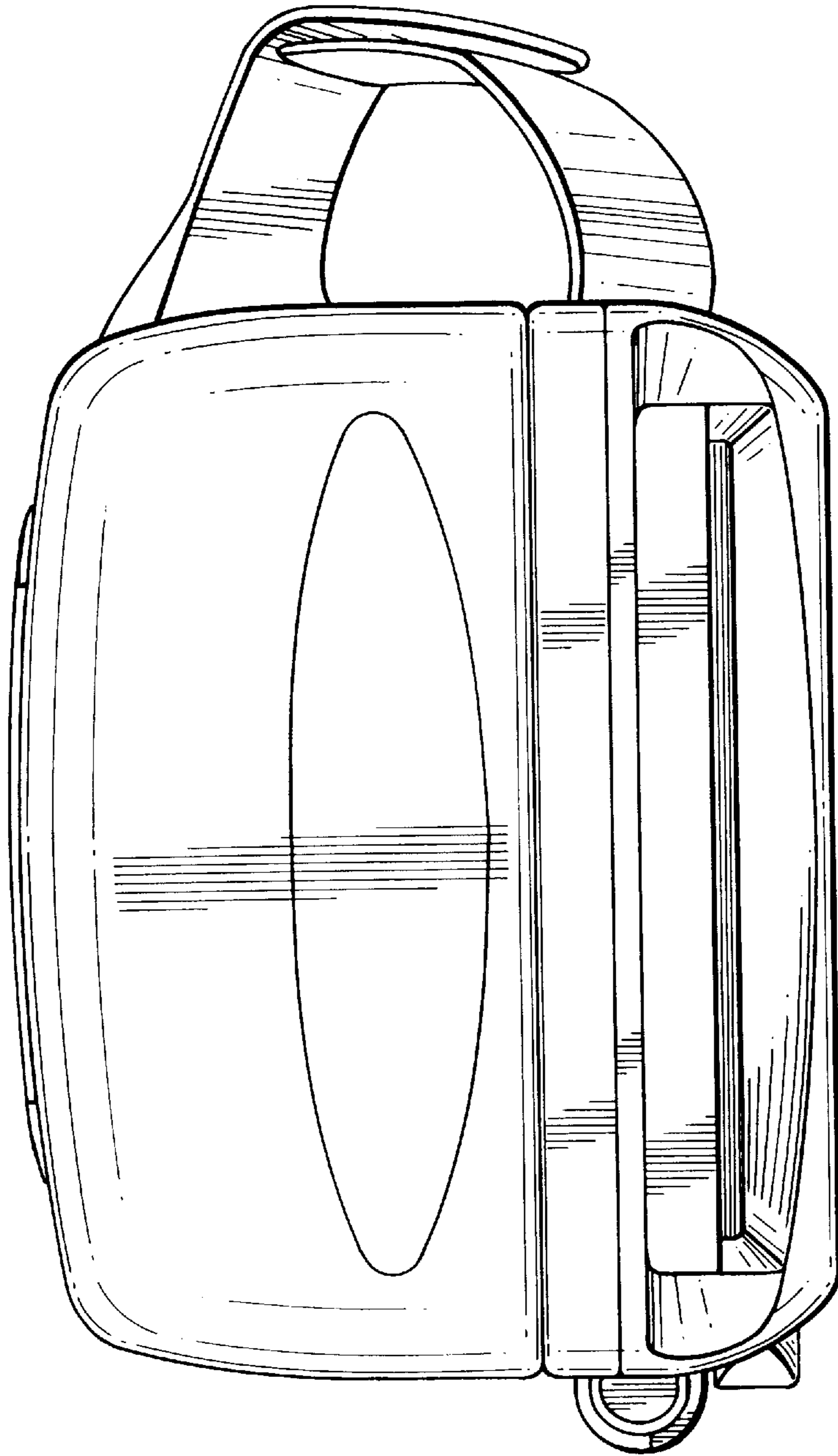

FIG. 2

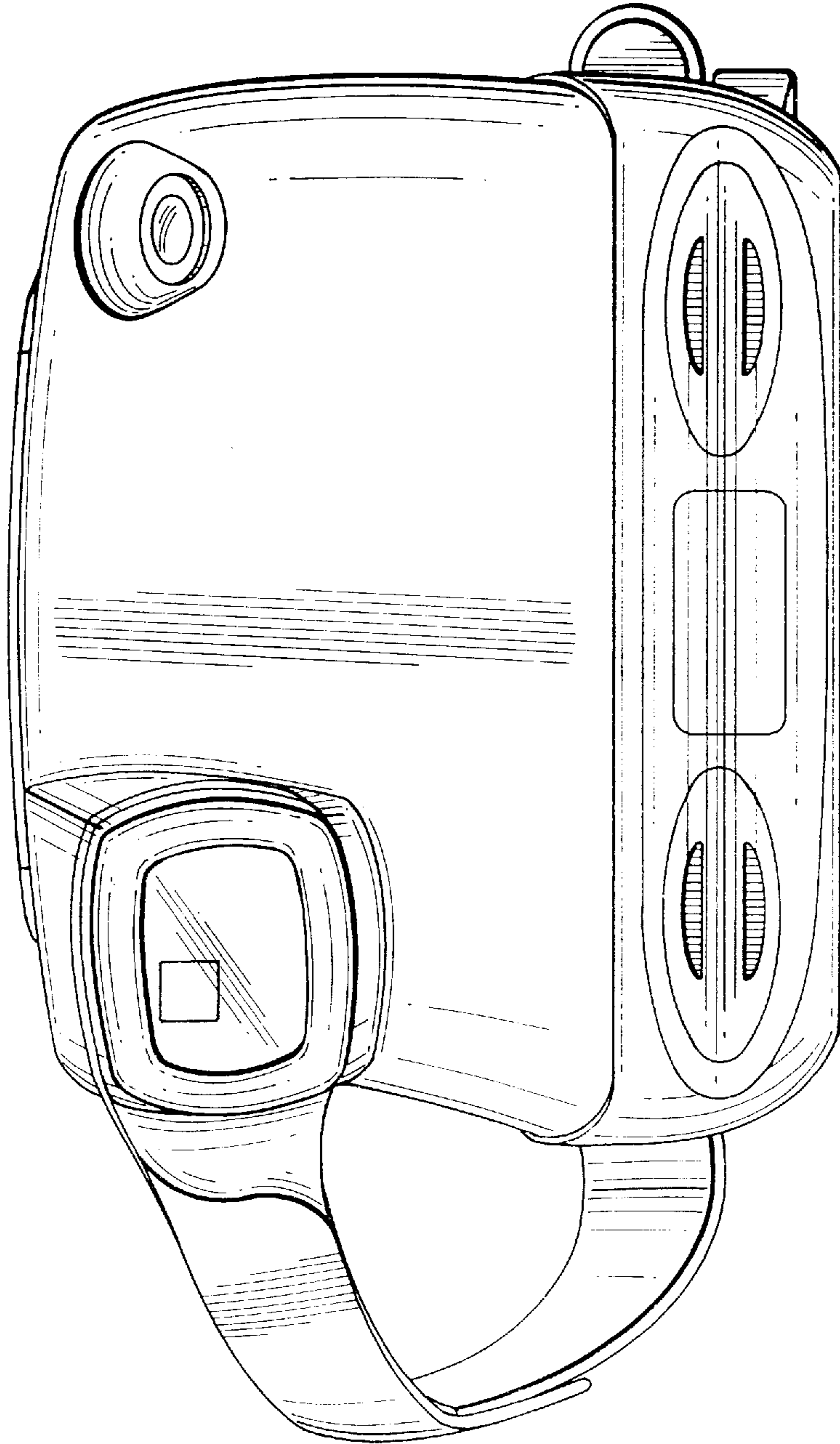

FIG. 3

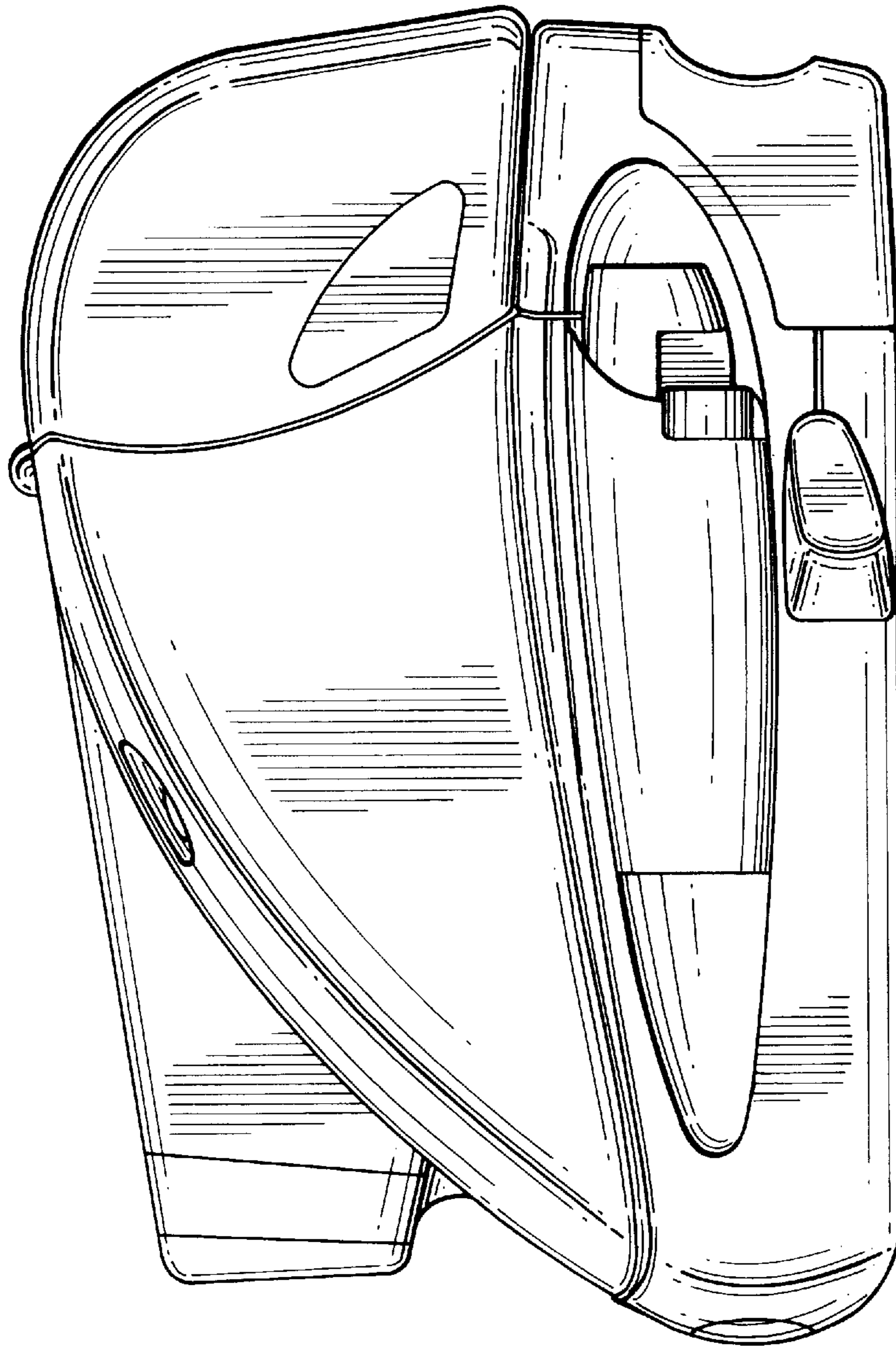

FIG. 4

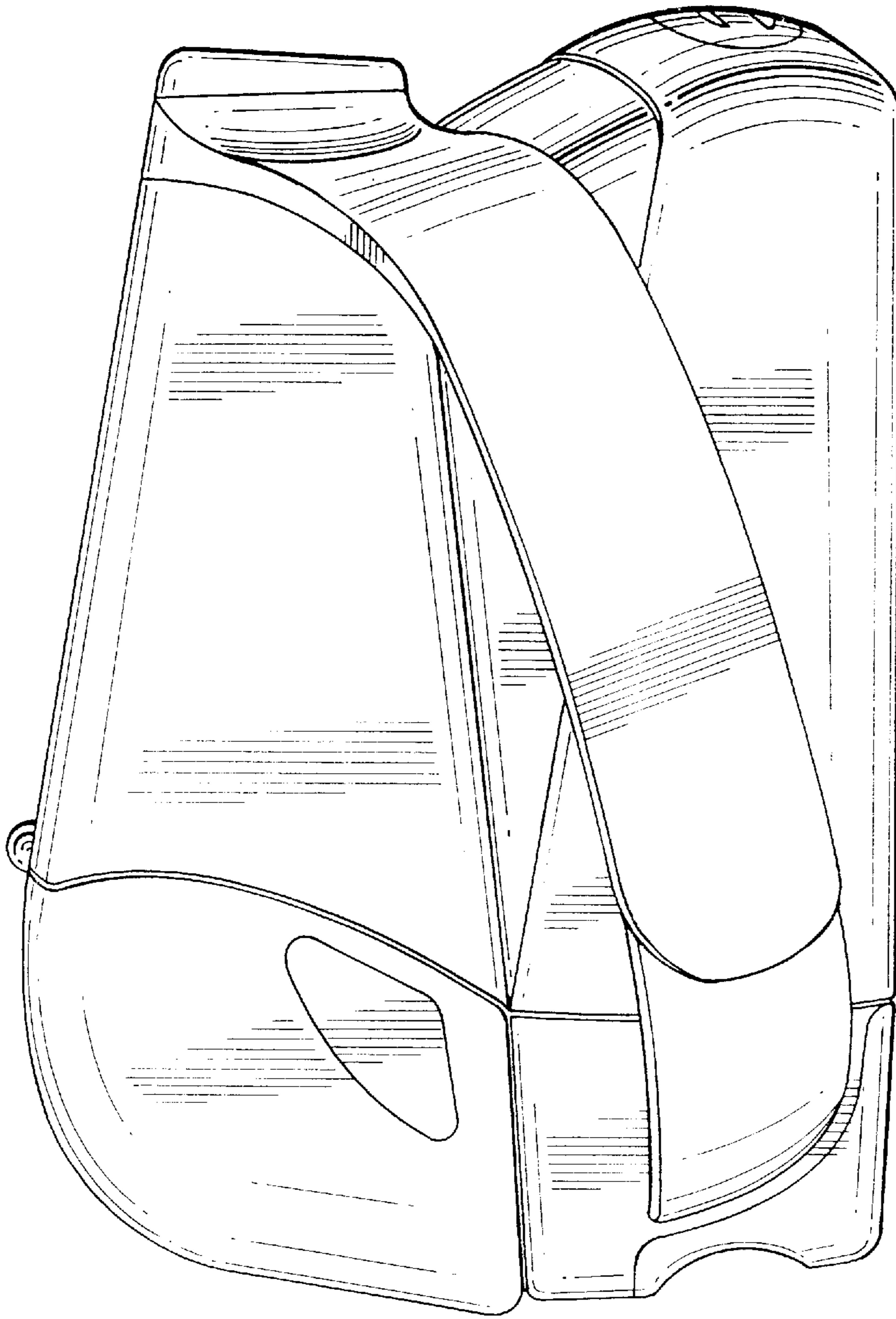

FIG. 5

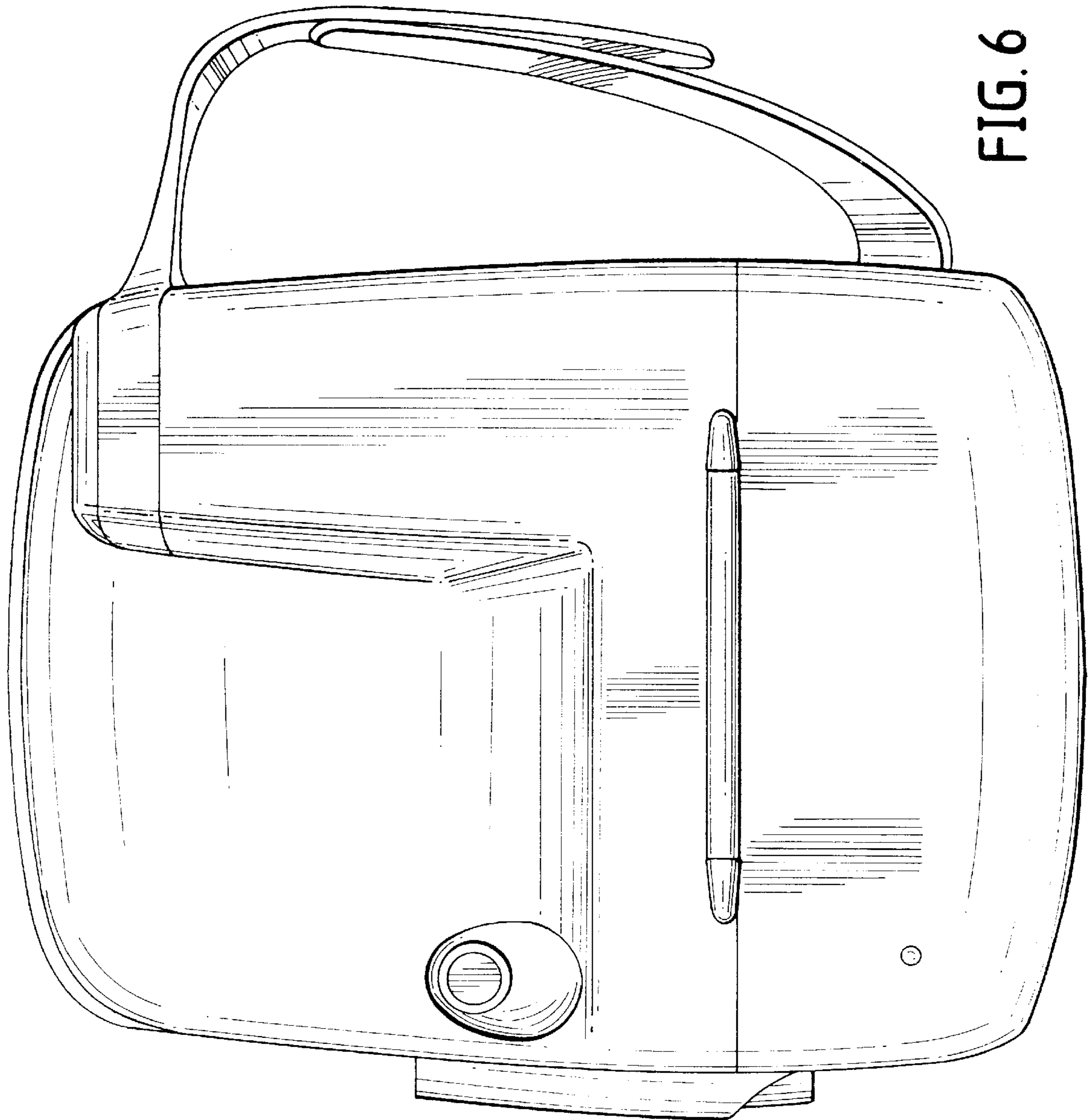

FIG. 6

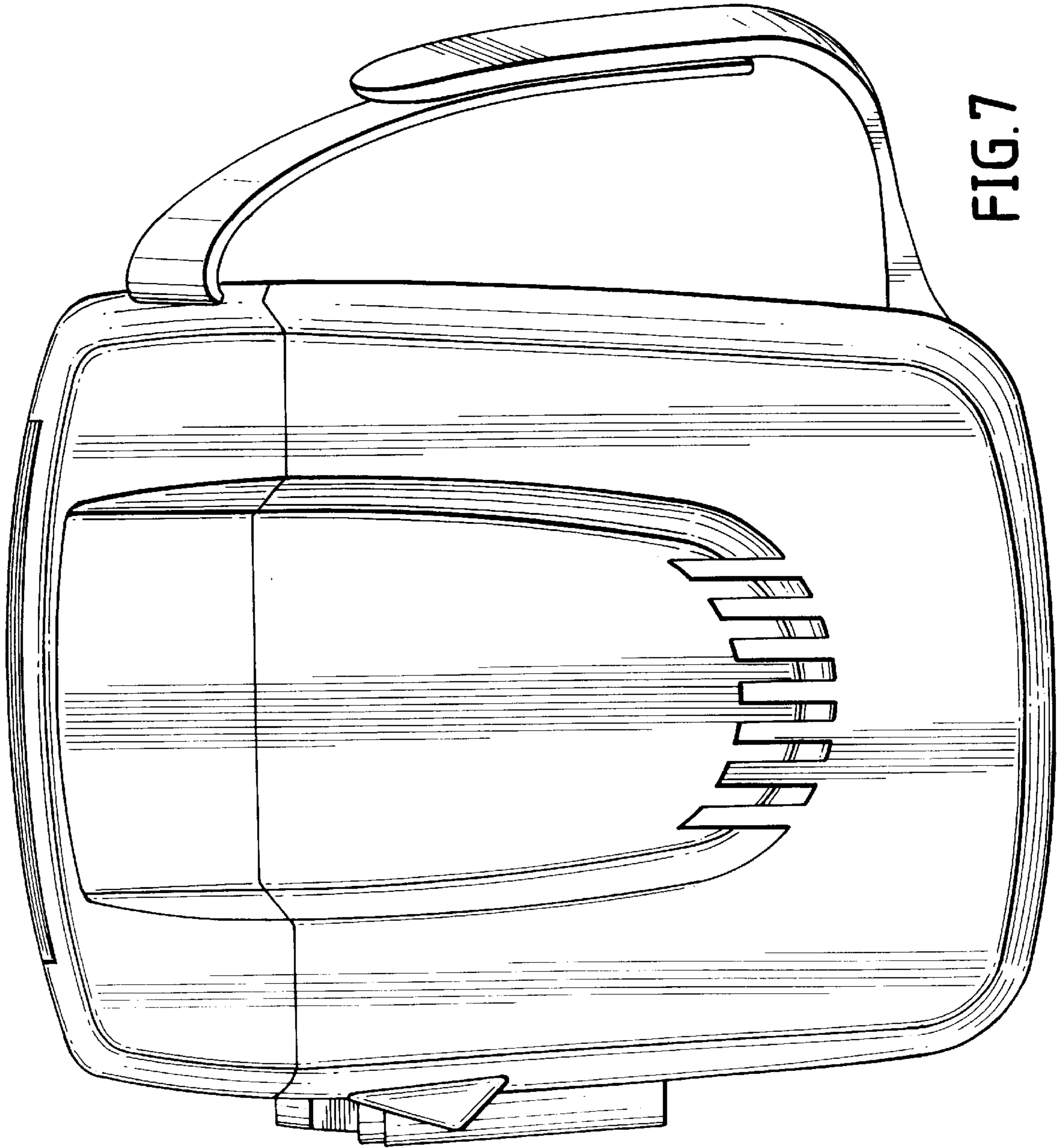

FIG. 7



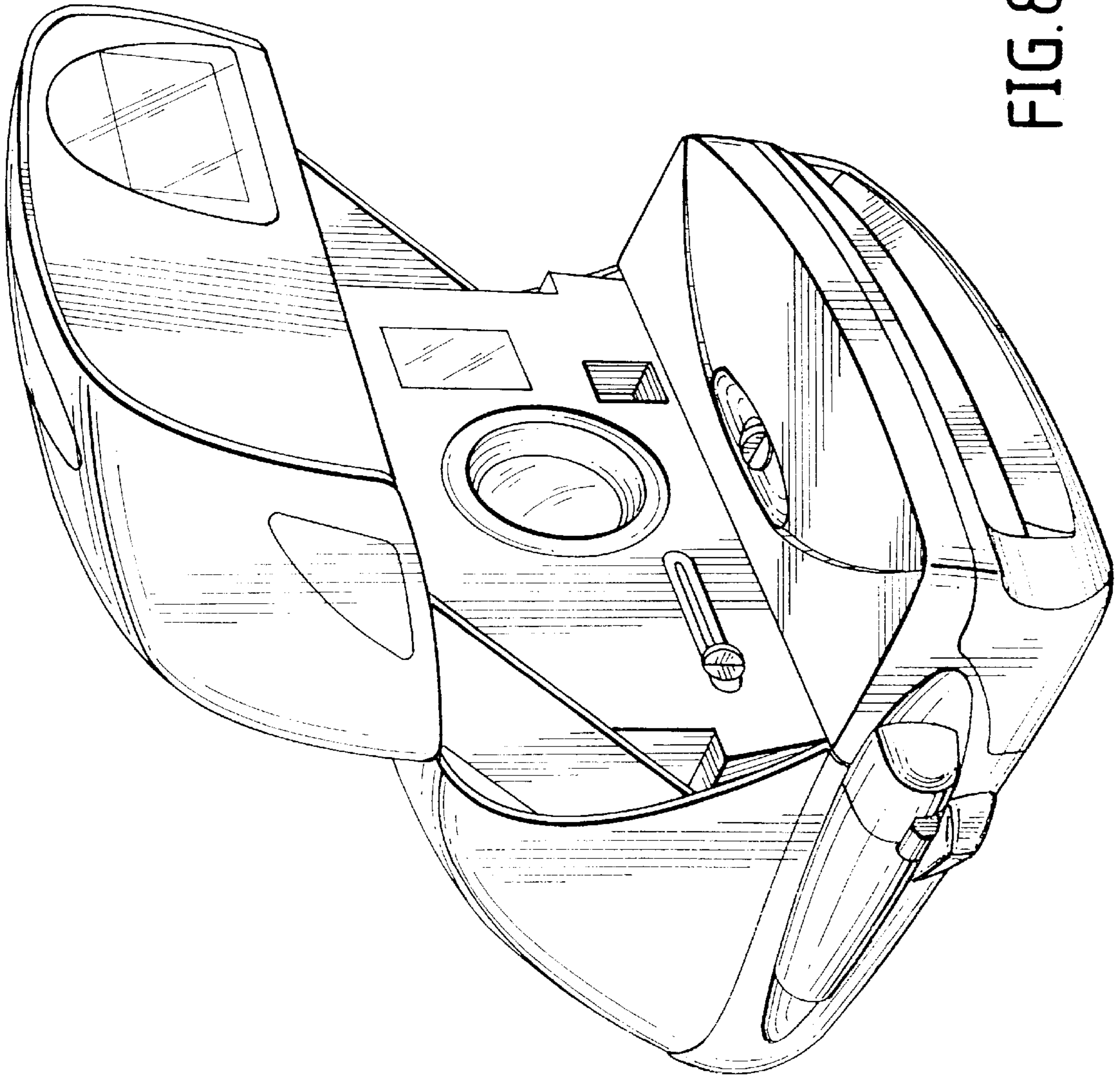

FIG. 8

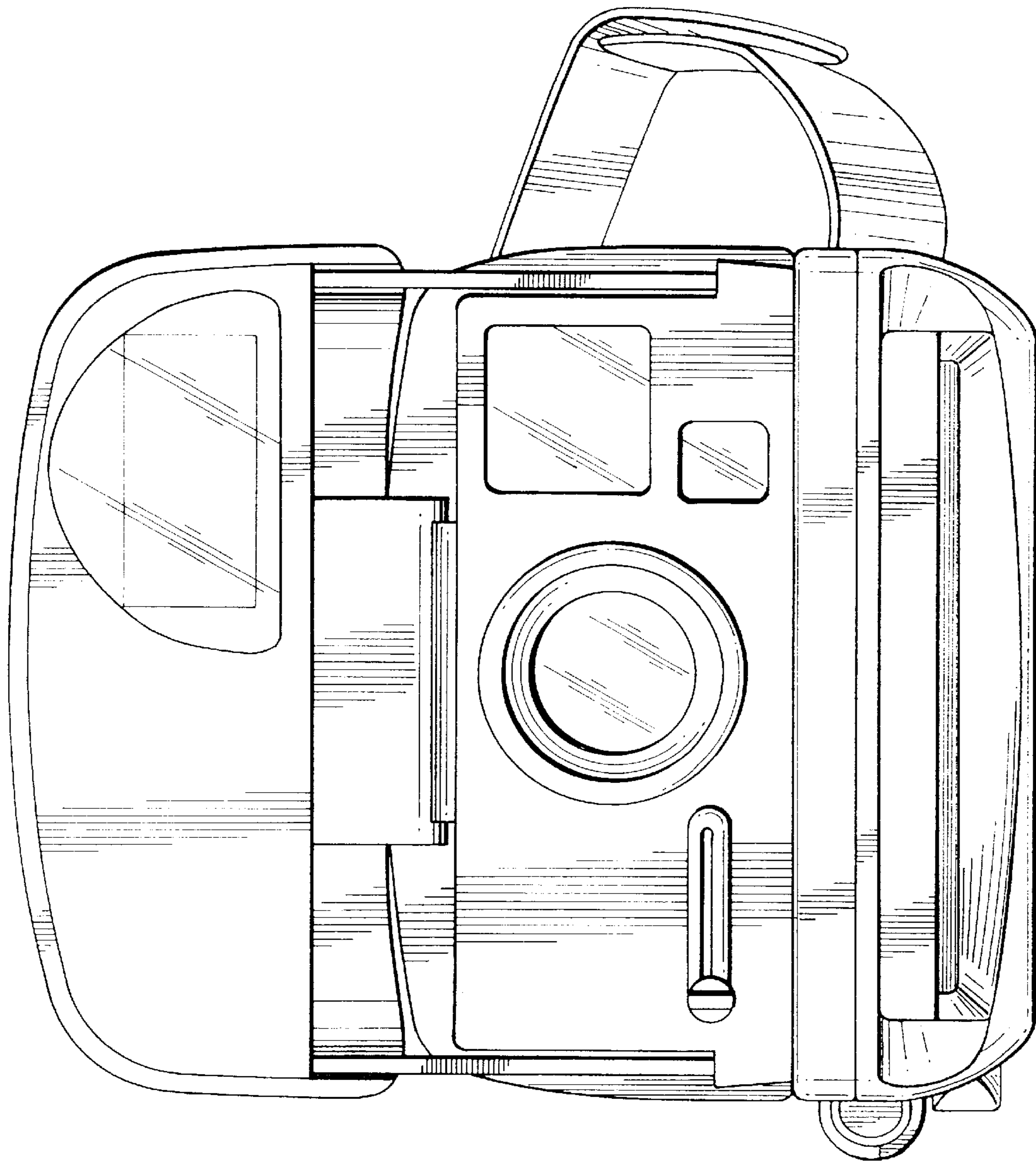

FIG. 9

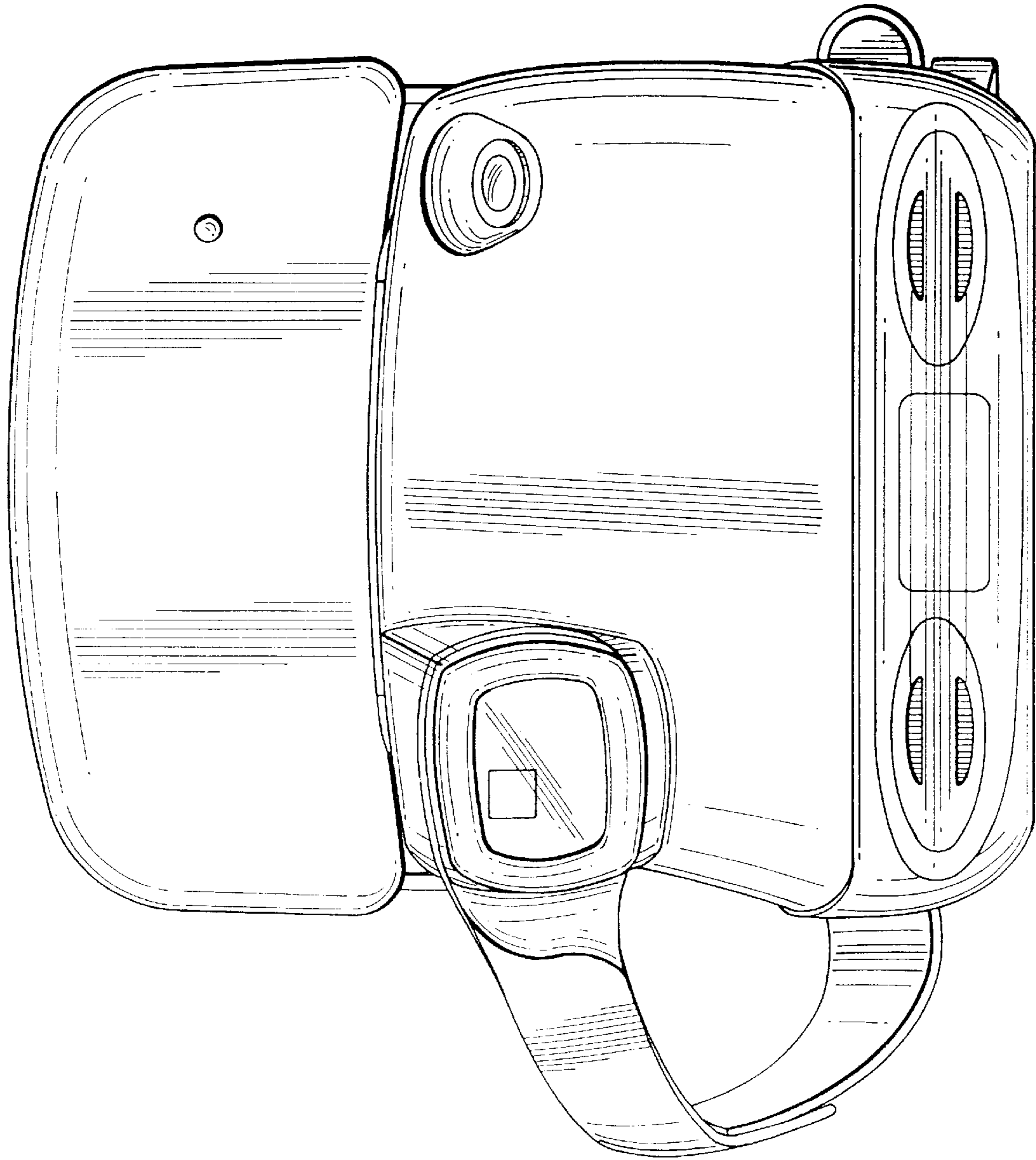

FIG.10

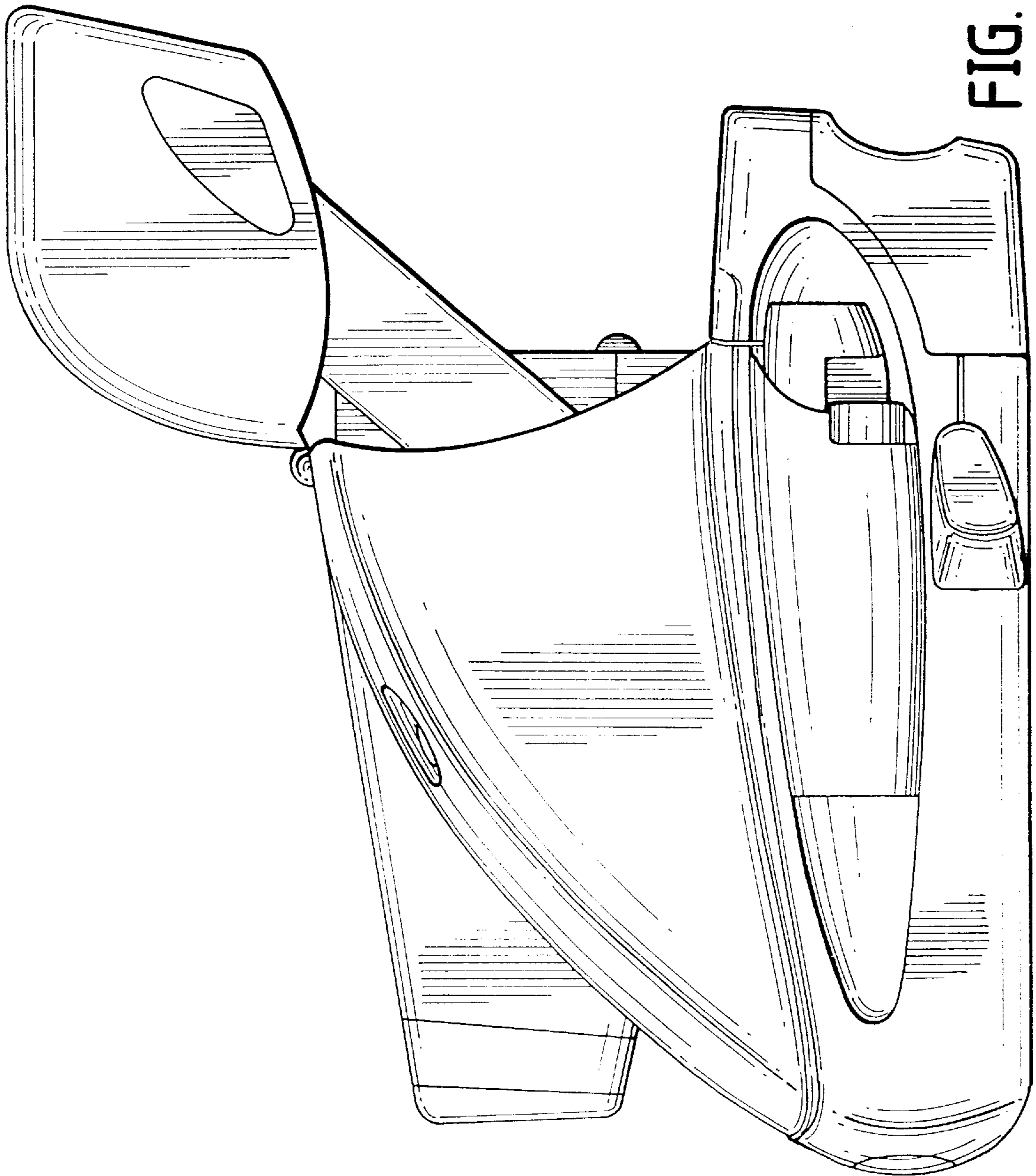

FIG. 11

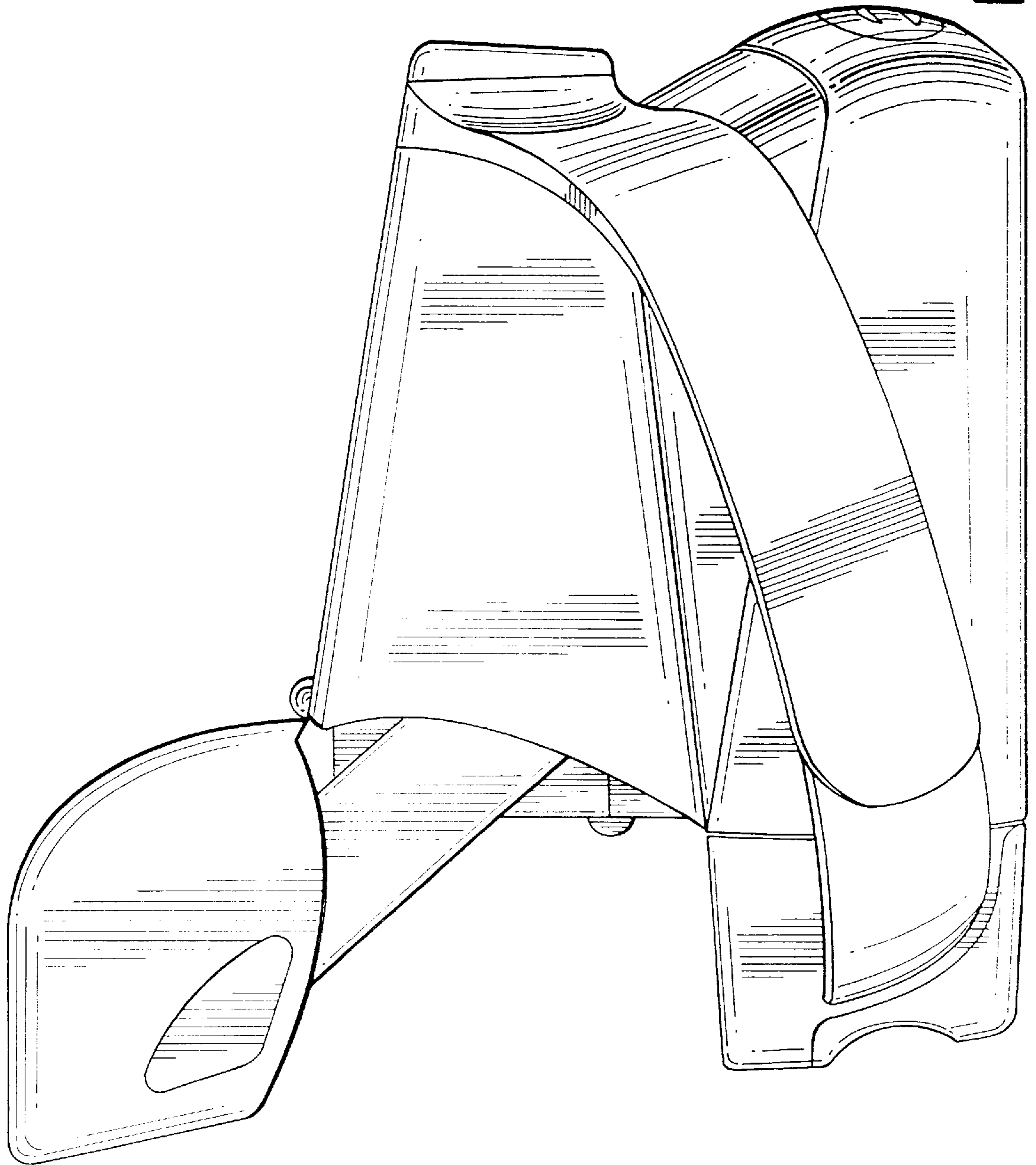

FIG.12

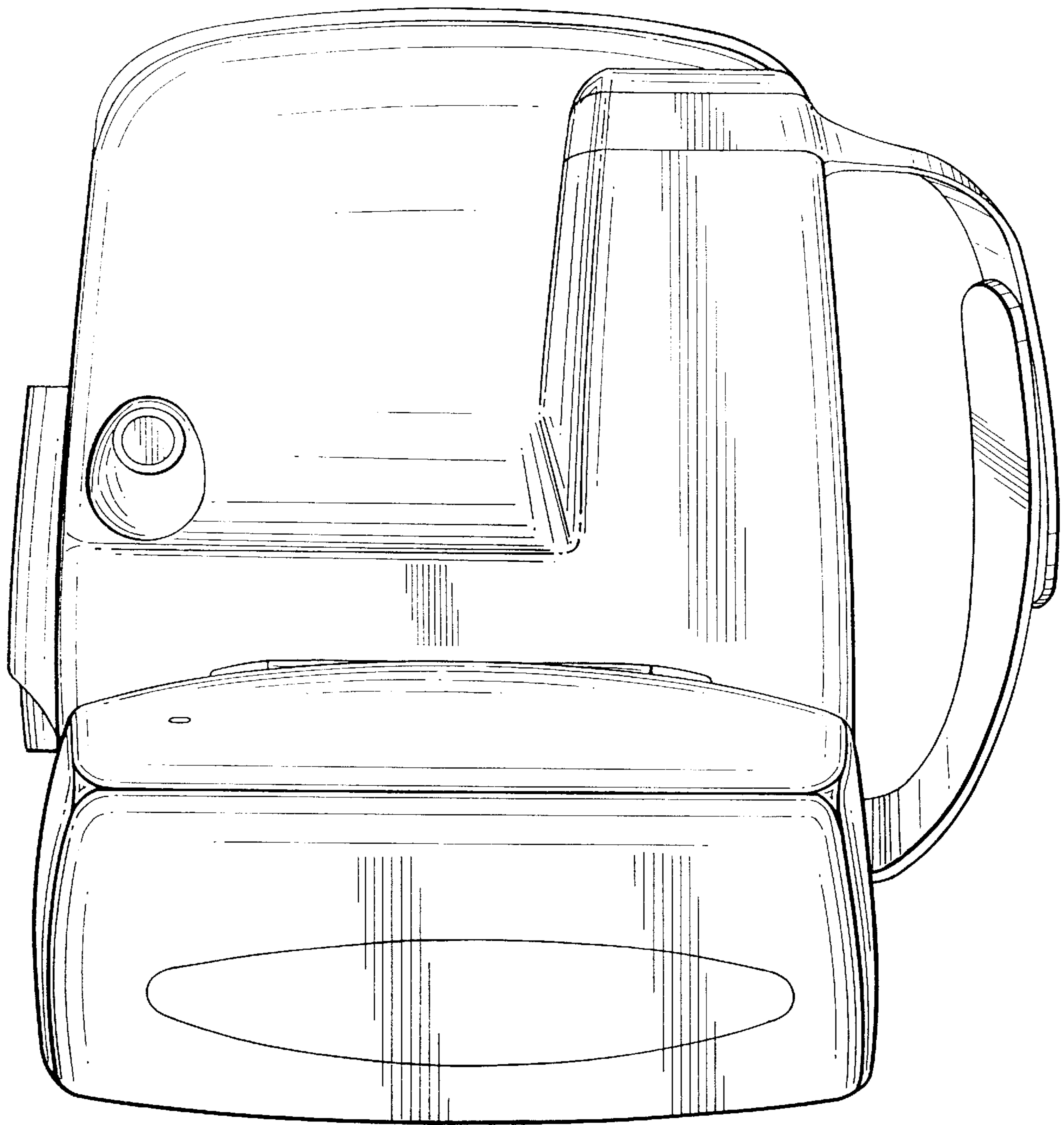

FIG.13