



US00D399498S

# United States Patent [19] Chang

[11] **Patent Number: Des. 399,498**

[45] **Date of Patent: \*\*Oct. 13, 1998**

[54] **REMOVABLE HARD DISK DRIVE HOLDER AND CASSETTE**

*Attorney, Agent, or Firm*—Claude A. S. Hamrick; Oppenheimer W. Donnelly; Chien-Wei (Chris) Chou

[75] Inventor: **Dean Chang**, Taipei, Taiwan

[57] **CLAIM**

[73] Assignee: **Sailing Strong International Co., Ltd.**, Taipei, Taiwan

The ornamental design for a removable hard disk drive holder and cassette, as shown and described.

[\*\*] Term: **14 Years**

### DESCRIPTION

[21] Appl. No.: **74,931**

FIG. 1 is a front right and top perspective view of a removable hard disk drive holder and cassette showing my new design wherein the holder is shown separately for clarity of illustration only;

[22] Filed: **Aug. 13, 1997**

[51] **LOC (6) Cl.** ..... **14-02**

FIG. 2 is a right side elevation view thereof;

[52] **U.S. Cl.** ..... **D14/109; D14/114**

FIG. 3 is a left side elevation view thereof;

[58] **Field of Search** ..... D14/100, 102, D14/107-109; D13/162, 184, 199; 312/292; 360/63, 99.01-99.12; 369/34, 36; 361/728, 730, 732, 736, 740, 685; 379/67, 112

FIG. 4 is a front elevation view thereof;

FIG. 5 is a rear elevation view thereof;

FIG. 6 is a top view thereof;

FIG. 7 is a bottom view thereof;

### [56] **References Cited**

FIG. 8 is a front right and top perspective view of the removable hard disk drive holder with a cassette shown partially extended from the holder;

#### U.S. PATENT DOCUMENTS

|            |         |                 |       |           |
|------------|---------|-----------------|-------|-----------|
| D. 308,052 | 5/1990  | Darden et al.   | ..... | D14/109   |
| D. 311,737 | 10/1990 | Westwood et al. | ..... | D14/114   |
| D. 322,604 | 12/1991 | Komatsu         | ..... | D14/114   |
| 3,789,161  | 1/1974  | Mizumoto        | ..... | 360/63    |
| 4,754,397  | 6/1988  | Varaiya et al.  | ..... | 361/685   |
| 4,941,841  | 7/1990  | Darden et al.   | ..... | D14/114 X |
| 5,363,273  | 11/1994 | MA              | ..... | D14/109 X |

FIG. 9 is a front right and top perspective view of the cassette thereof shown on an enlarged scale and shown separately for clarity of illustration only;

FIG. 10 is a right side elevation view thereof;

FIG. 11 is a left side elevation view thereof;

FIG. 12 is a front elevation view thereof;

FIG. 13 is a rear elevation view thereof;

FIG. 14 is a top view thereof; and,

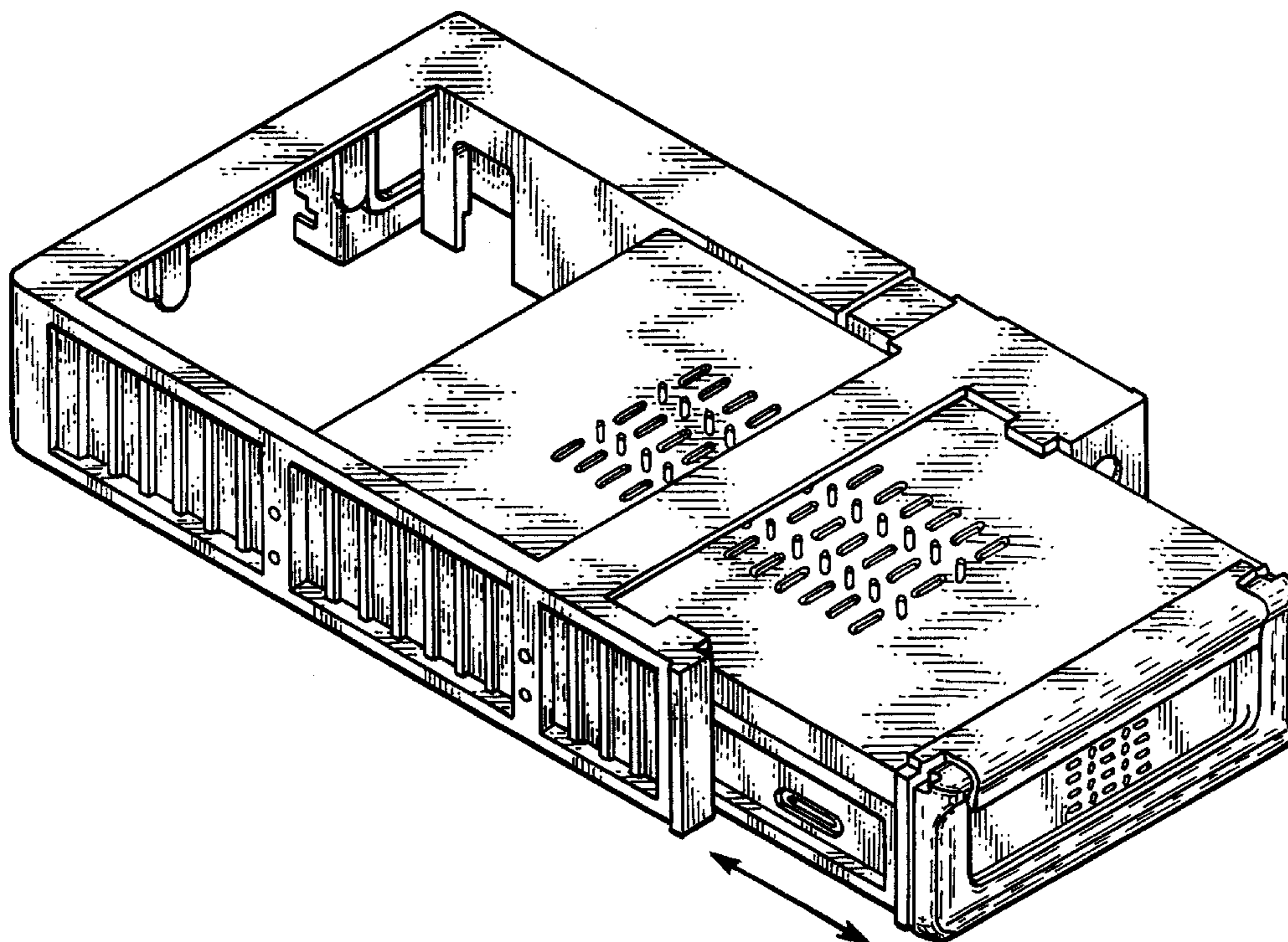
FIG. 15 is a bottom view thereof.

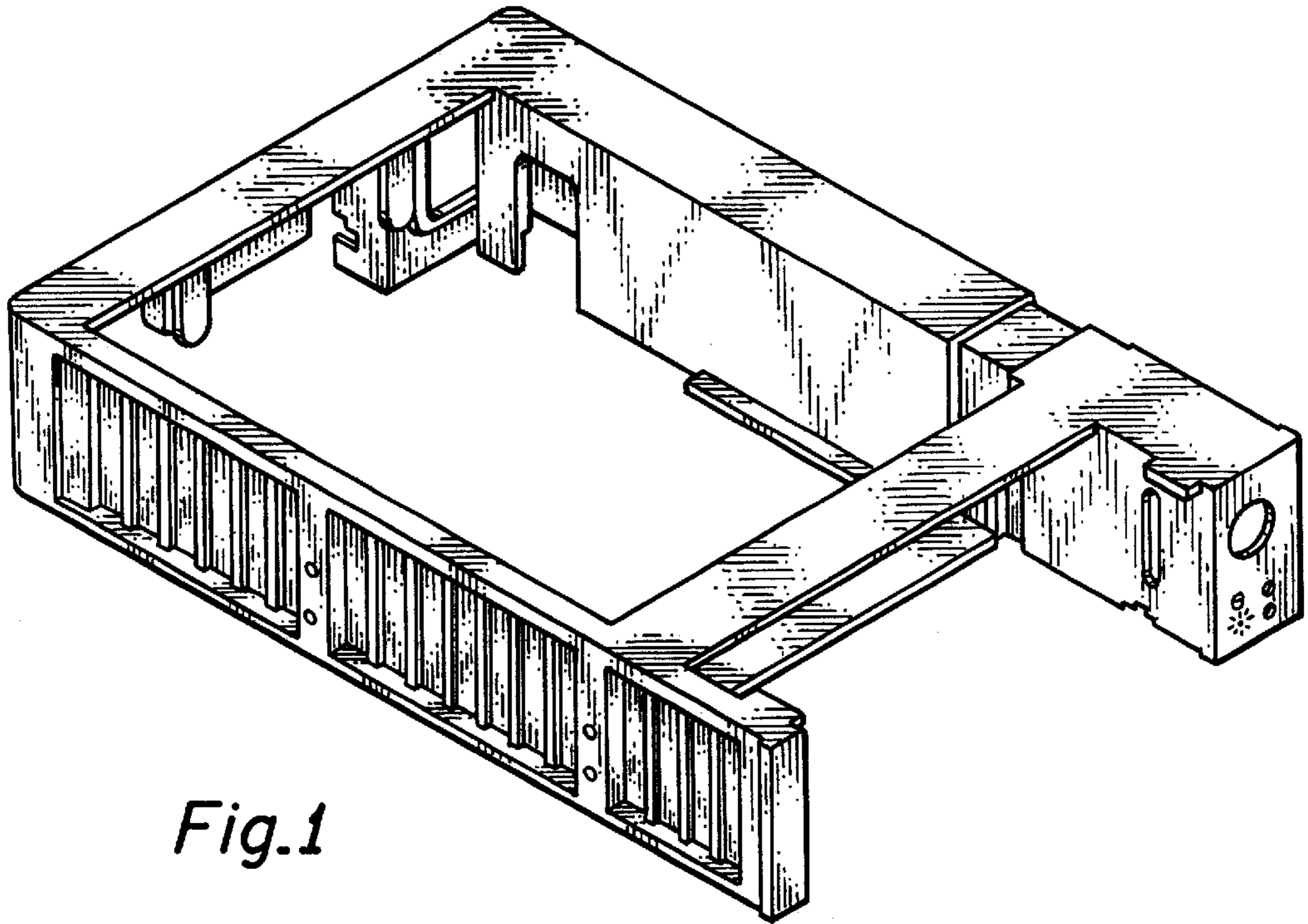
#### OTHER PUBLICATIONS

P.C. Week—Buyers Guide—Jan. 15, 1985, Hard Disk Storage Kamerman Labs.

*Primary Examiner*—Freda Nunn

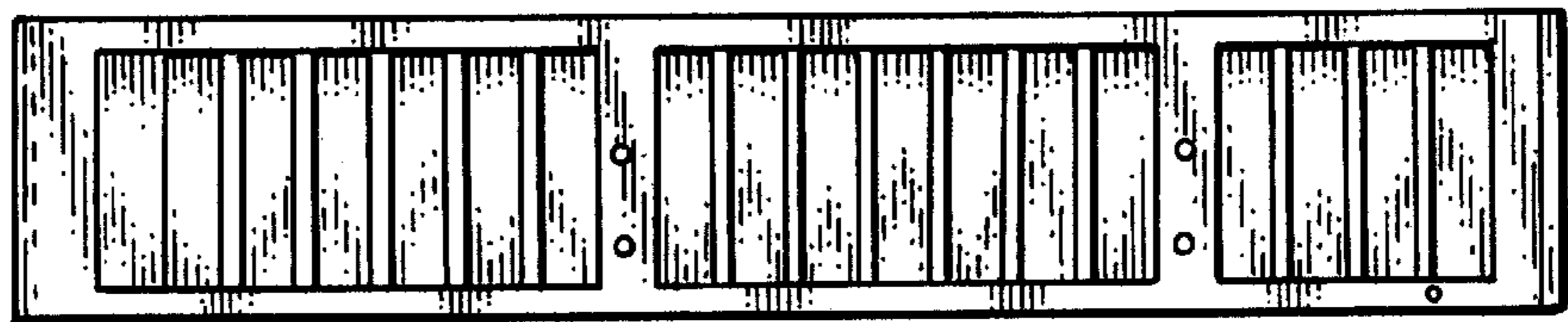
**1 Claim, 4 Drawing Sheets**



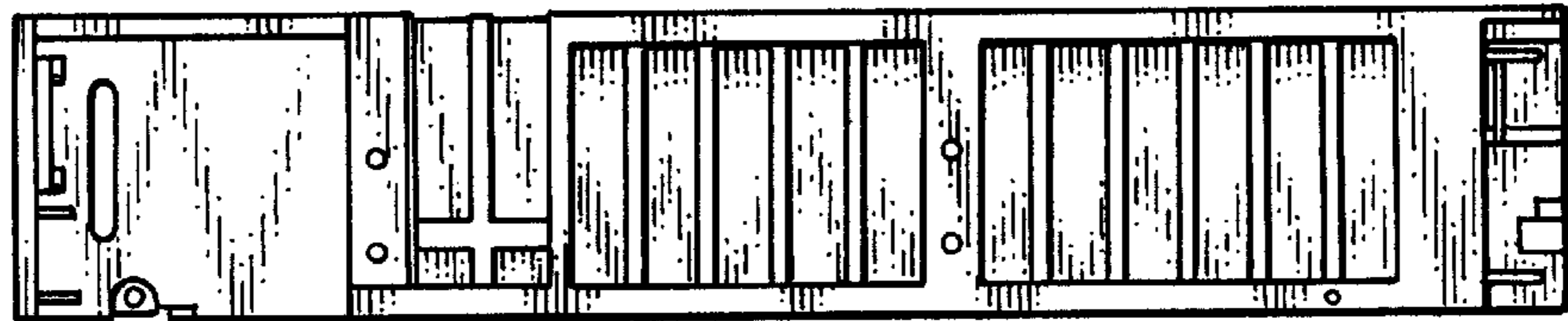


*Fig.1*

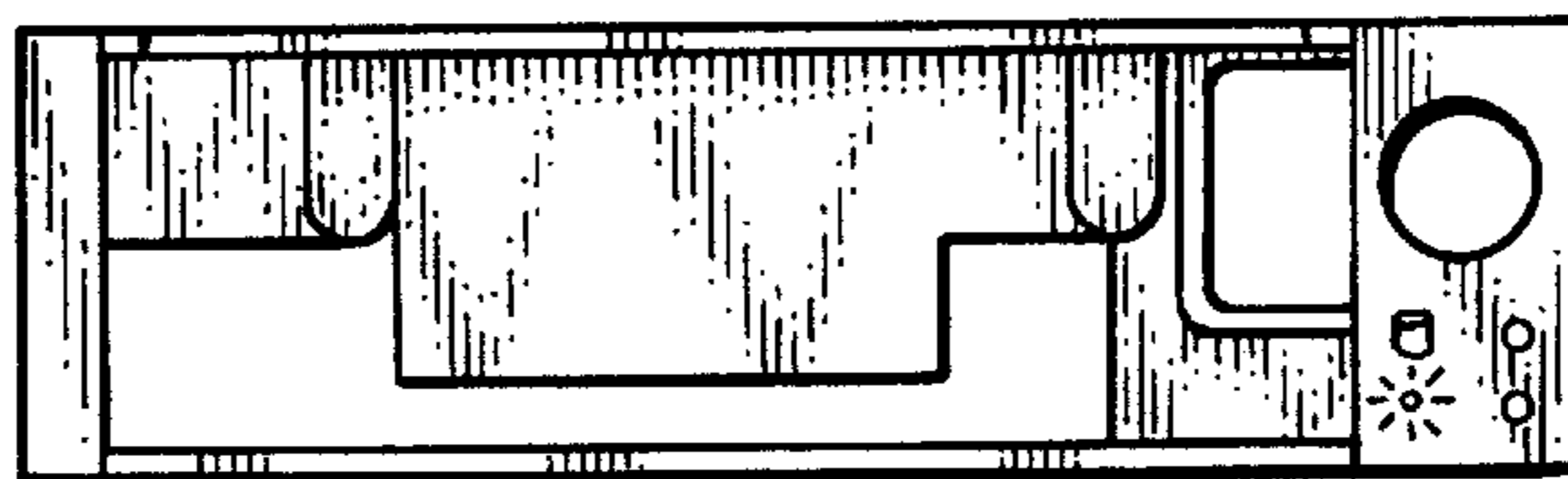
*Fig.2*



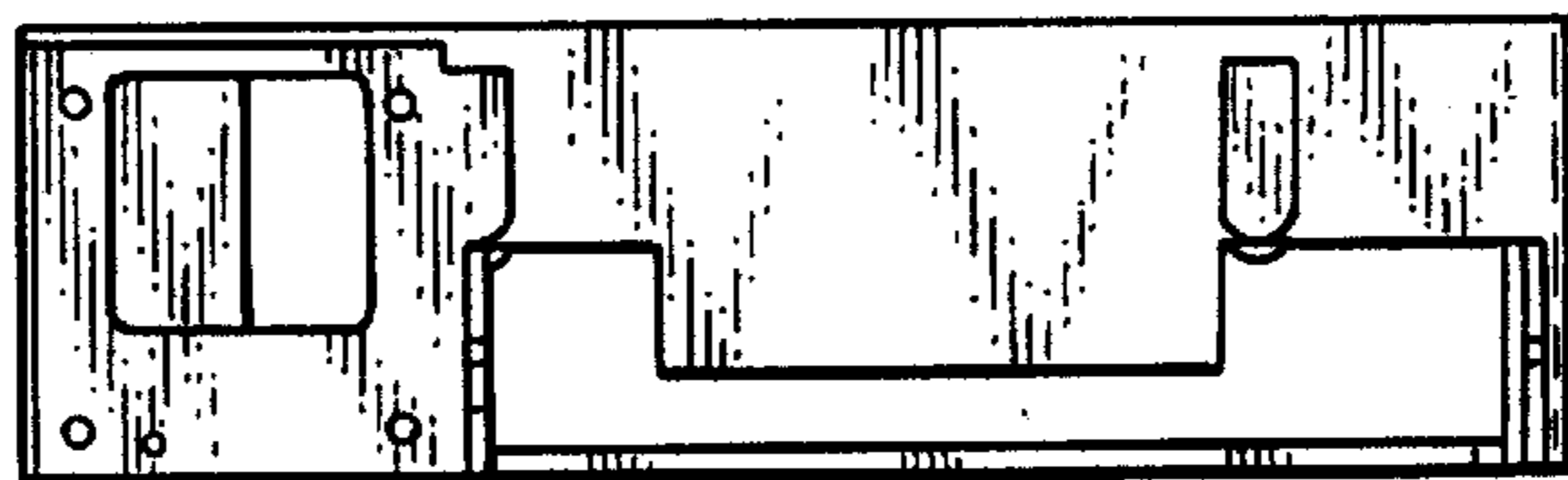
*Fig.3*

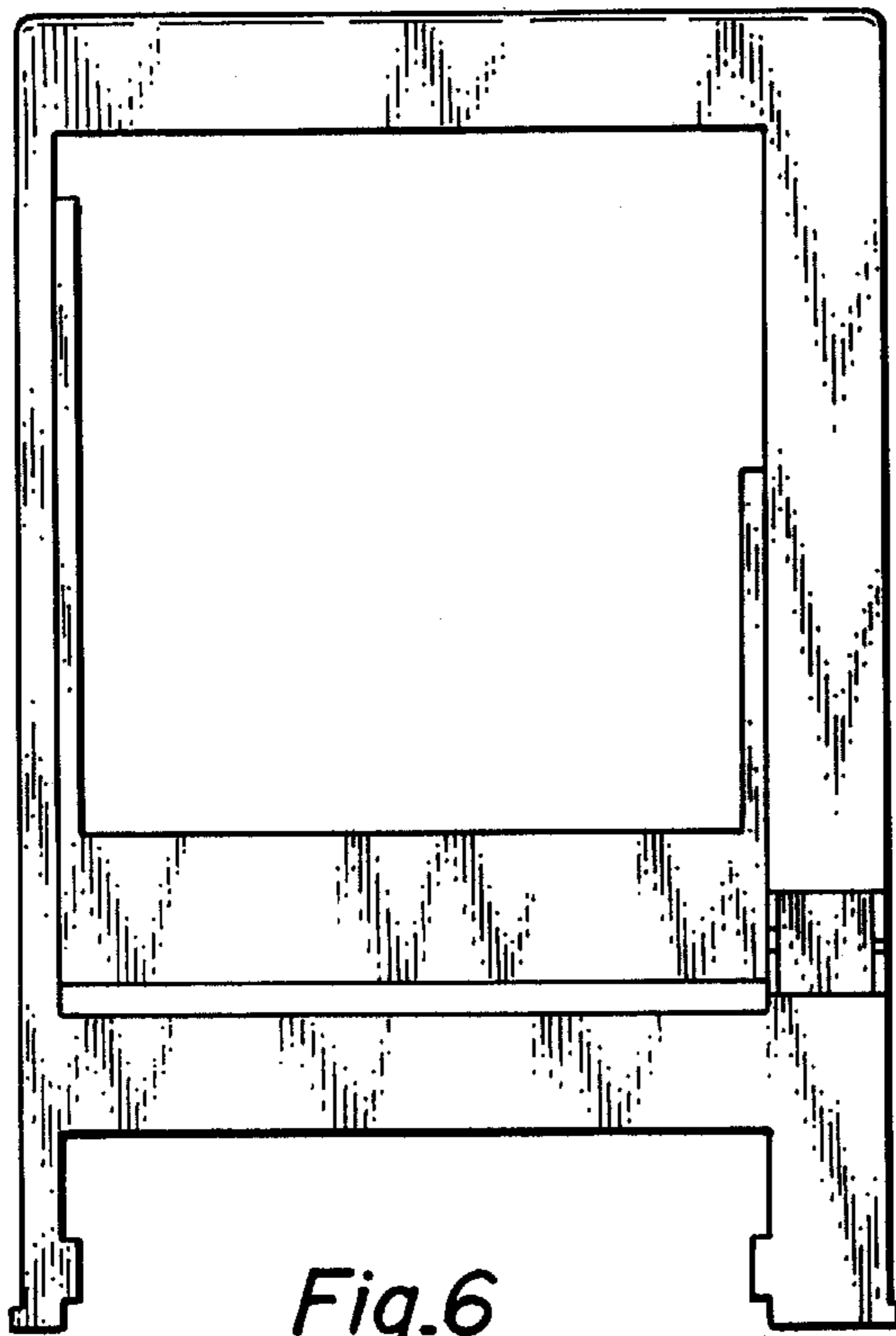


*Fig.4*

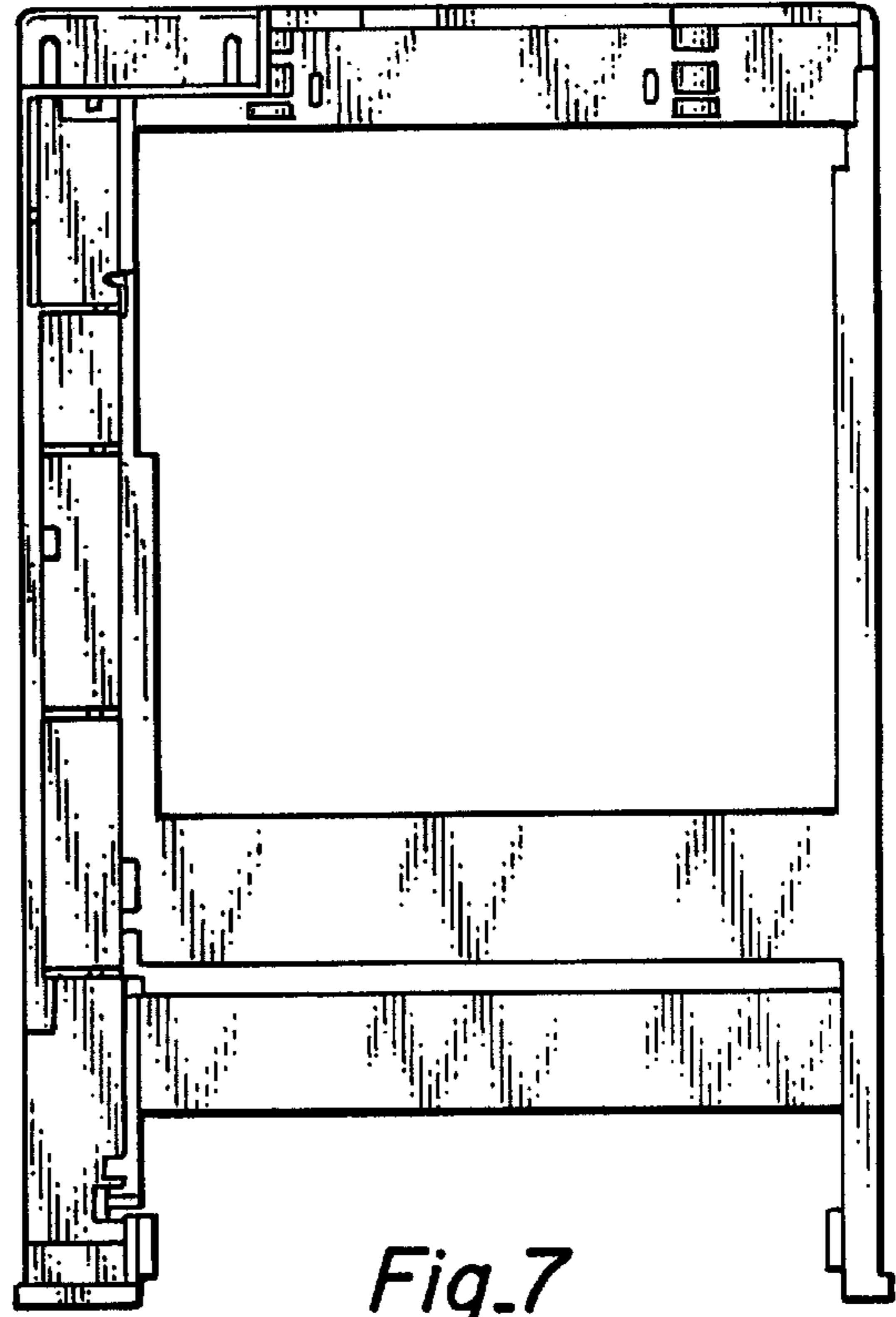


*Fig.5*

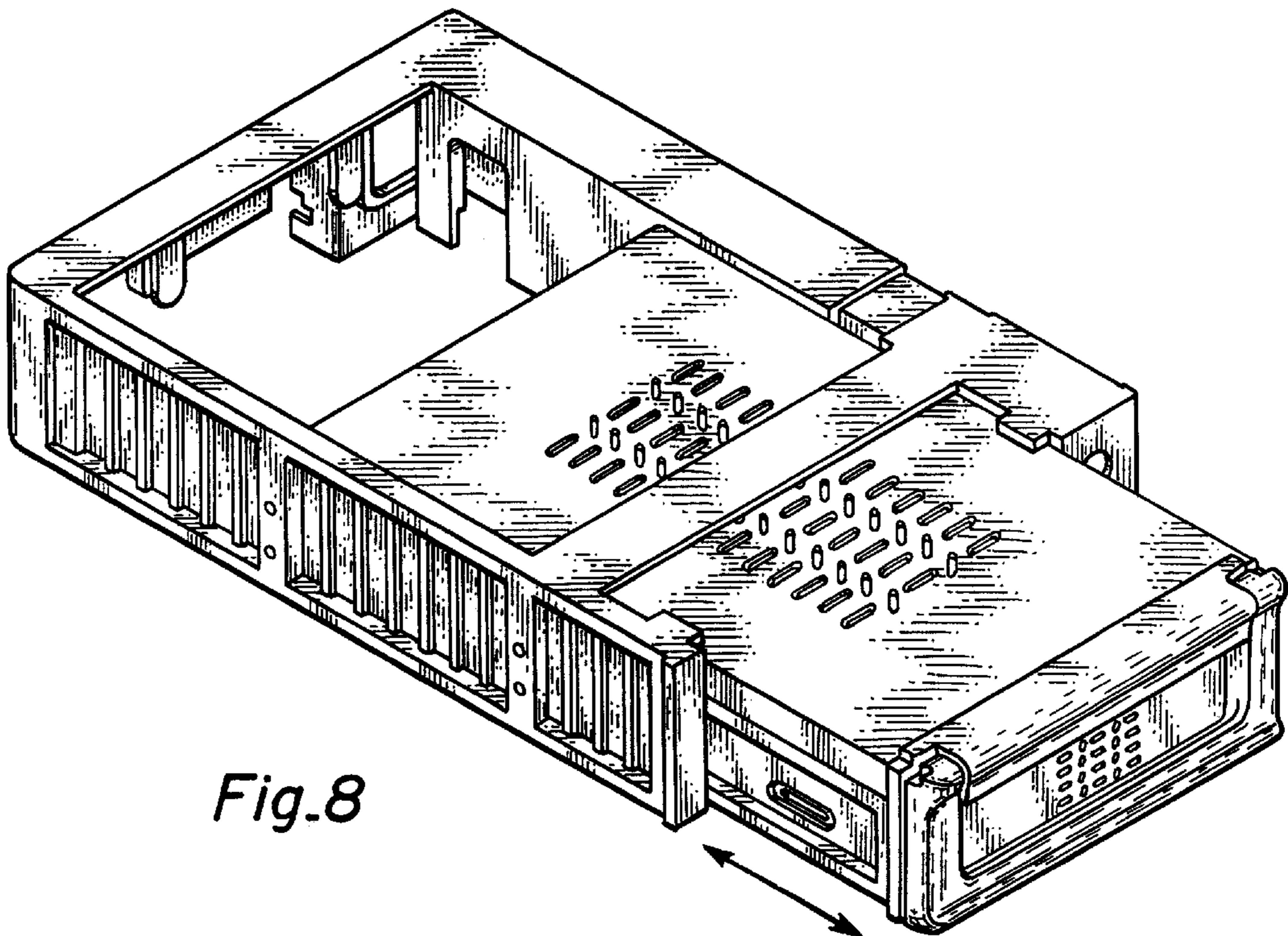




*Fig. 6*



*Fig. 7*



*Fig. 8*

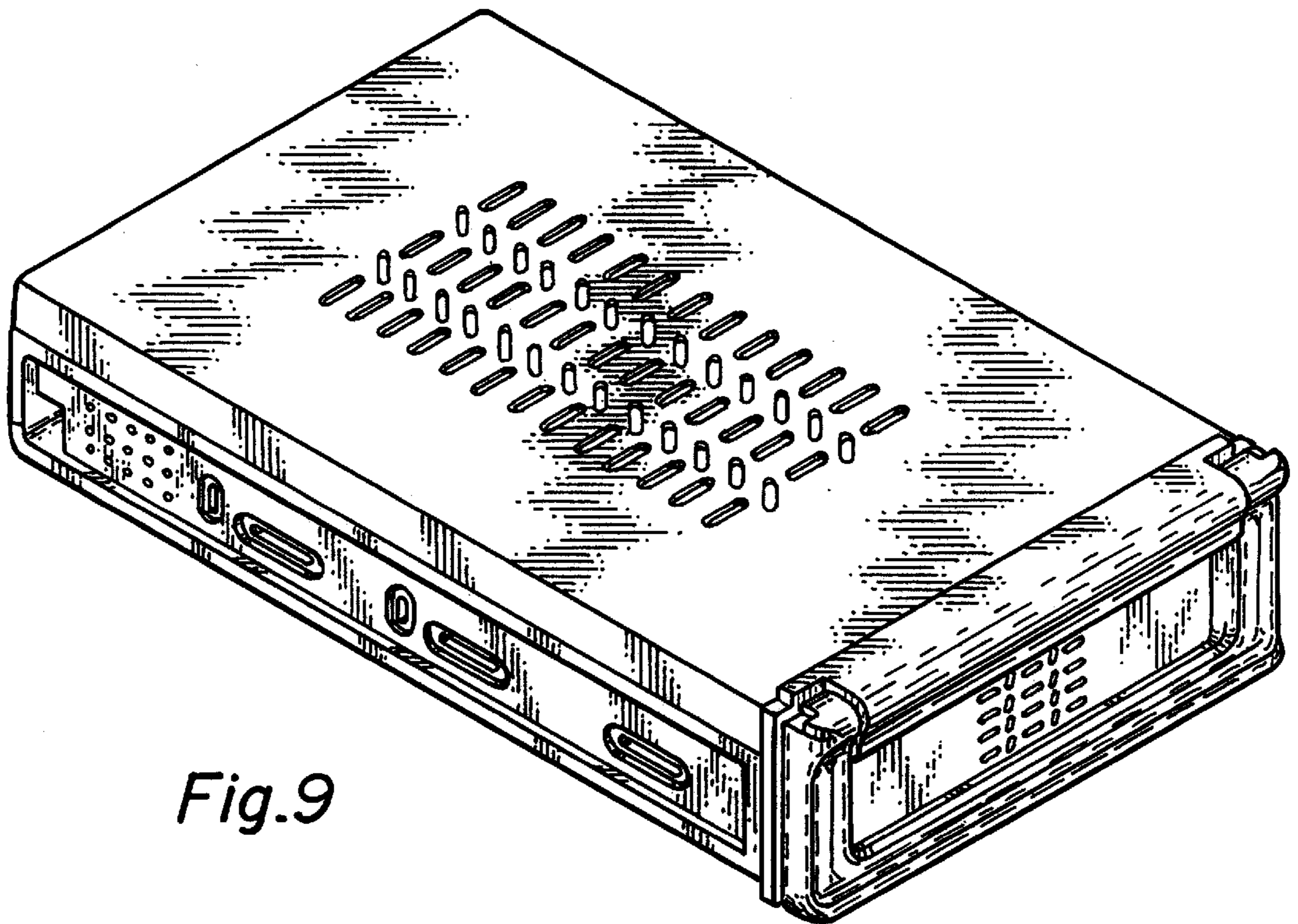


Fig.9

Fig.10

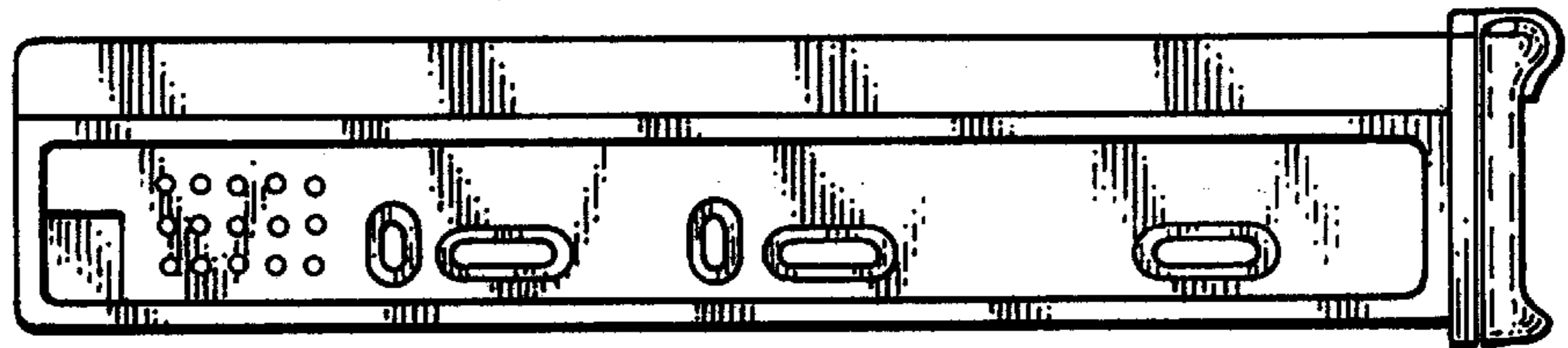


Fig.11

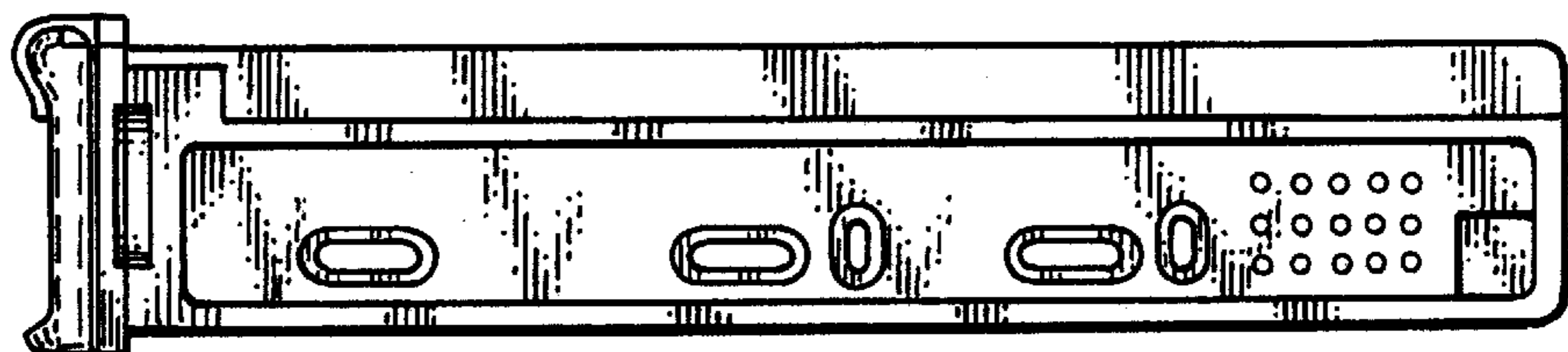


Fig.12

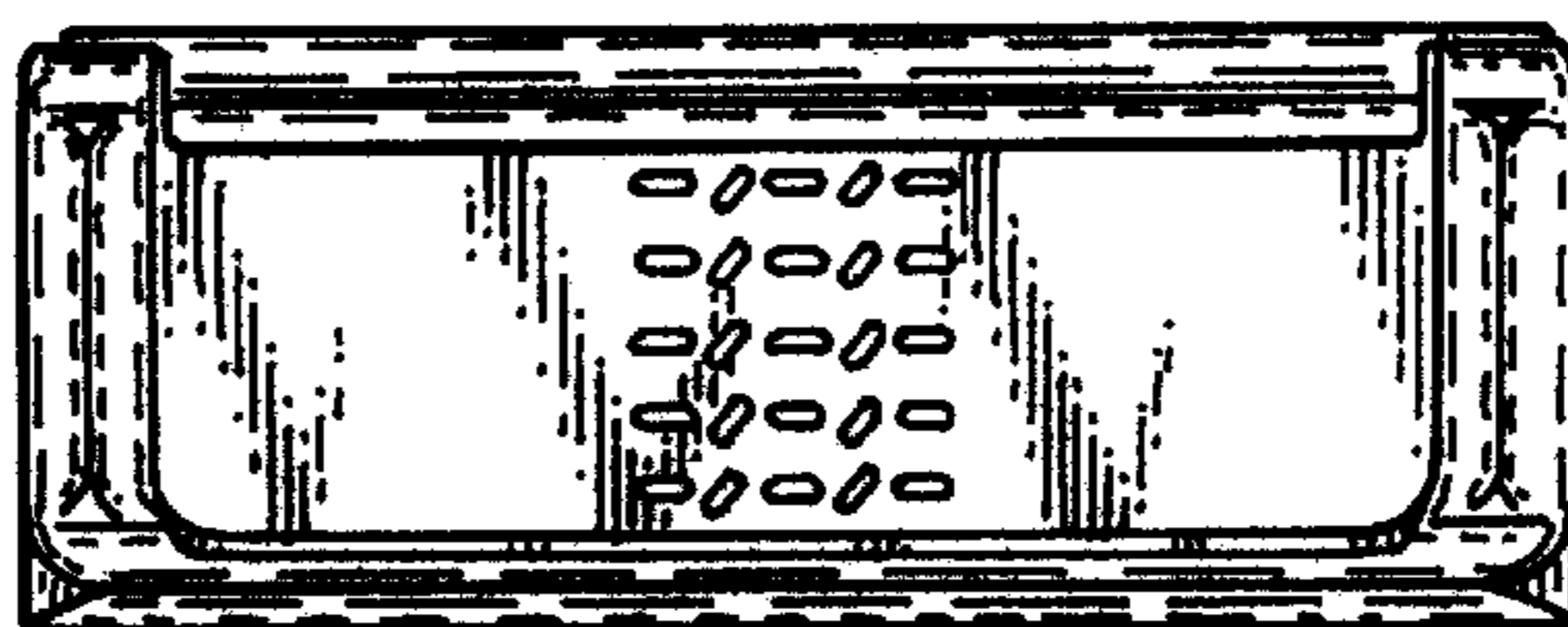


Fig.13



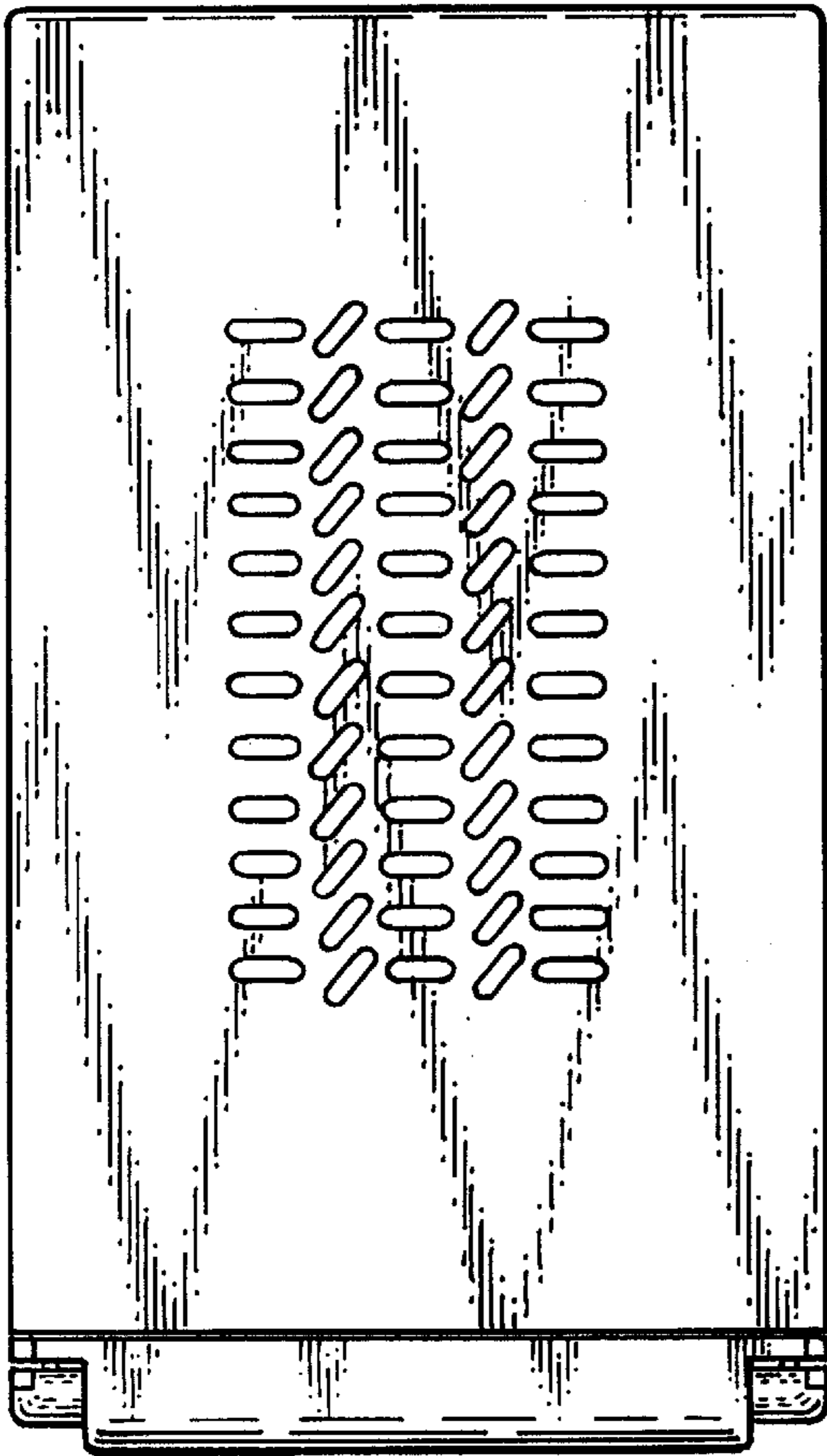


Fig.14

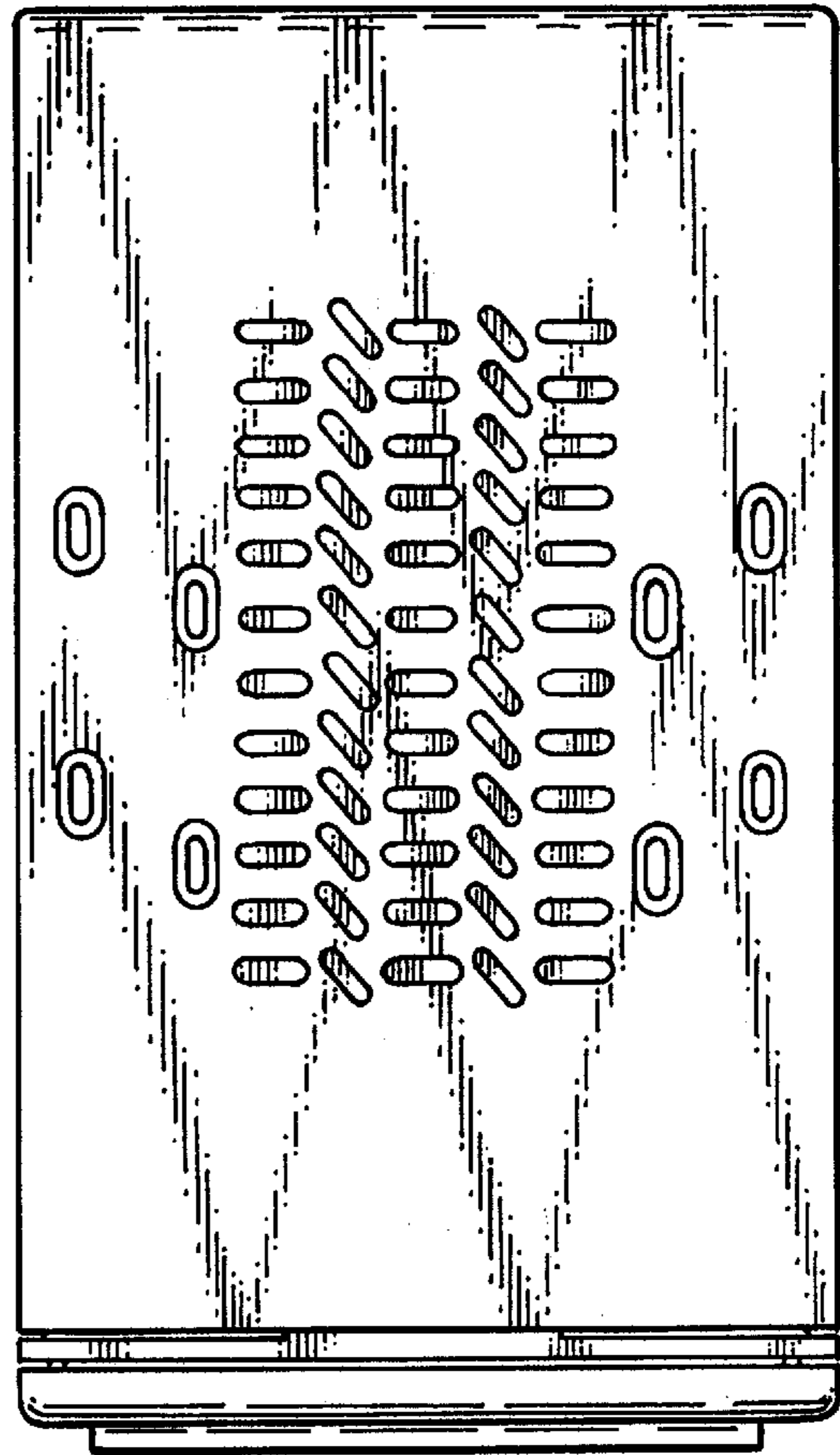


Fig.15