



US00D399458S

United States Patent [19]

Ziegler et al.

[11] Patent Number: Des. 399,458

[45] Date of Patent: **Oct. 13, 1998

[54] **COLLAPSIBLE THREE WHEELED STROLLER**

[76] Inventors: **Scott W. Ziegler**, 932 Vista del Monte Way, El Cajon, Calif. 92020; **Randolph L. Kiser**, 789 Johnston Dr., Sidney, Ohio 45365; **David J. Stroud**, 360 Mapletrace Trail, Dayton, Ohio 45458; **Cheri Wagner**, 9625 Greenville Falls Rd., Covington, Ohio 45318

[**] Term: **14 Years**

[21] Appl. No.: **61,500**

[22] Filed: **Oct. 25, 1996**

[51] LOC (6) Cl. **12-12**

[52] U.S. Cl. **D12/129; D12/128**

[58] Field of Search D12/128, 129, D12/133; 280/650, 648, 647, 643, 642, 644, 30

[56] **References Cited**

U.S. PATENT DOCUMENTS

5,364,119 11/1994 Leu 280/650
5,590,896 1/1997 Eichhorn 280/642

Primary Examiner—Kay H. Chin

[57] **CLAIM**

The ornamental design of the collapsible three wheeled stroller, as shown and described.

DESCRIPTION

FIG. 1 is a perspective view of the collapsible three wheeled stroller showing the design of our invention; FIG. 2 is a right side view thereof; FIG. 3 is a front view thereof; FIG. 4 is a rear view thereof; FIG. 5 is a top plan view thereof; and, FIG. 6 is a bottom view thereof.

The left side view is a mirror image of the right side view.

1 Claim, 4 Drawing Sheets

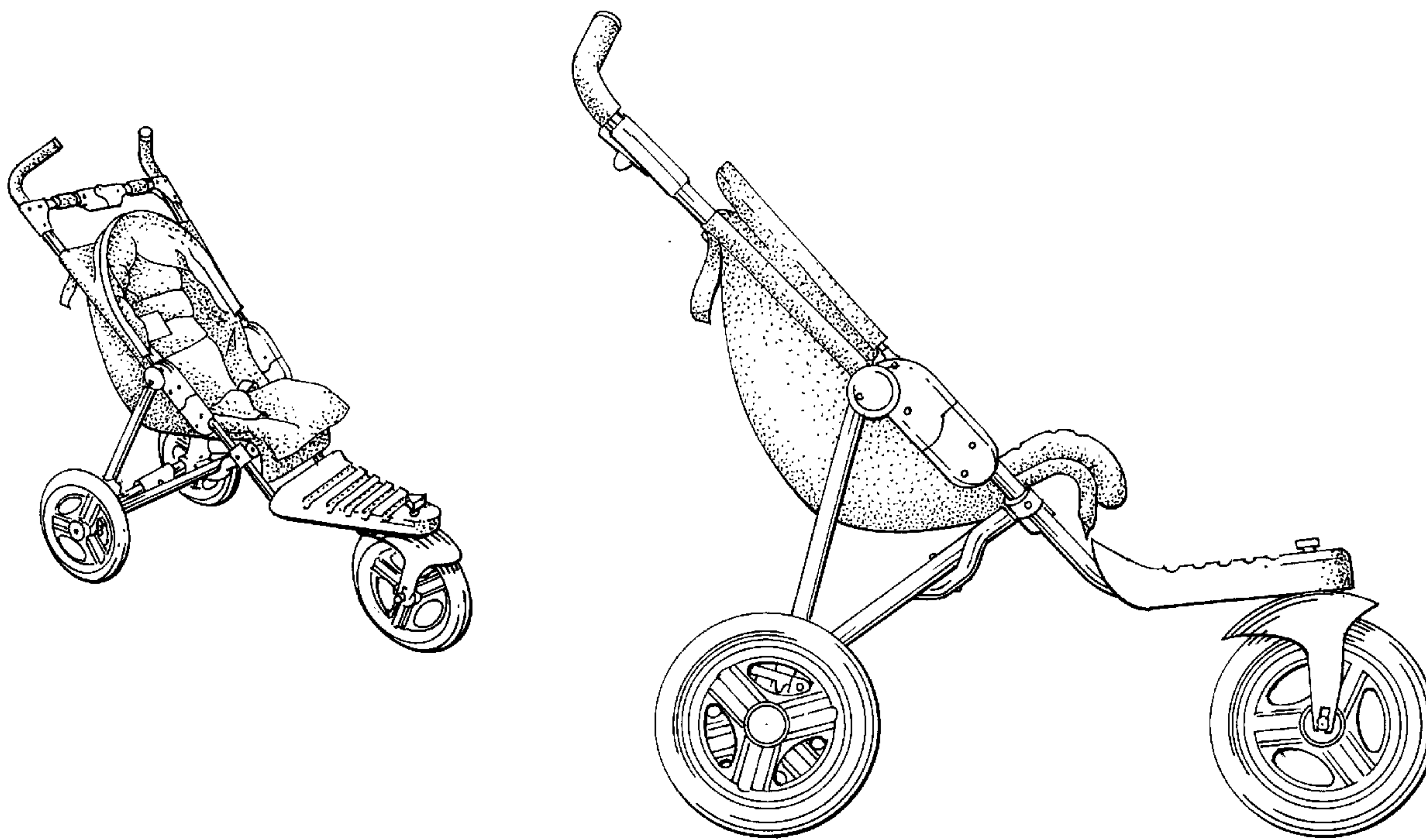

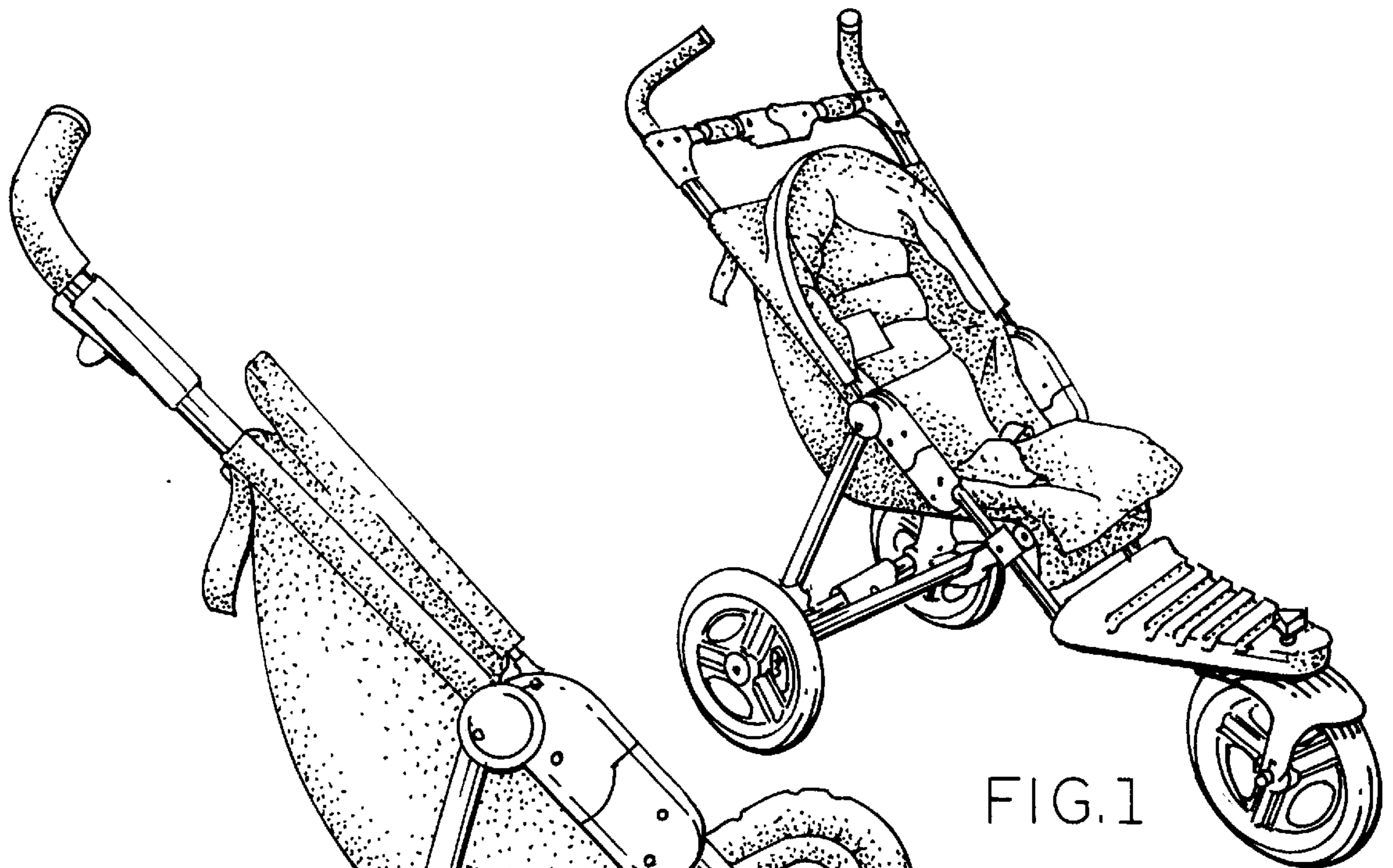

FIG. 1

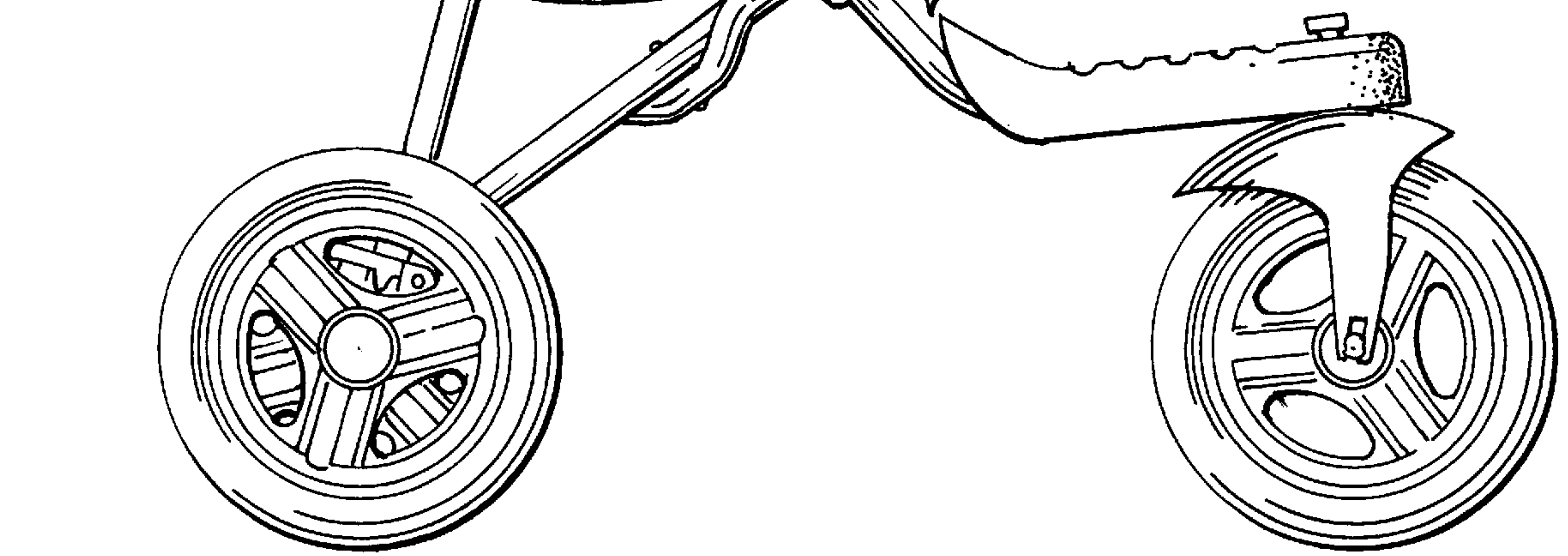

FIG. 2

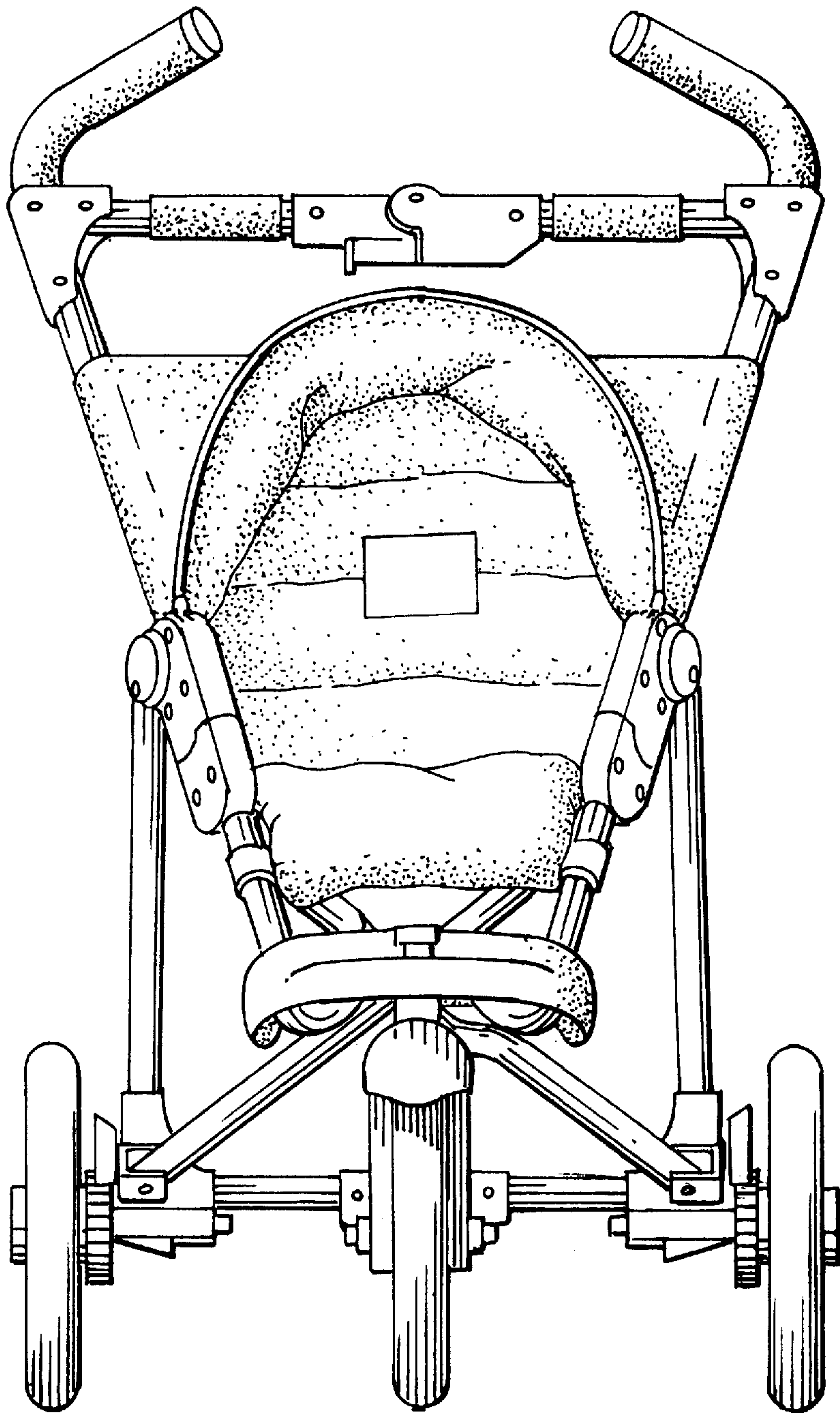

FIG. 3

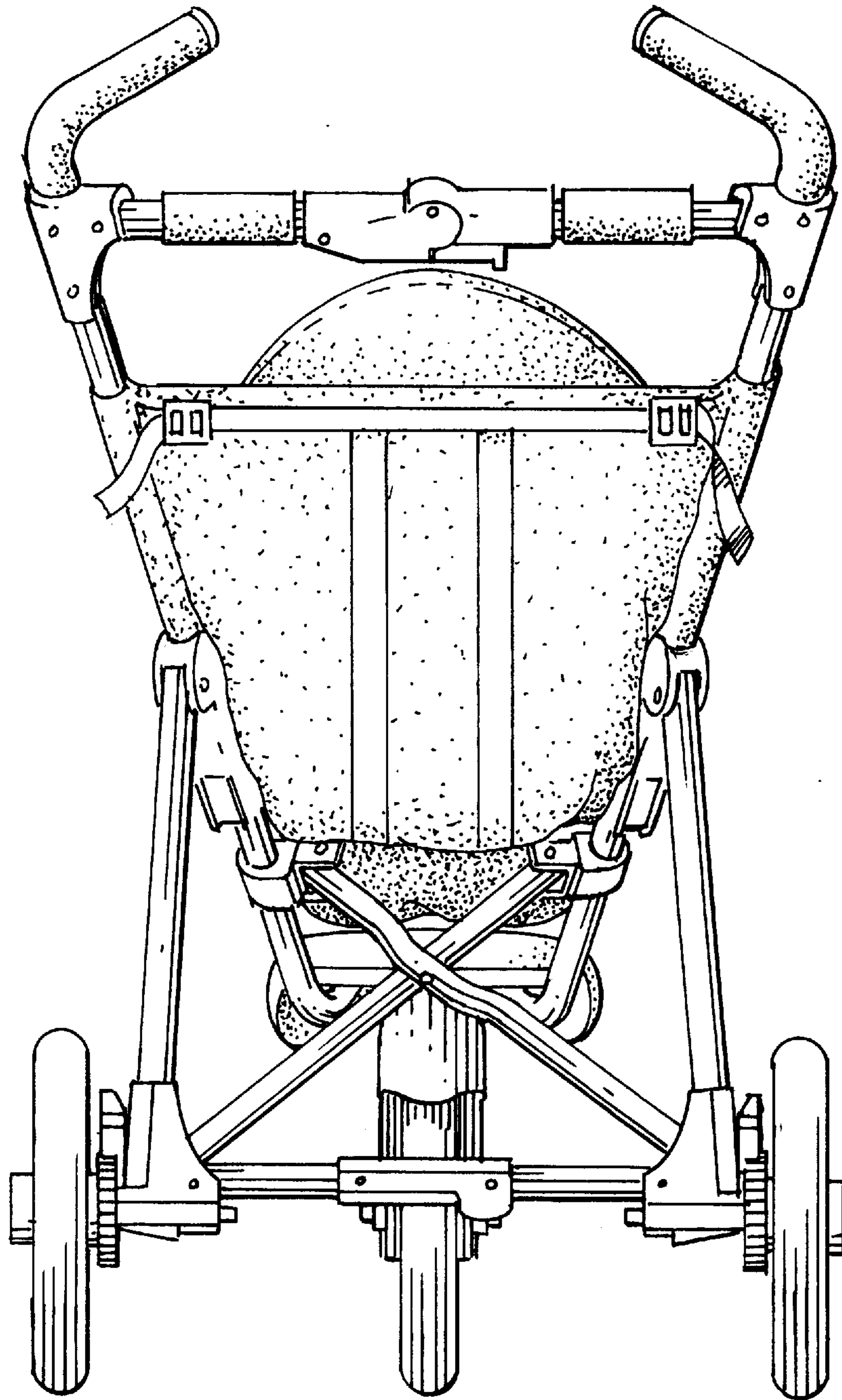

FIG. 4

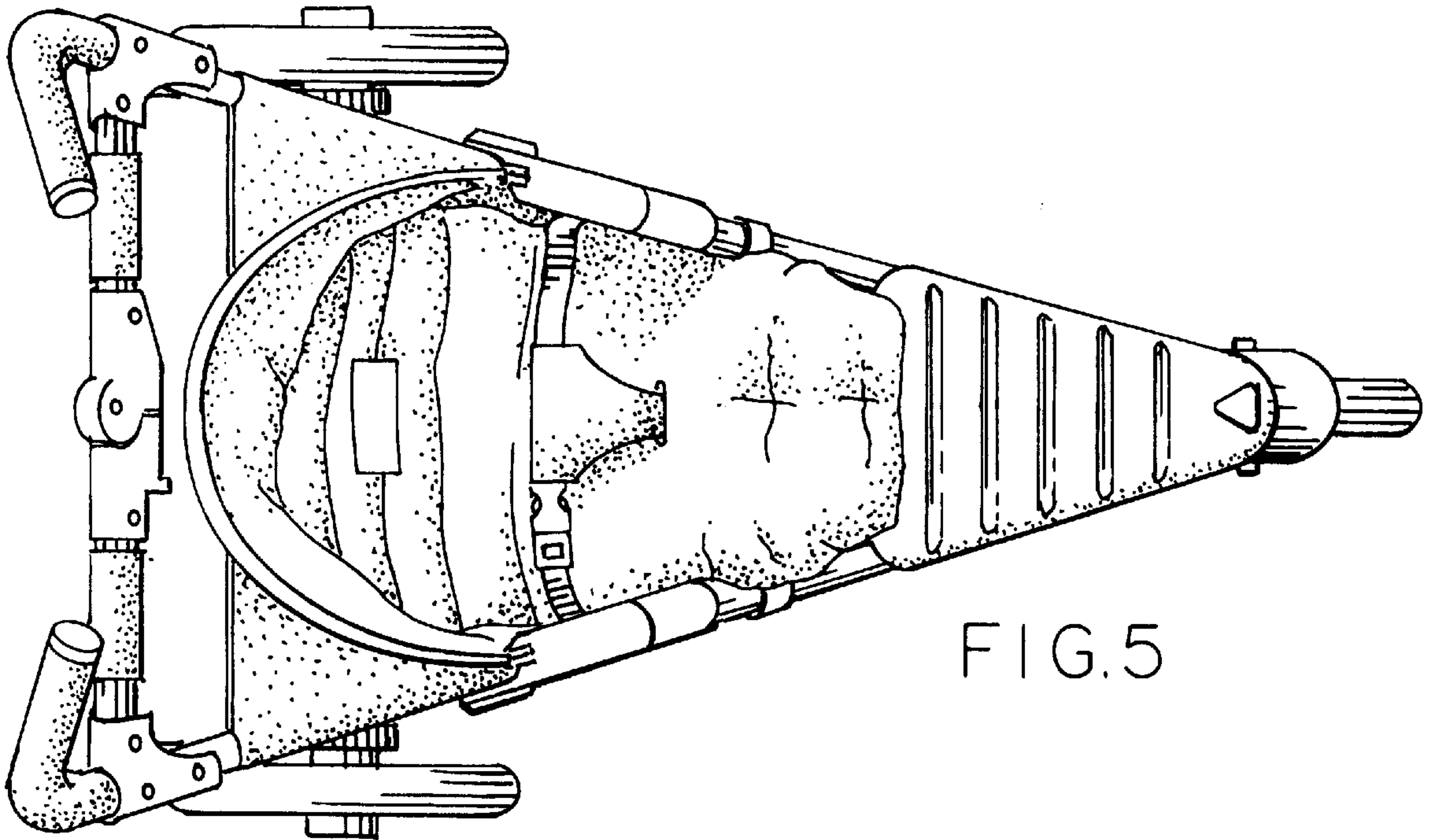

FIG. 5

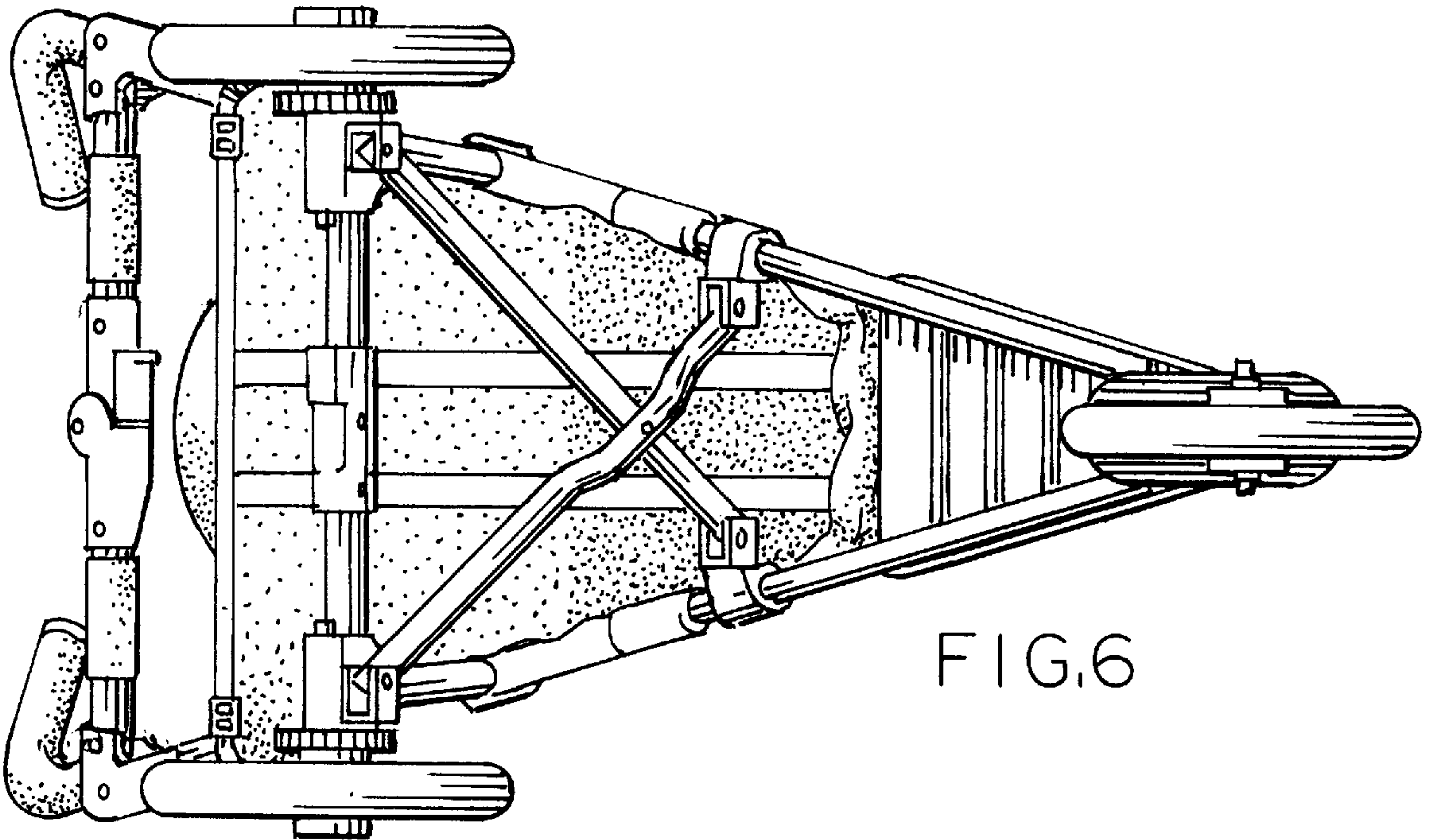

FIG. 6