



US00D399440S

United States Patent [19] Taylor

[11] **Patent Number: Des. 399,440**

[45] **Date of Patent: **Oct. 13, 1998**

[54] **BEND RULE**

[75] Inventor: **Christopher L. Taylor**, Dallas, Tex.

[73] Assignee: **Taylor Design Group, Inc.**, Carrollton, Tex.

[**] Term: **14 Years**

[21] Appl. No.: **75,352**

[22] Filed: **Jun. 23, 1997**

Related U.S. Application Data

[63] Continuation of Ser. No. 705,722, Aug. 30, 1996, abandoned.

[51] **LOC (6) Cl.** **10-04**

[52] **U.S. Cl.** **D10/71**

[58] **Field of Search** D10/71; 33/483-484

[56] References Cited

U.S. PATENT DOCUMENTS

D. 238,668 2/1976 Michand D10/71

D. 335,089 4/1993 Grubelnik D10/64
D. 345,511 3/1994 Petrohilos D10/64

Primary Examiner—Antoine Duval Davis
Attorney, Agent, or Firm—Workman, Nydegger & Seeley

[57] CLAIM

The ornamental design for a bend rule, as shown and described.

DESCRIPTION

FIG. 1 is a perspective view of a bend rule showing the design;
FIG. 2 is an alternative perspective view of the bend rule shown in FIG. 1;
FIG. 3 is a top plan view thereof;
FIG. 4 is a front elevational view thereof;
FIG. 5 is a bottom plan view thereof;
FIG. 6 is a back elevational view thereof; and,
FIG. 7 is an end elevational view thereof, the other end being identical.

The broken line showing is for illustrative purposes only and forms no part of the claimed design.

1 Claim, 2 Drawing Sheets

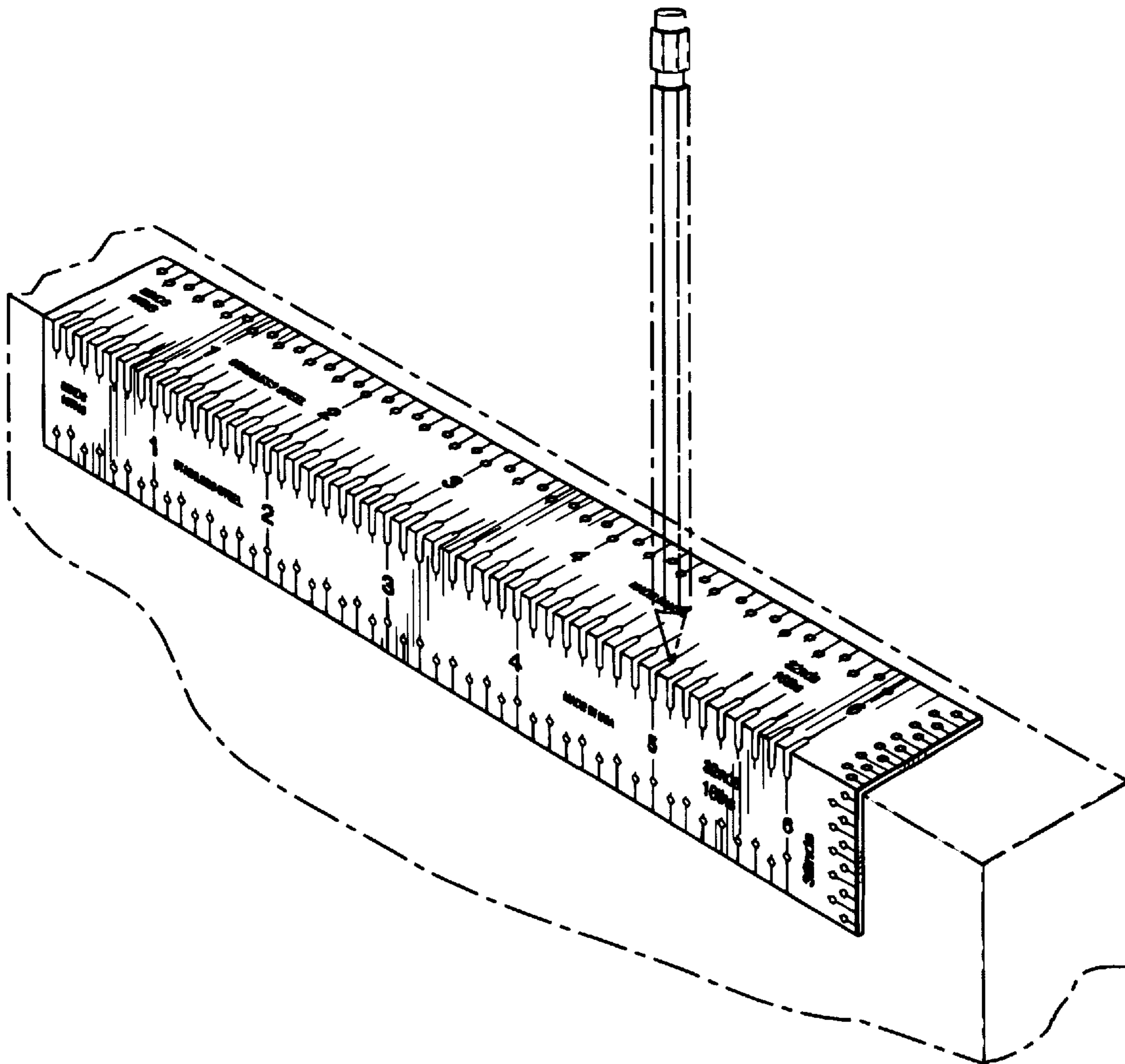

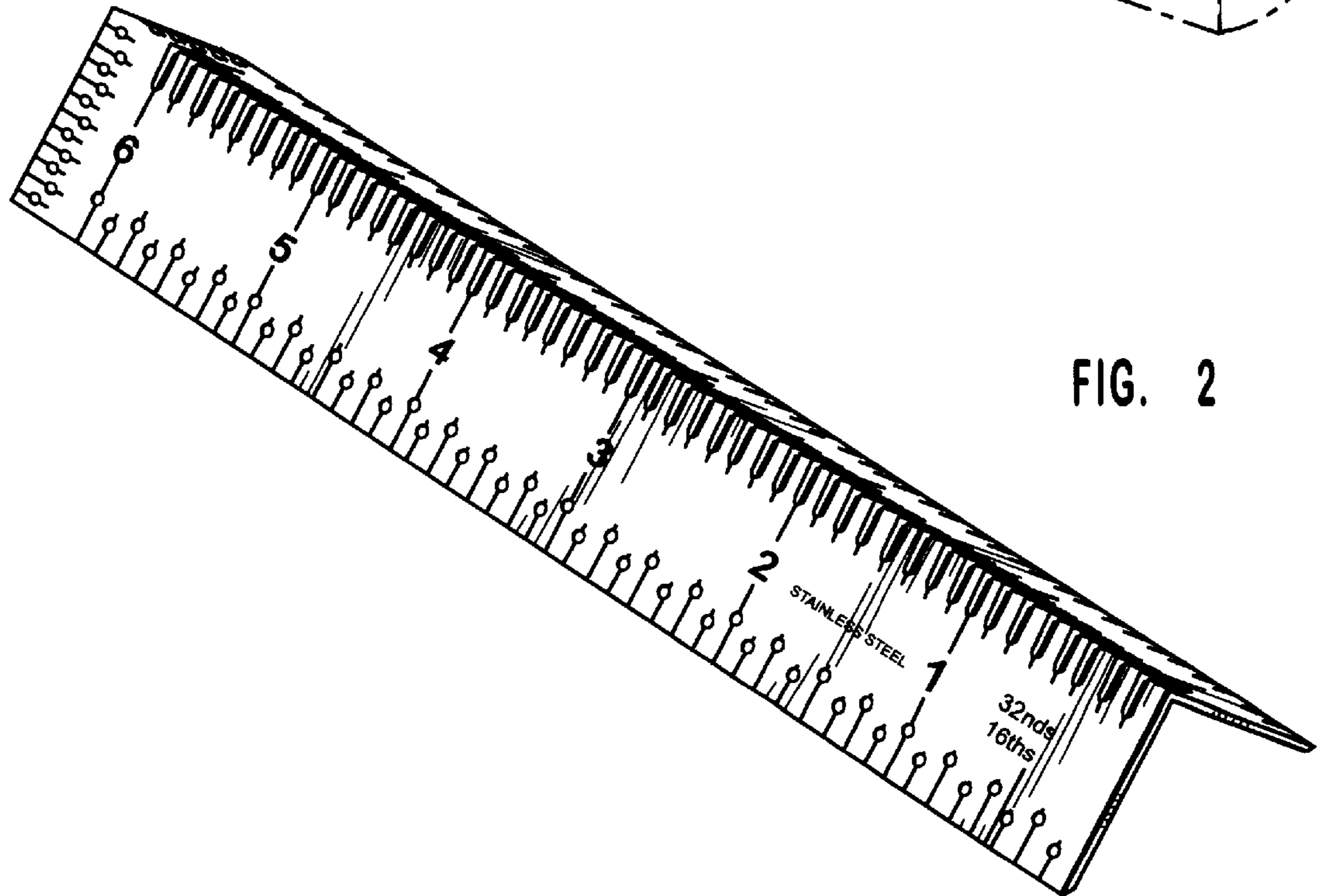
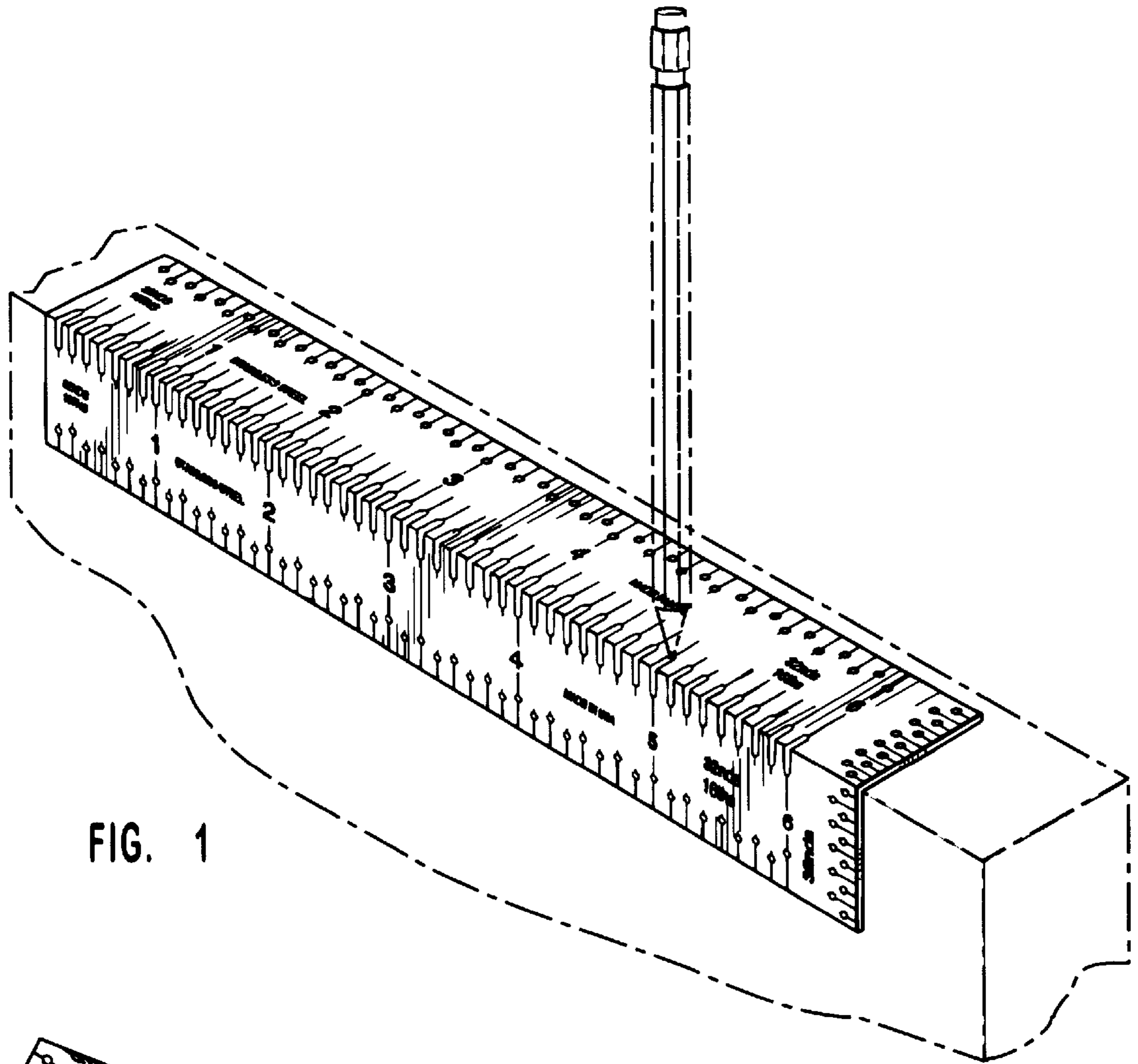

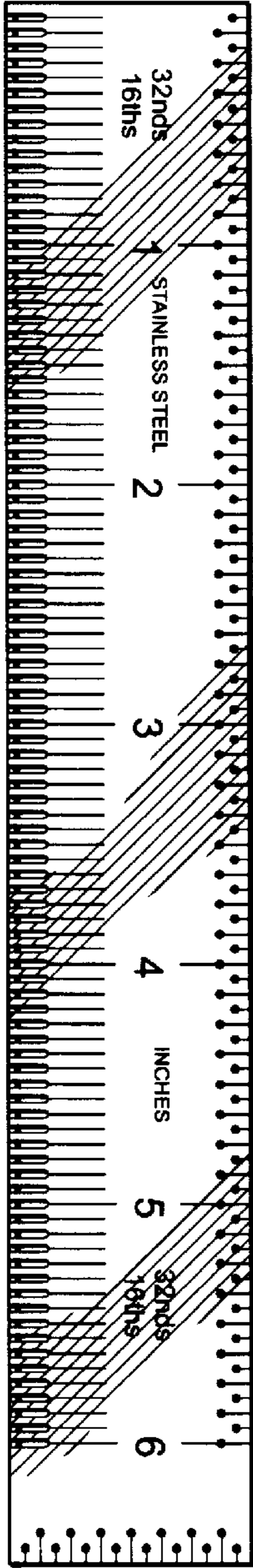

FIG. 3

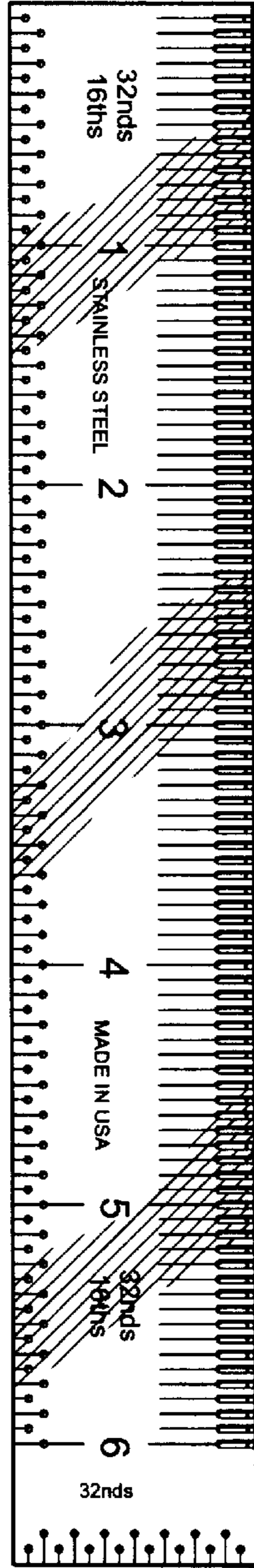

FIG. 4

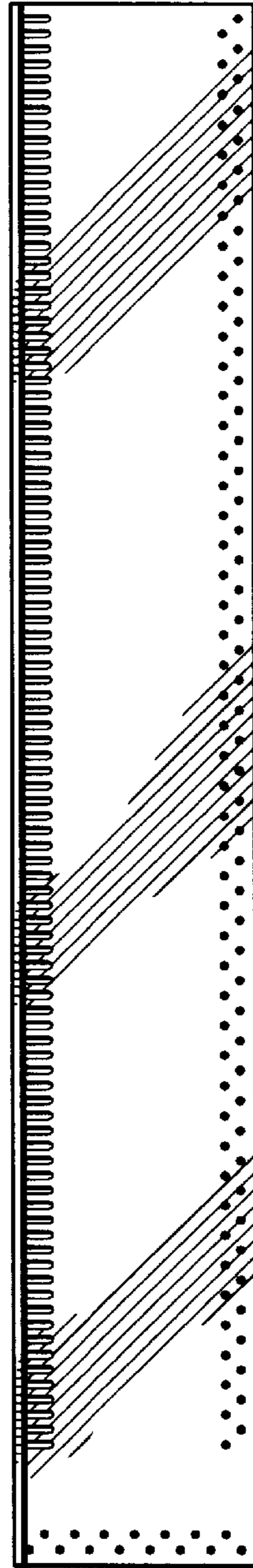

FIG. 5

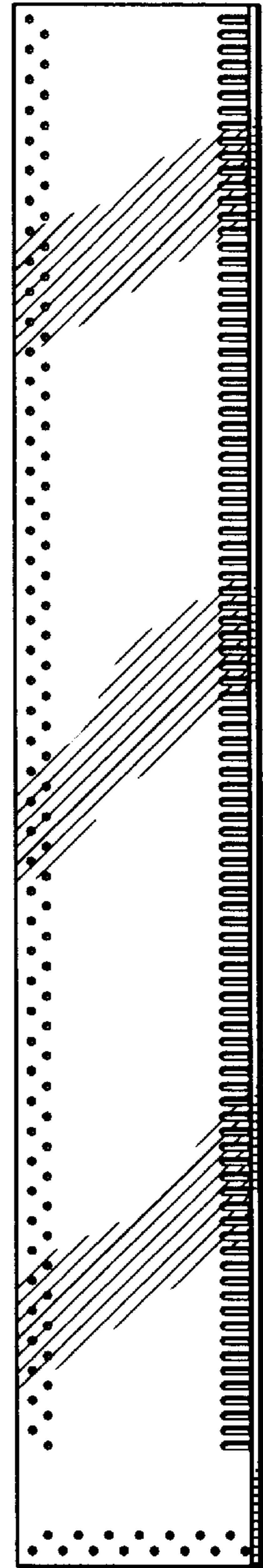

FIG. 6

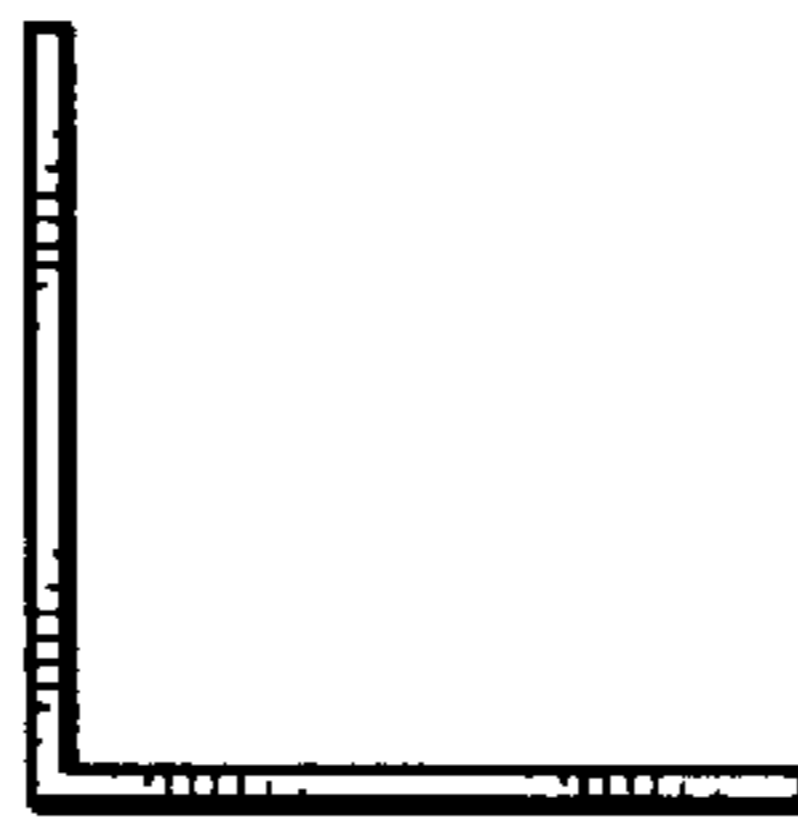

FIG. 7

UNITED STATES PATENT AND TRADEMARK OFFICE
CERTIFICATE OF CORRECTION

PATENT NO. : Des. 399,440
DATED : October 13, 1998
INVENTOR(S) : Christopher L. Taylor

It is certified that error appears in the above-identified patent and that said Letters Patent is hereby corrected as shown below:

On the cover page, under item [22] Filed: please delete "Jun. 23, 1997" and insert --Apr. 1, 1997--.

Signed and Sealed this
Seventh Day of March, 2000

Attest:



Q. TODD DICKINSON

Attesting Officer

Commissioner of Patents and Trademarks