



US00D399426S

United States Patent [19]

Jivago

[11] **Patent Number: Des. 399,426**

[45] **Date of Patent: **Oct. 13, 1998**

[54] **2-PART MEN'S FRAGRANCE BOTTLE**

[76] Inventor: **Ilana V. Jivago**, 9454 Wilshire Blvd.,
6th Floor, Beverly Hills, Calif. 90212

[**] Term: **14 Years**

[21] Appl. No.: **76,117**

[22] Filed: **Sep. 4, 1997**

[51] **LOC (6) Cl. 09-01**

[52] **U.S. Cl. D9/517; D9/521; D9/529**

[58] **Field of Search D9/300, 307, 517,
D9/521, 529, 559, 546; D28/91.1; 215/382,
400; D11/143, 146**

[56] **References Cited**

U.S. PATENT DOCUMENTS

D. 91,609	2/1934	De Botelho	D9/521 X
D. 194,812	3/1963	Jurutka	D9/521
D. 310,487	9/1990	Genaro	D9/521 X
D. 323,111	1/1992	Restrepo	D9/329 X
D. 375,047	10/1996	Jivago	D9/521

Primary Examiner—Terry A. Wallace

Attorney, Agent, or Firm—Beveridge, DeGrandi, Weilacher
& Young, L.L.P.

[57] **CLAIM**

The ornamental design for a 2-part mens' fragrance bottle,
as shown and described.

DESCRIPTION

FIG. 1 is a perspective view of the 2-part mens' fragrance
bottle showing my new design;

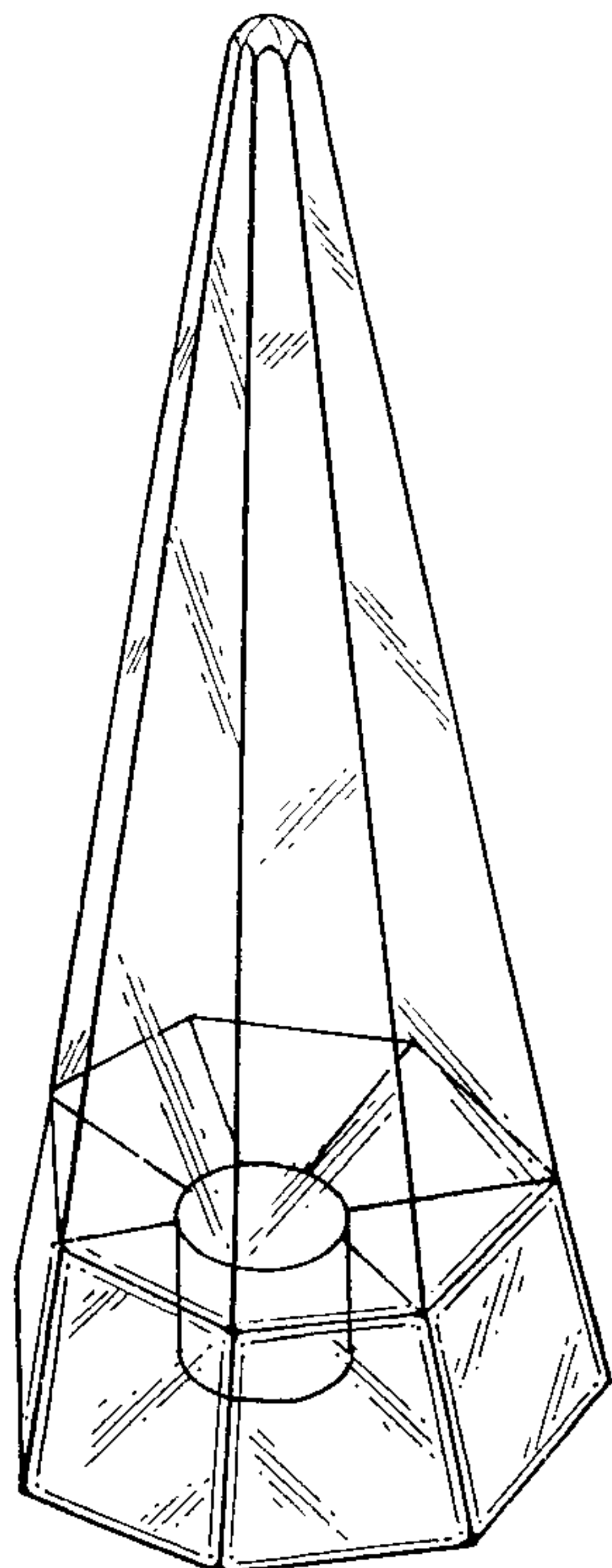

FIG. 2 is a front elevation view thereof including the bottle
and base;

FIG. 3 is a top view thereof;

FIG. 4 is a bottom view thereof;

FIG. 5 is a left side elevation view thereof;

FIG. 6 is a right side elevation view thereof;

FIG. 7 is a perspective view thereof showing how the bottle
is supported in the base;

FIG. 8 is a front elevational view of the bottle without the
base;

FIG. 9 is a top view of the bottle without the base;

FIG. 10 is a bottom view of the bottle without the base;

FIG. 11 is a left side elevation view of the bottle;

FIG. 12 is a right side elevation view of the bottle;

FIG. 13 is a front elevation view of the base;

FIG. 14 is a top view of the base;

FIG. 15 is a bottom view of the base;

FIG. 16 is a left side elevation view of the base; and,

FIG. 17 is a right side elevation view of the base.

1 Claim, 5 Drawing Sheets

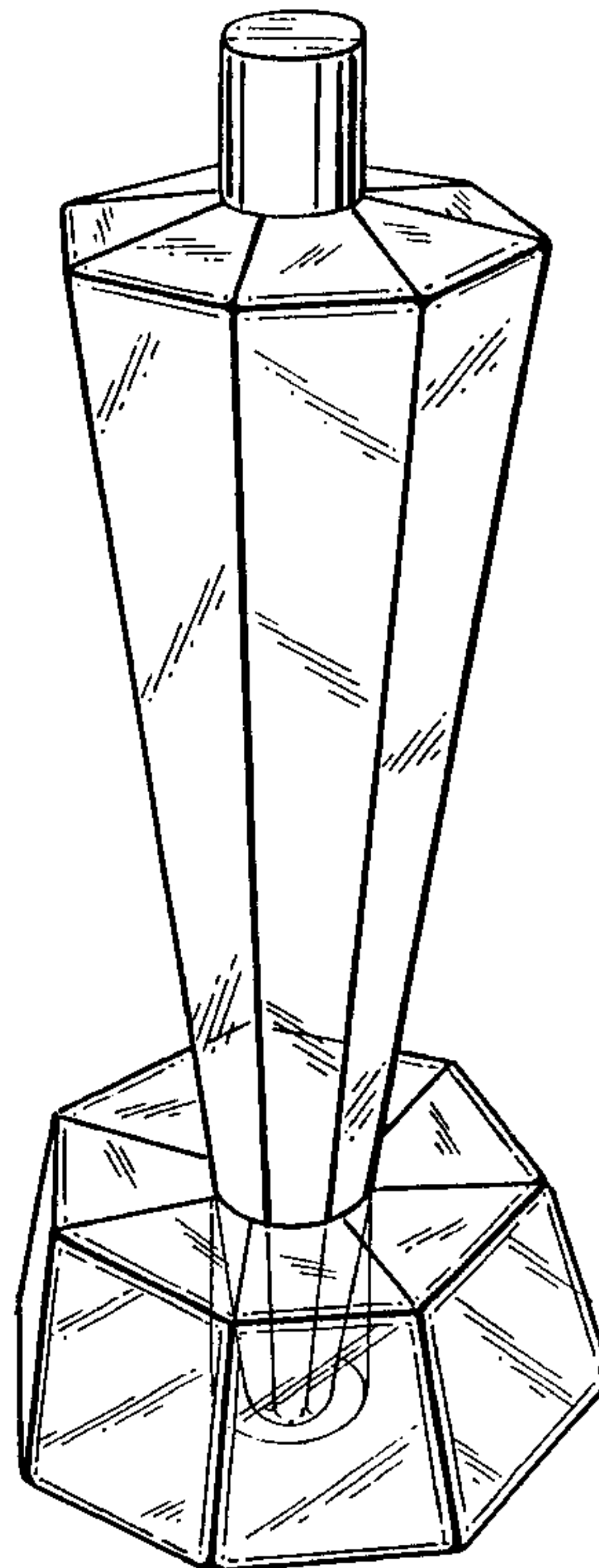

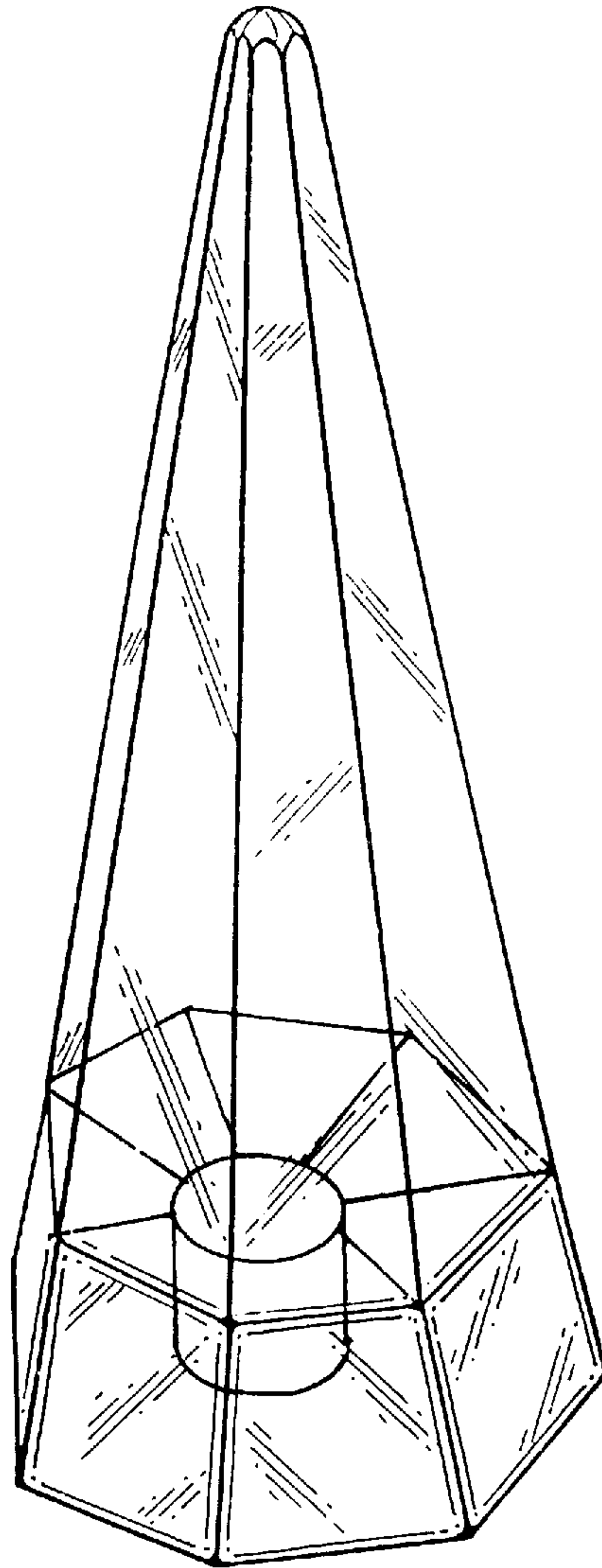

FIG. 1

FIG. 2

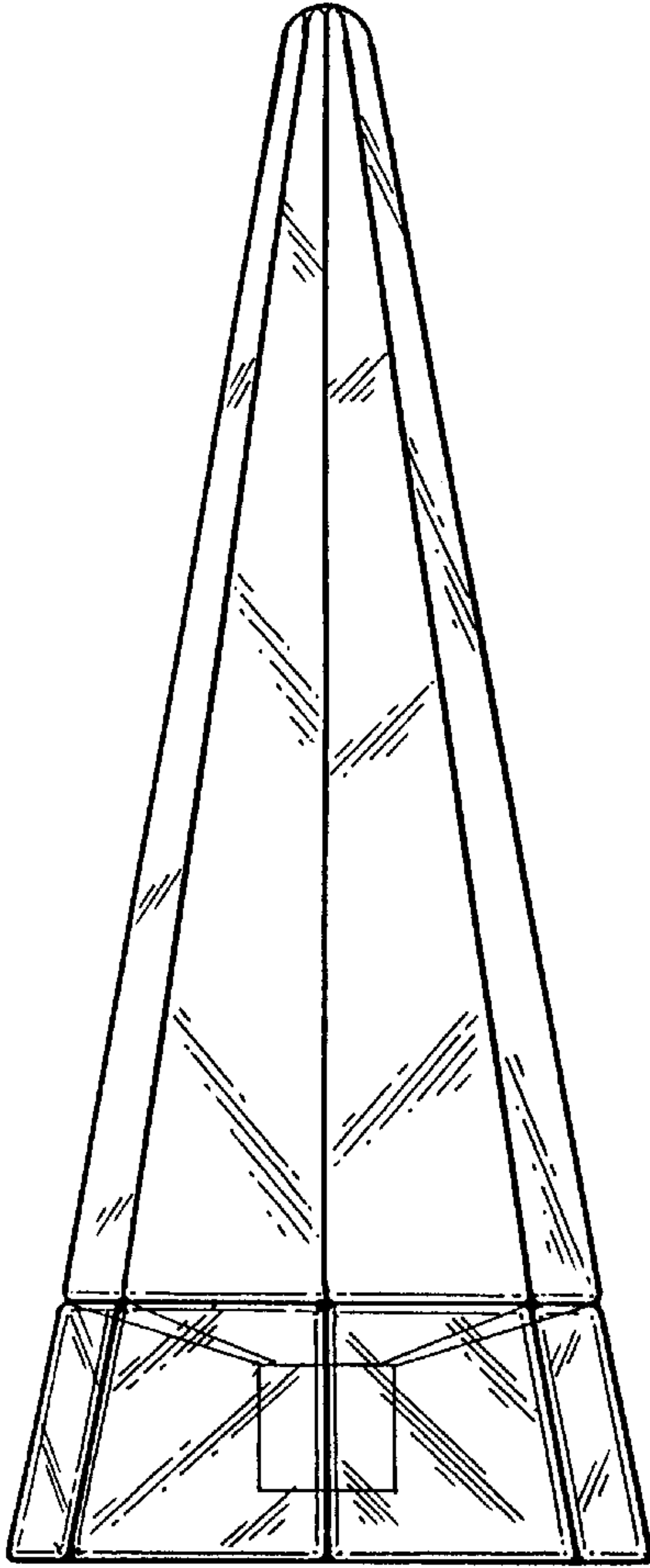

FIG. 5

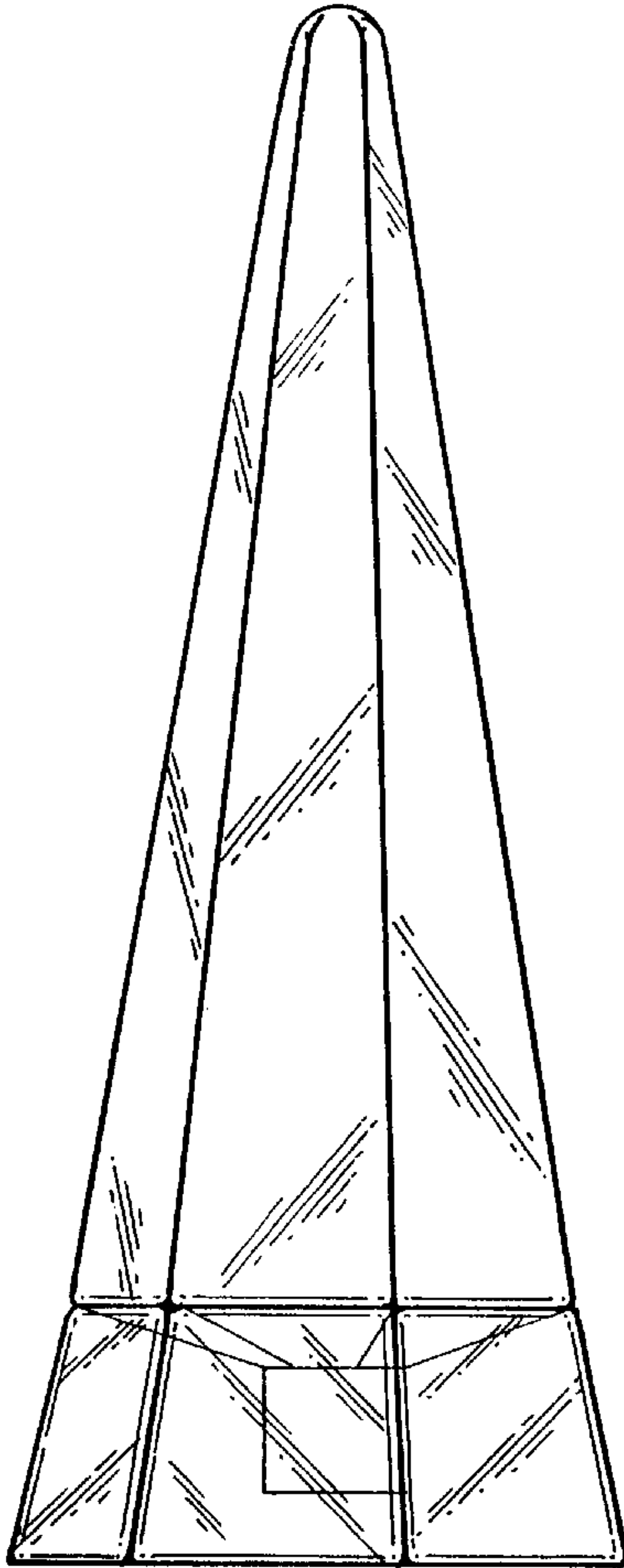

FIG. 6

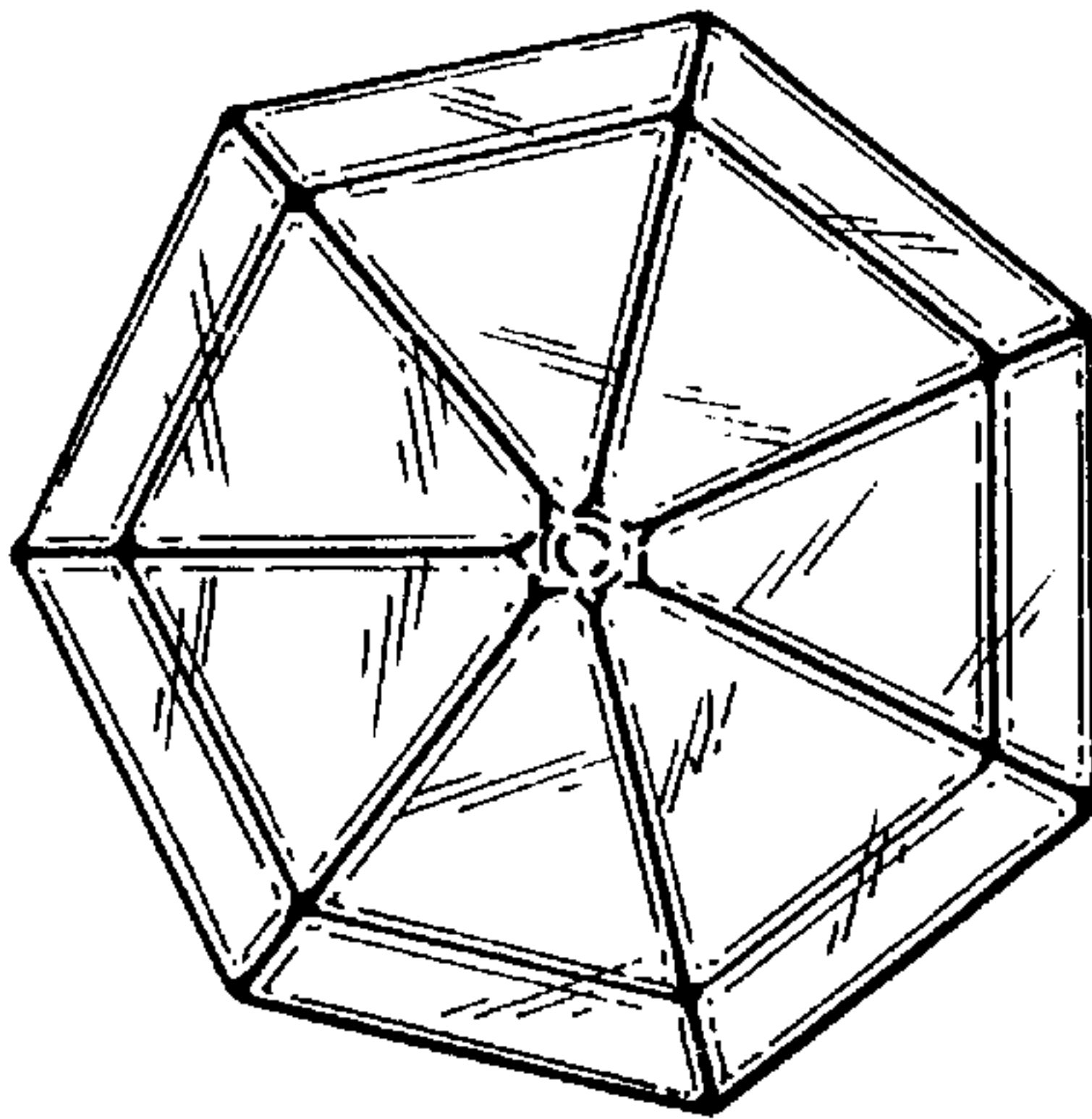

FIG. 3

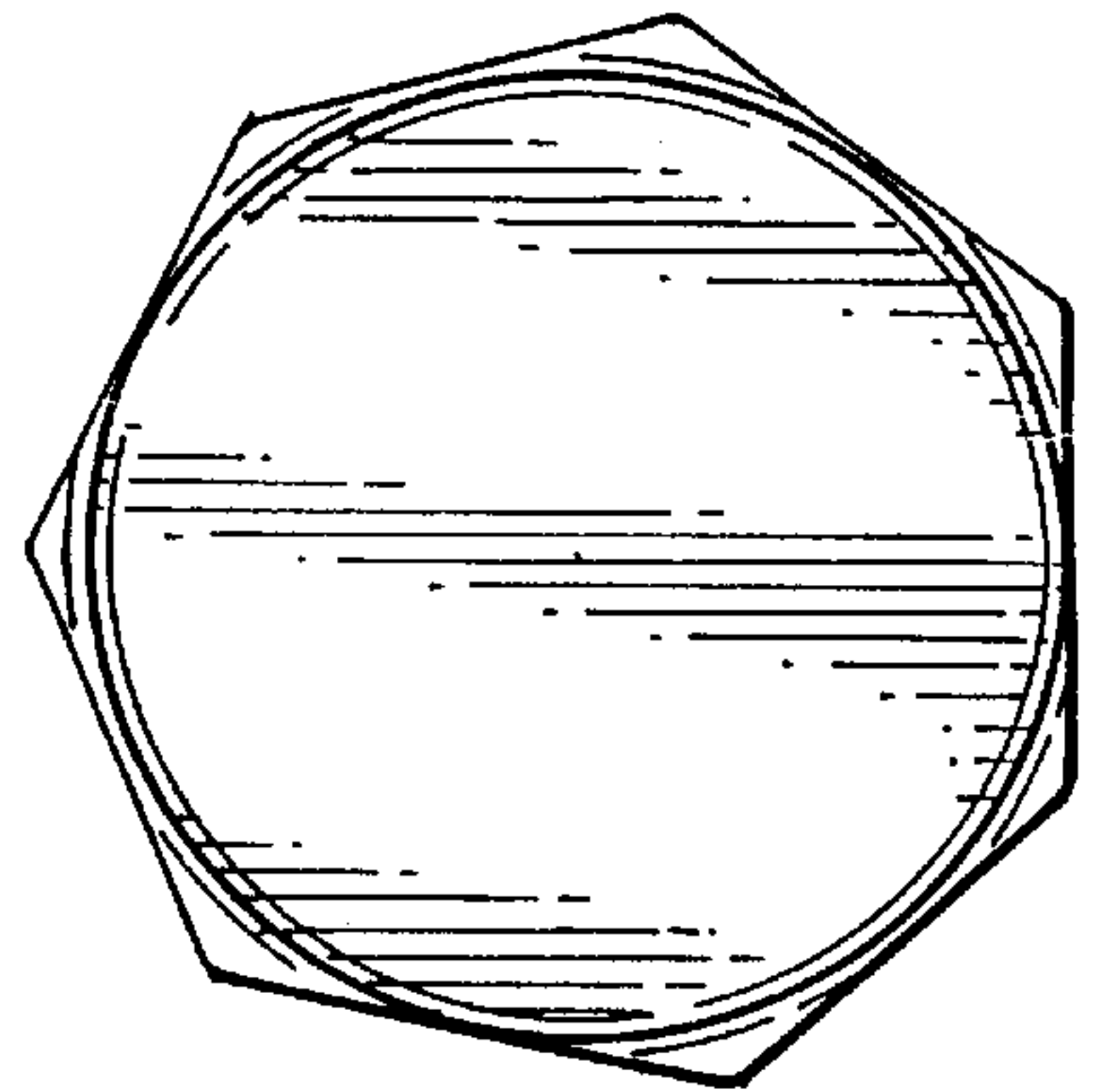

FIG. 4

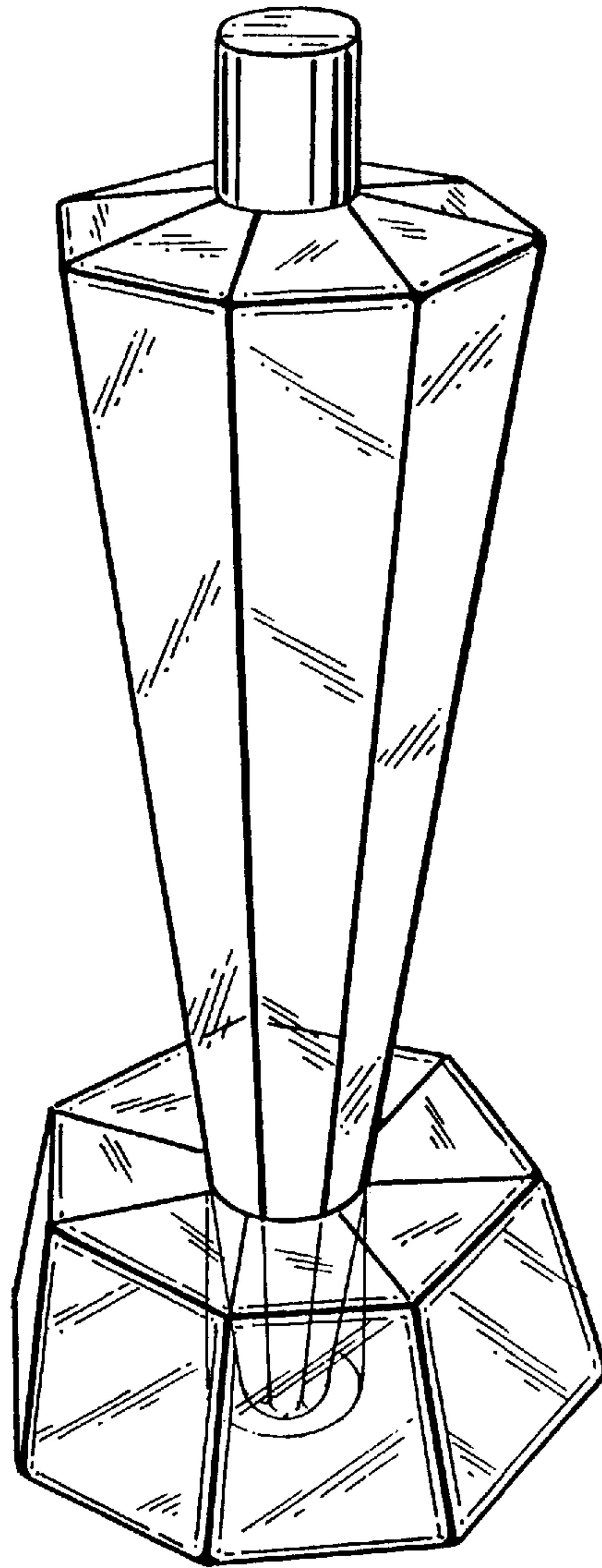

FIG. 7

FIG. 8

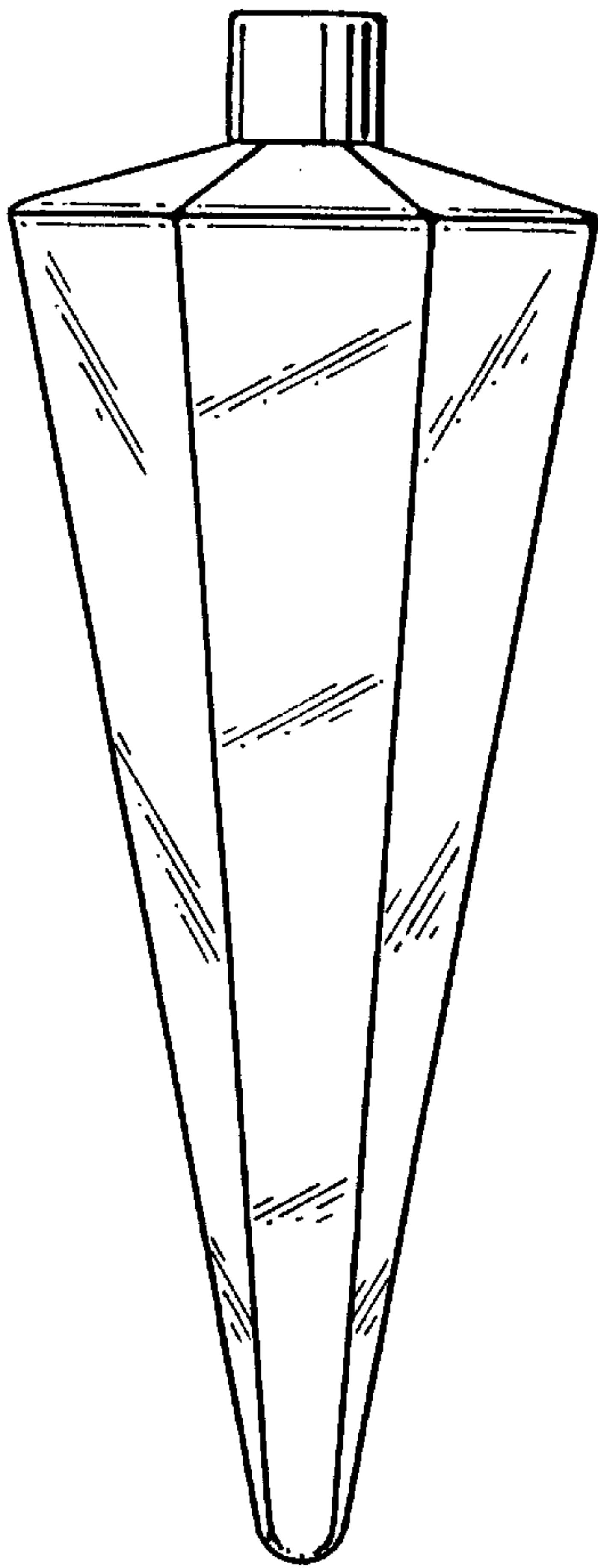

FIG. 11

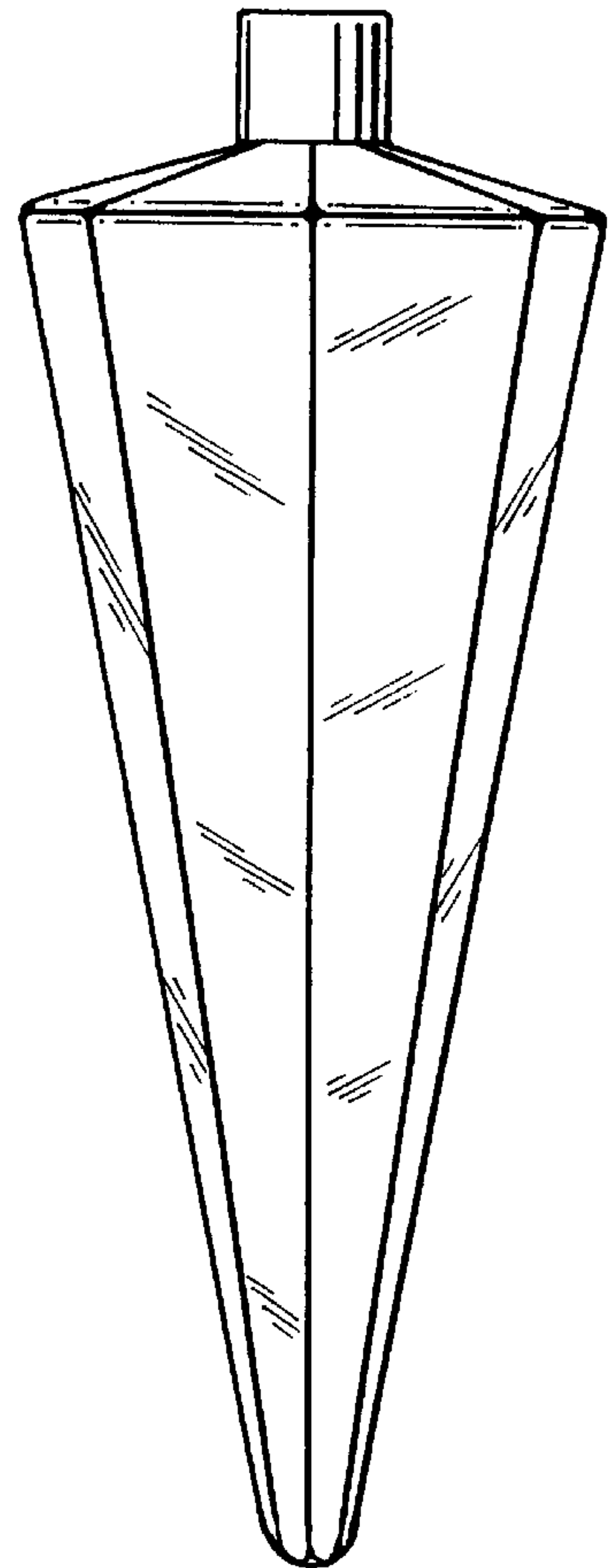
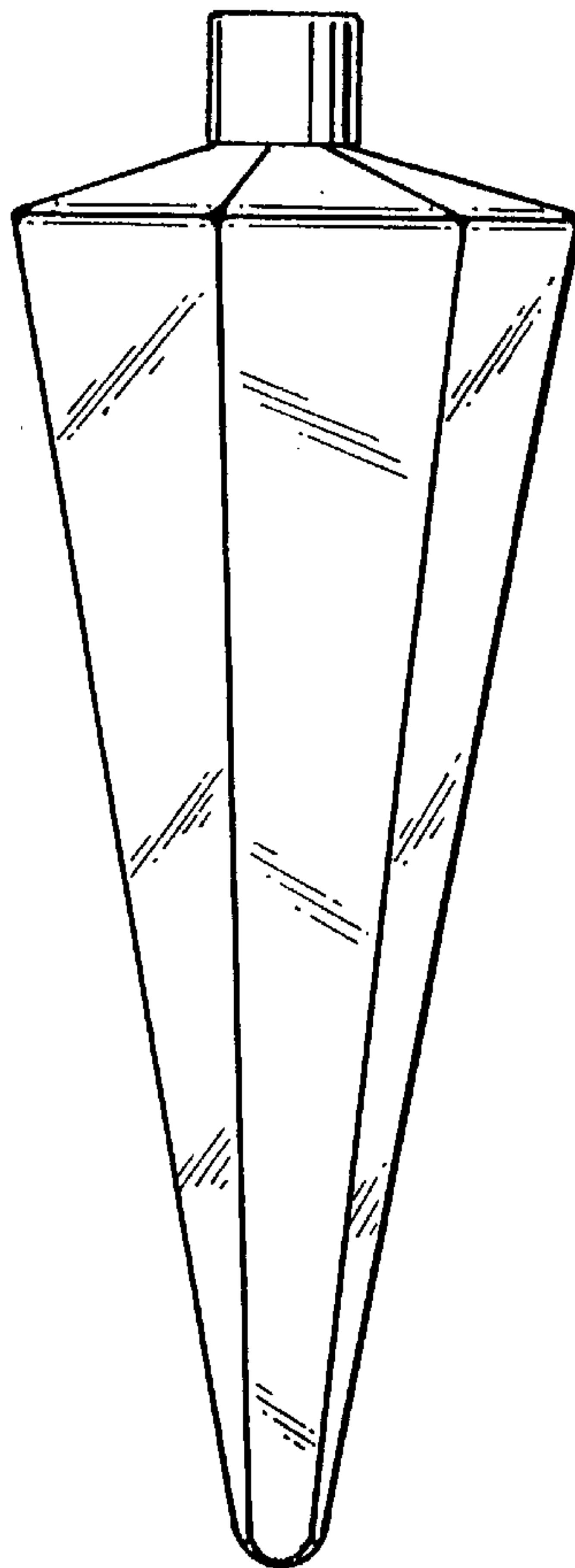

FIG. 13

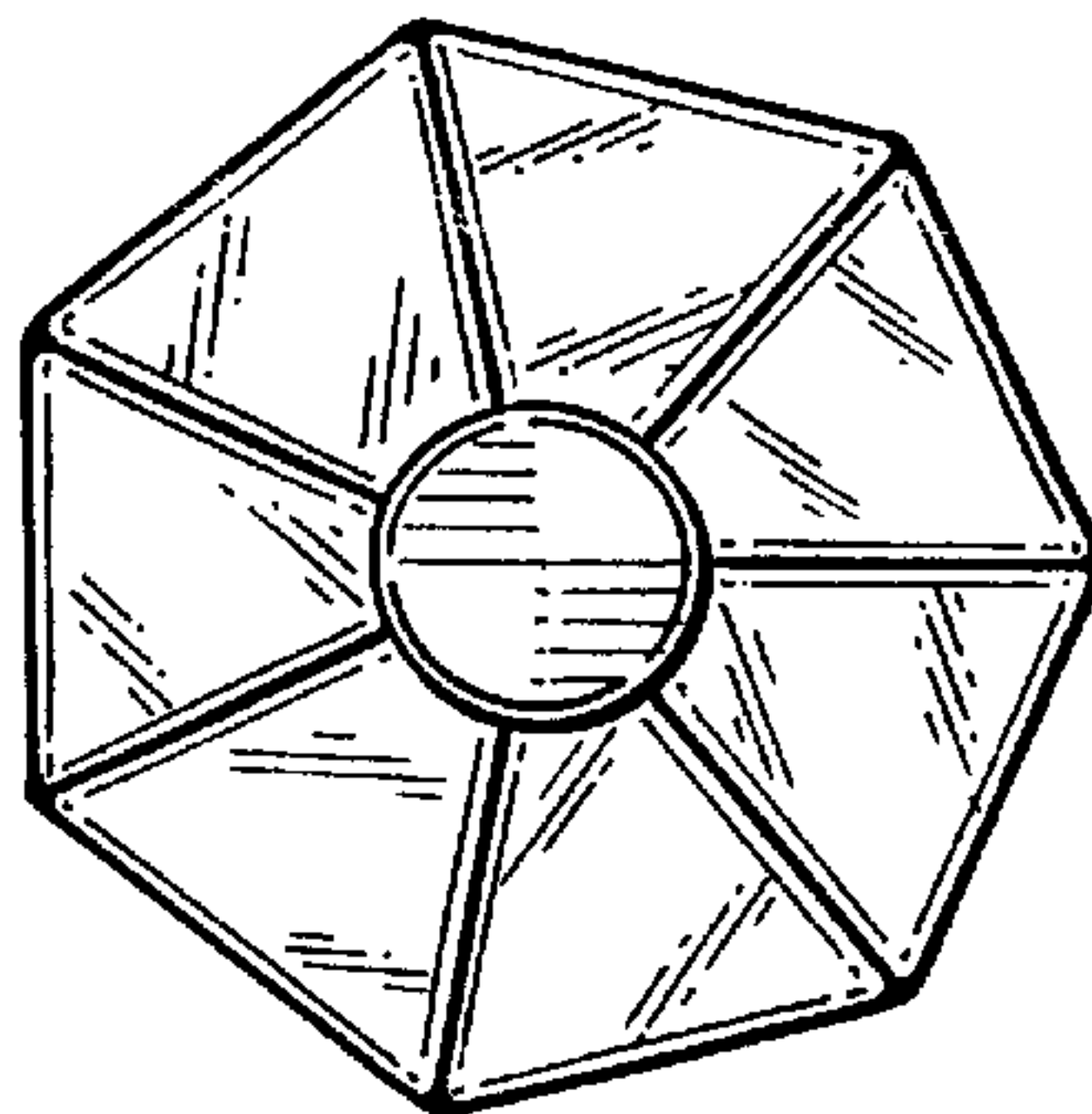

FIG. 9

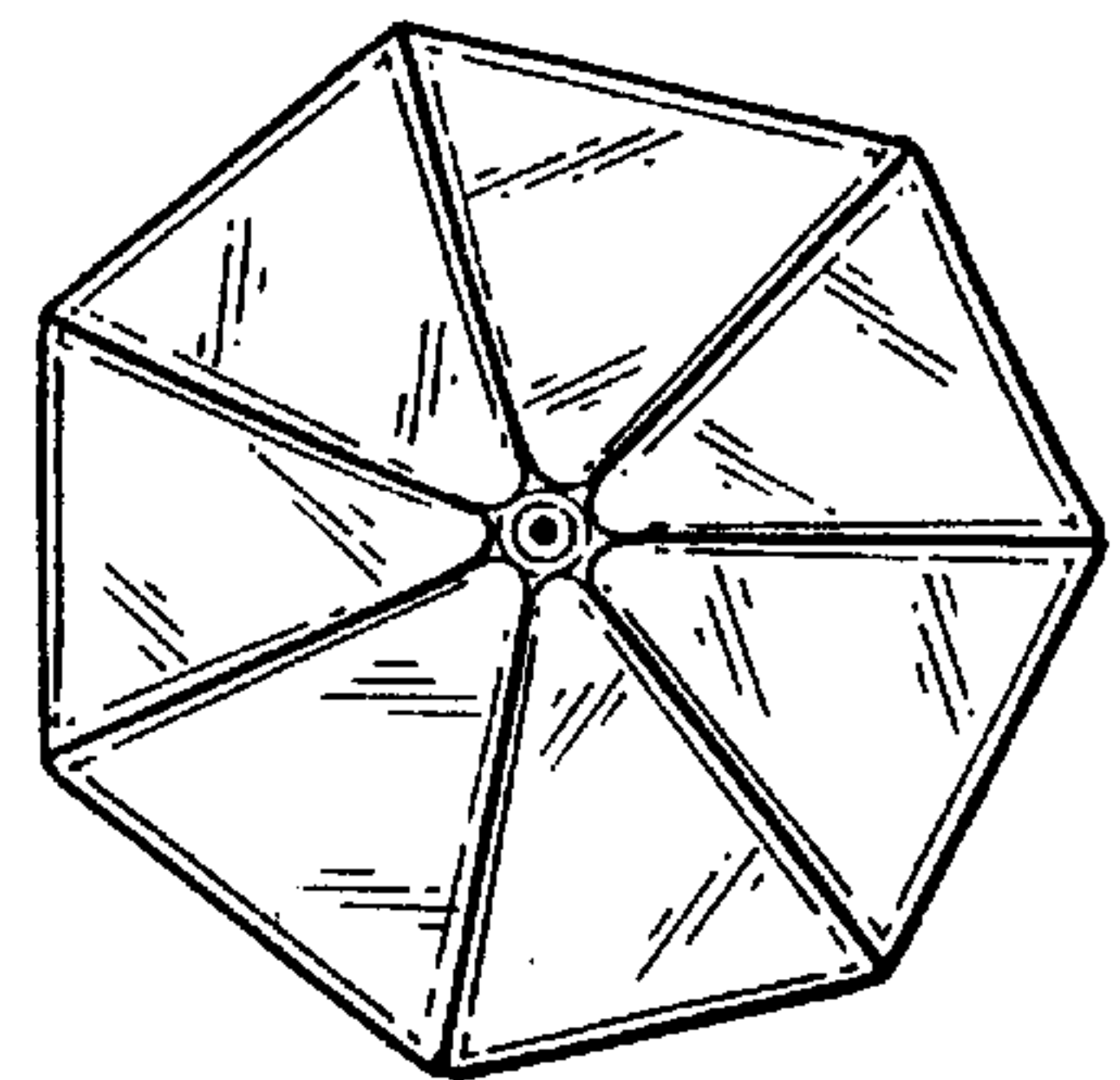

FIG. 10

FIG.13

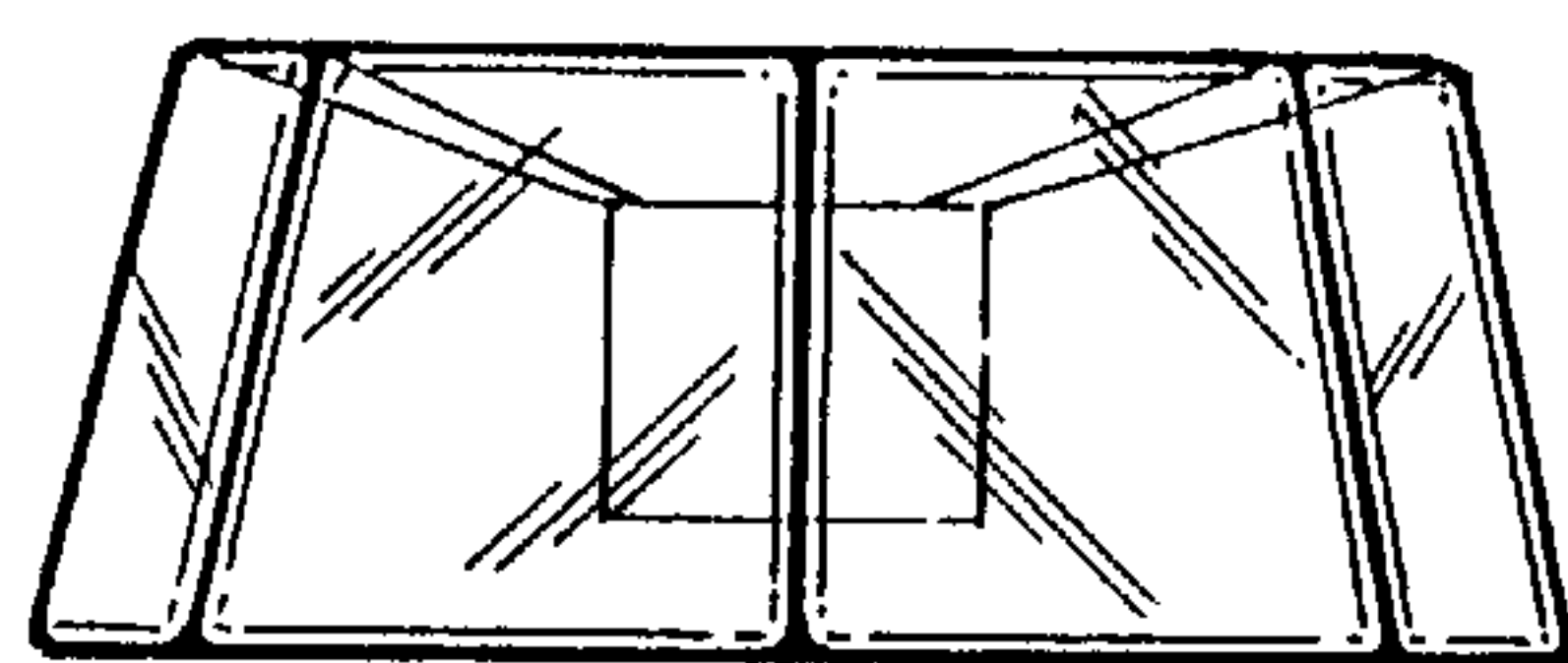

FIG.16

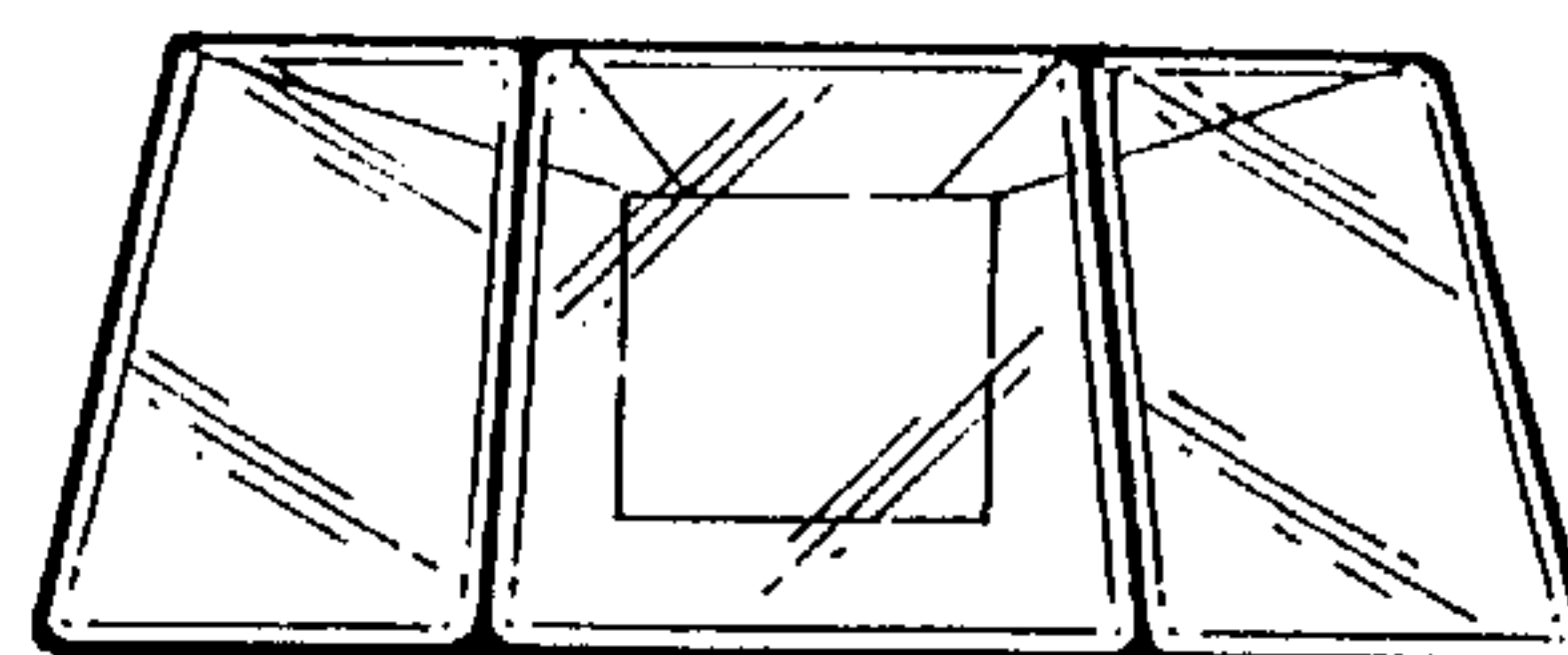
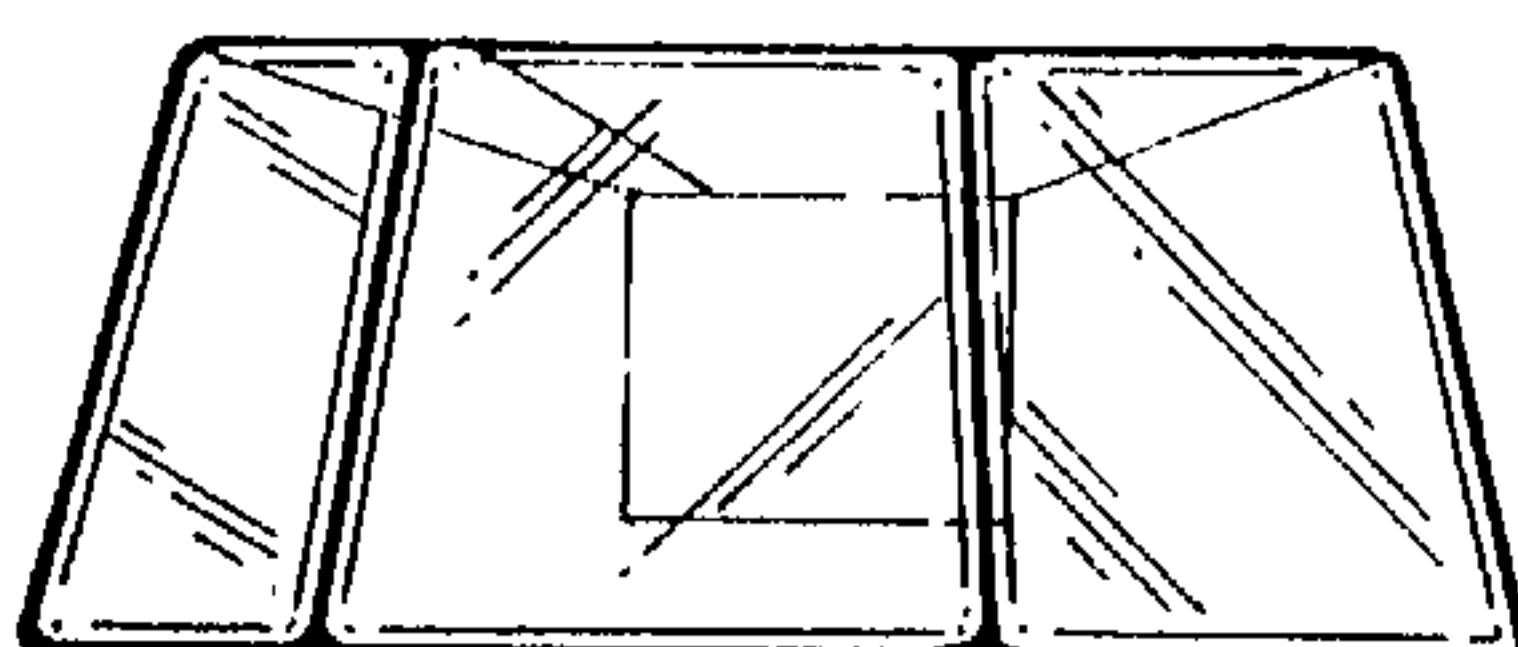

FIG.17

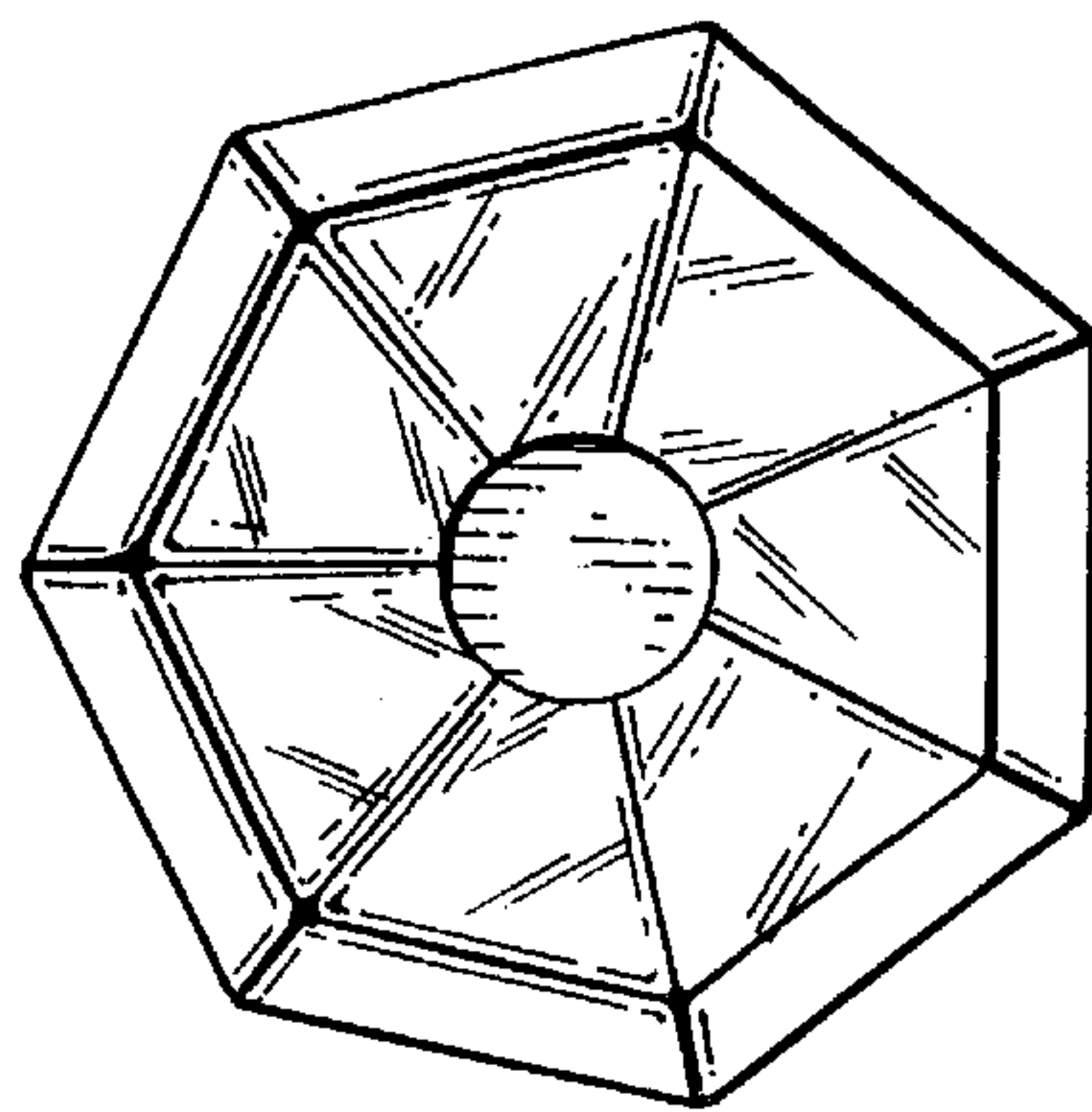

FIG.14

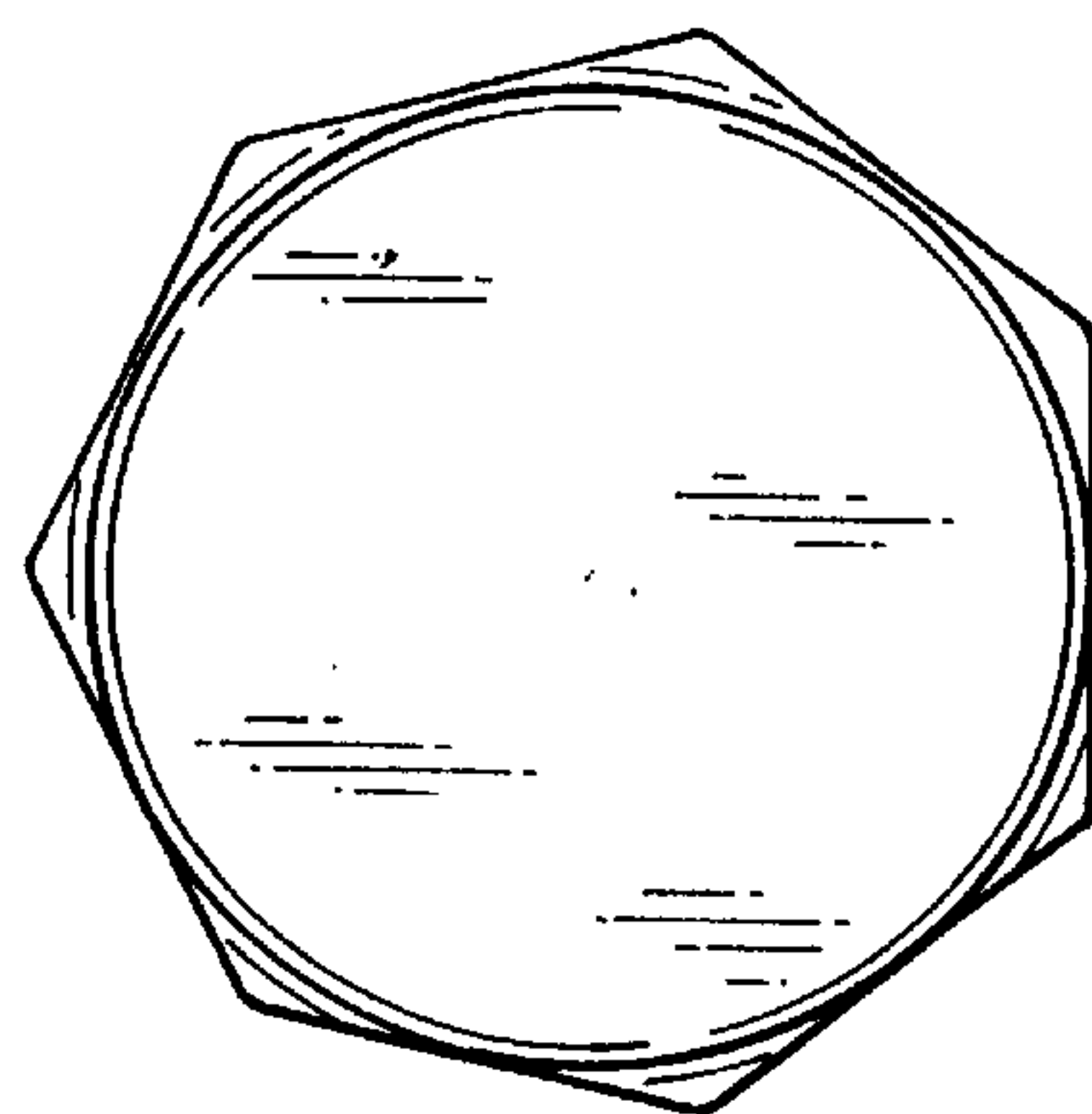

FIG.15