



US00D399364S

United States Patent [19]

[11] **Patent Number: Des. 399,364**

Natuzzi et al.

[45] **Date of Patent: **Oct. 13, 1998**

[54] **SEAT**

[75] Inventors: **Pasquale Natuzzi; Raffaella Lucarelli,**
both of Santeramo In Colle, Italy

[73] Assignee: **Industrie Natuzzi, Spa,** Santeramo,
Italy

[**] Term: **14 Years**

[21] Appl. No.: **76,863**

[22] Filed: **Sep. 15, 1997**

[51] **LOC (6) Cl. 06-01**

[52] **U.S. Cl. D6/381; D6/334**

[58] **Field of Search D6/334, 335, 364,**
D6/371, 373, 381, 500, 501, 502; 297/232,
445.1

[56] **References Cited**

U.S. PATENT DOCUMENTS

D. 246,143	10/1977	Nash	D6/381
D. 353,061	12/1994	Natuzzi et al.	D6/381
D. 367,180	2/1996	Natuzzi et al.	D6/381

OTHER PUBLICATIONS

Natuzzi Model 404, Oct. 1987, at International Home Furnishings Market in High Point, North Carolina.
 Natuzzi Model 638, Apr. 1990, at International Home Furnishings Market in High Point, North Carolina.
 Natuzzi Model 723, Oct. 1989, at International Home Furnishings Market in High Point, North Carolina.
 Natuzzi Model 728, Oct. 1989, at International Home Furnishings Market in High Point, North Carolina.
 Natuzzi Model 736, Apr. 1990, at International Home Furnishings Market in High Point, North Carolina.
 Natuzzi Model 739, Apr. 1990, at International Home Furnishings Market in High Point, North Carolina.
 Natuzzi Model 742, Apr. 1990, at International Home Furnishings Market in High Point, North Carolina.
 Natuzzi Model 756, Apr. 1990, at International Home Furnishings Market in High Point, North Carolina.
 Natuzzi Model 763, Apr. 1990, at International Home Furnishings Market in High Point, North Carolina.

Natuzzi Model 782, Oct. 1990, at International Home Furnishings Market in High Point, North Carolina.
 Natuzzi Model 938, Apr. 1992, at International Home Furnishings Market in High Point, North Carolina.
 Natuzzi Model 1029, Apr. 1993, At International Home Furnishings Market in High Point, North Carolina.
 Natuzzi Model 1128, Jan. 1994, at International Home Furnishings Market in High Point, North Carolina.
 Natuzzi Model 1147, Apr. 1994, at International Home Furnishings Market in High Point, North Carolina.
 Natuzzi Model 1157, Apr. 1994, at International Home Furnishings Market in High Point, North Carolina.
 Natuzzi Model 1165, Apr. 1994, at International Home Furnishings Market in High Point, North Carolina.

(List continued on next page.)

Primary Examiner—Gary D. Watson
Attorney, Agent, or Firm—Bell Seltzer Intellectual Property Law Group of Alston & Bird LLP

[57] **CLAIM**

The ornamental design for a seat, as shown and described.

DESCRIPTION

FIG. 1 is a front perspective view of a seat showing our new design in the form of a sofa;
 FIG. 2 is a front elevational view thereof;
 FIG. 3 is a top plan view thereof;
 FIG. 4 is a right side elevational view, the left side being a mirror image thereof;
 FIG. 5 is a rear perspective view thereof;
 FIG. 6 is a front elevational view of a seat showing our new design in the form of a loveseat; and,
 FIG. 7 is a front elevational view of a seat showing our new design in the form of a chair.
 The broken lines shown herein are for illustrative purposes only and form no part of the claimed design.
 The rear views of FIGS. 6 and 7 are like FIG. 5, the difference being a matter of length.
 The end views of FIGS. 6 and 7 are like FIG. 4.
 FIGS. 1 and 5 have been shown on an enlarged scale relative to the other views.

1 Claim, 3 Drawing Sheets

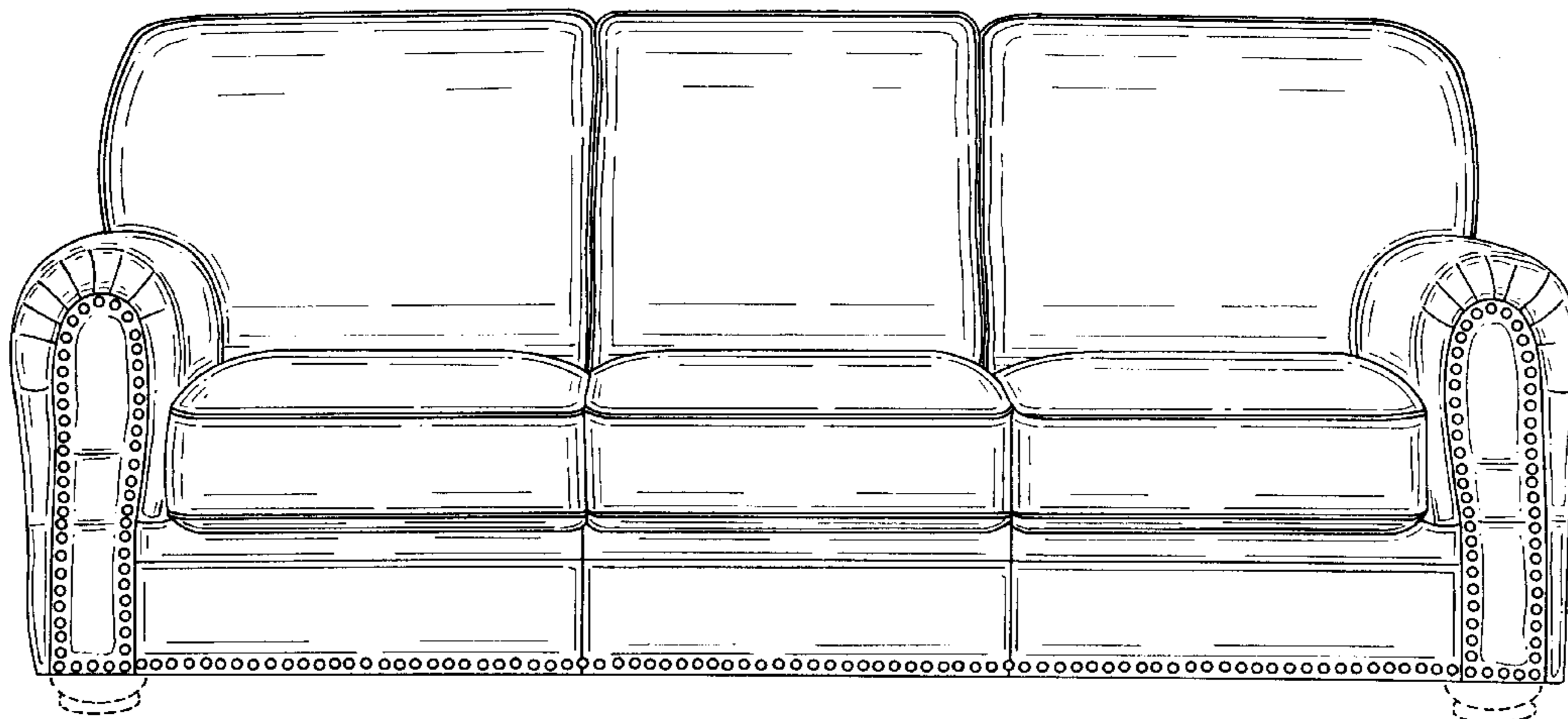

OTHER PUBLICATIONS

Natuzzi Model 1183, Apr. 1994, at International Home Furnishings Market in High Point, North Carolina.

Natuzzi Model 1200, Oct. 1994, at International Home Furnishings Market in High Point, North Carolina.

Natuzzi Model 1293, Mar. 1995, at International Home Furnishings Market in High Point, North Carolina.

Natuzzi Model 1349, Sep. 1995, at International Home Furnishings Market in High Point, North Carolina.

Natuzzi Model 1361, Sep. 1995, at International Home Furnishings Market in High Point, North Carolina.

Natuzzi Model 1369, Sep. 1995, at International Home Furnishings Market in High Point, North Carolina.

Natuzzi Model 1450, Mar. 1996, at International Home Furnishings Market in High Point, North Carolina.

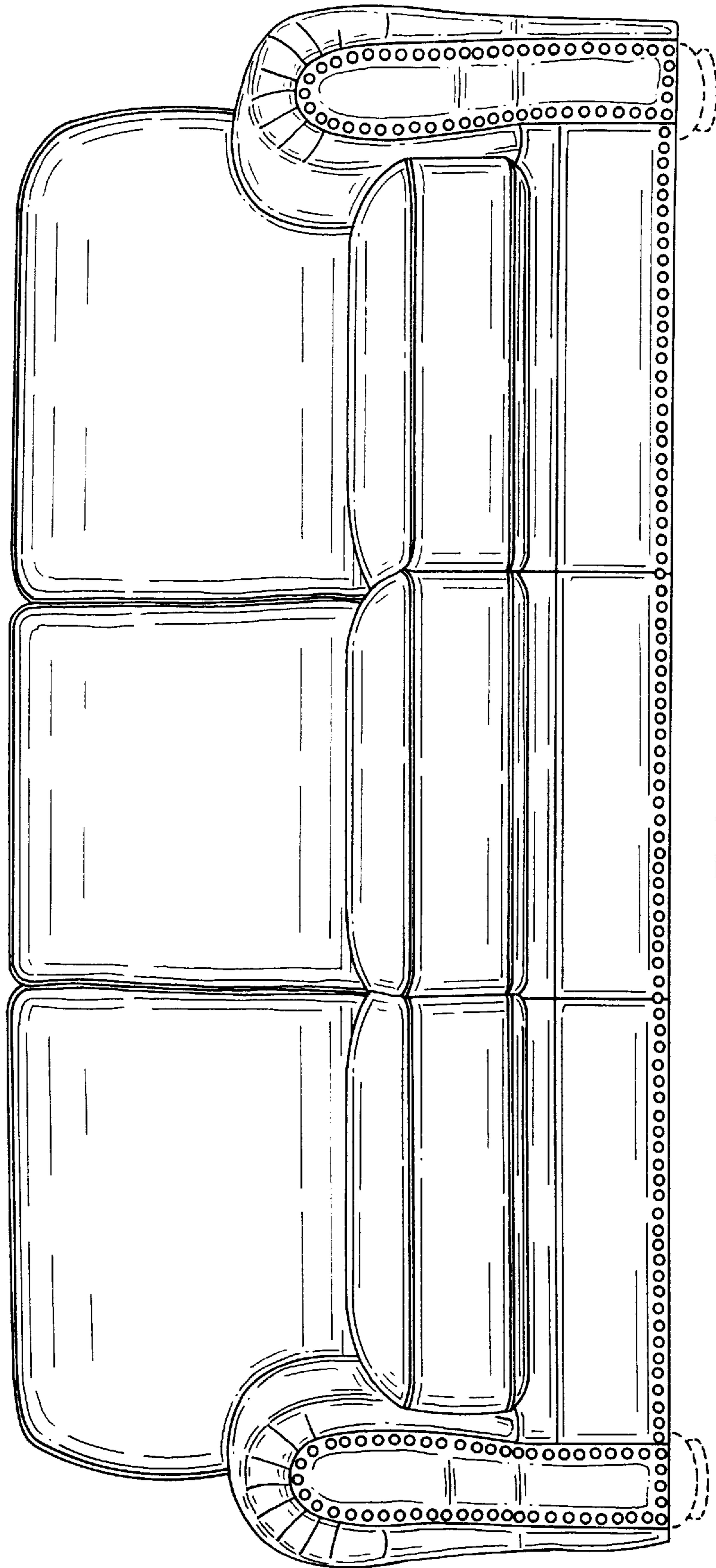

FIG. 1.

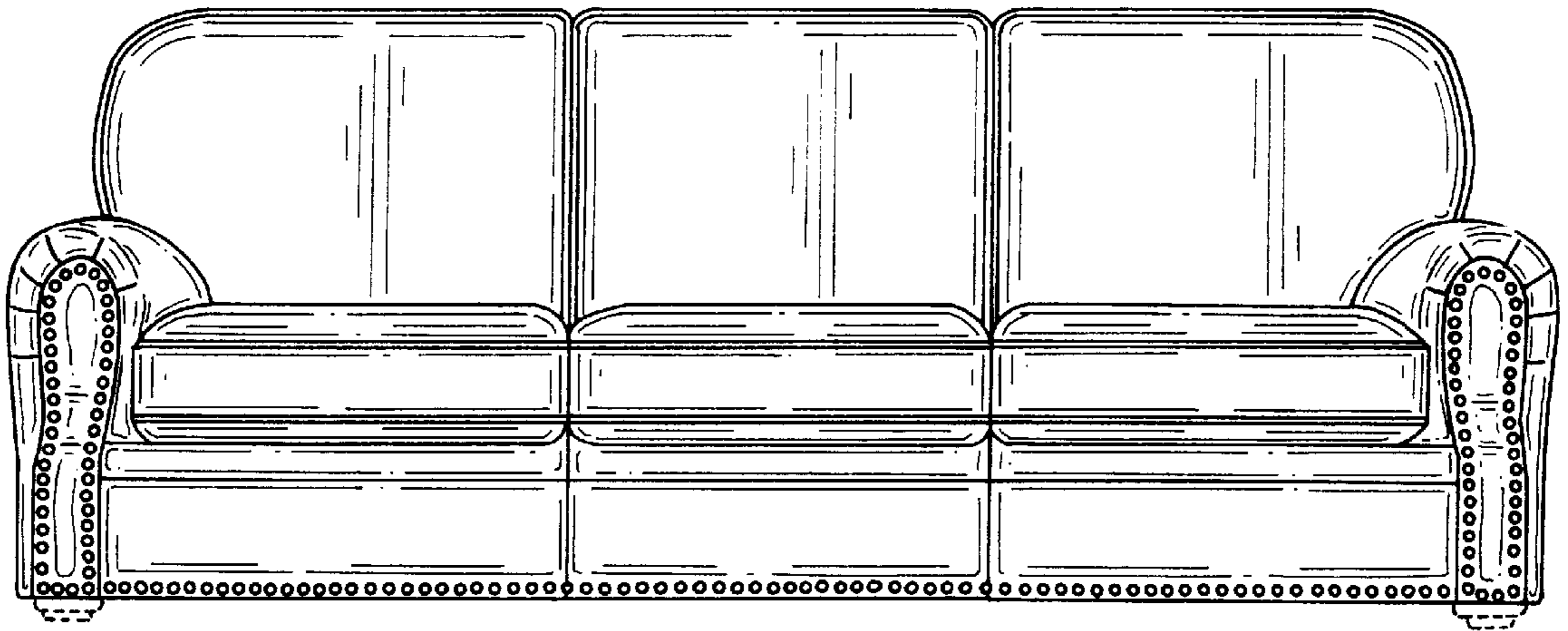

FIG. 2.

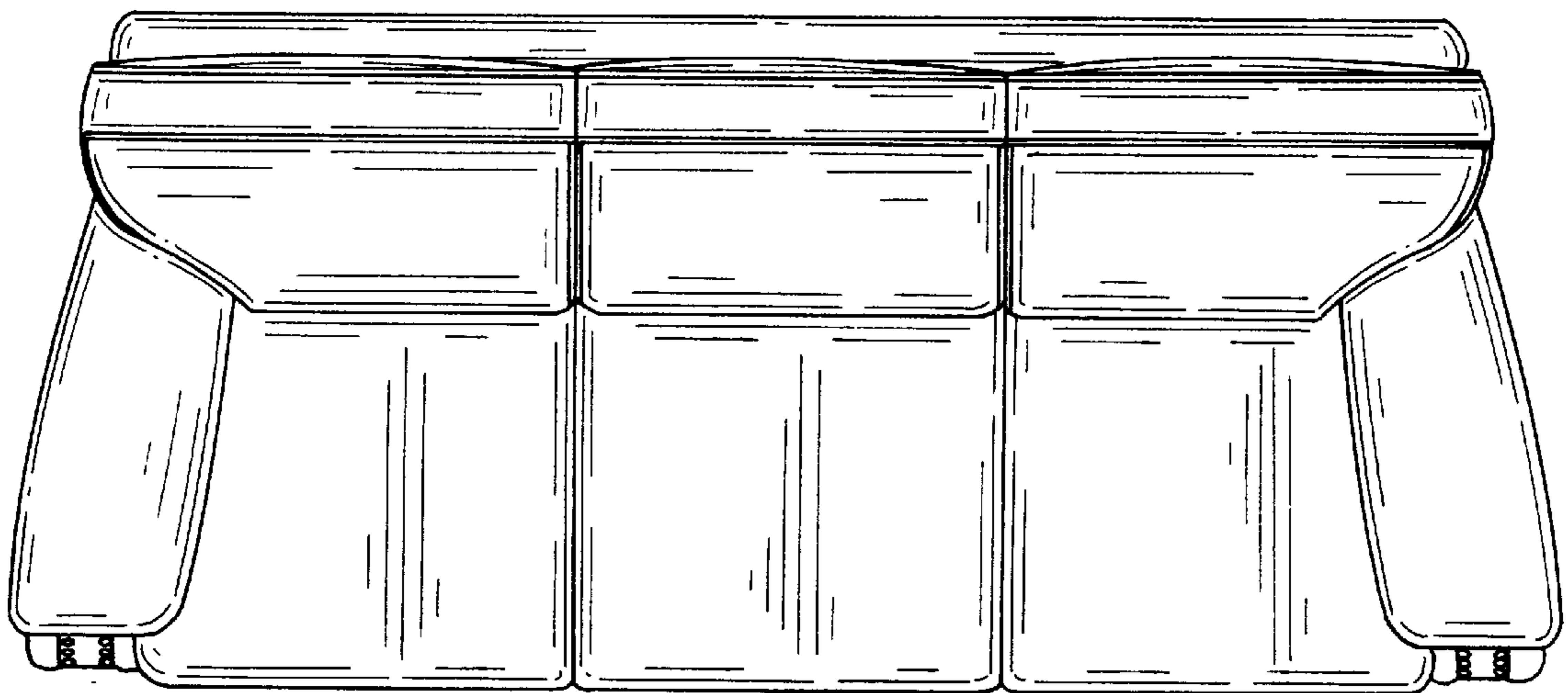

FIG. 3.

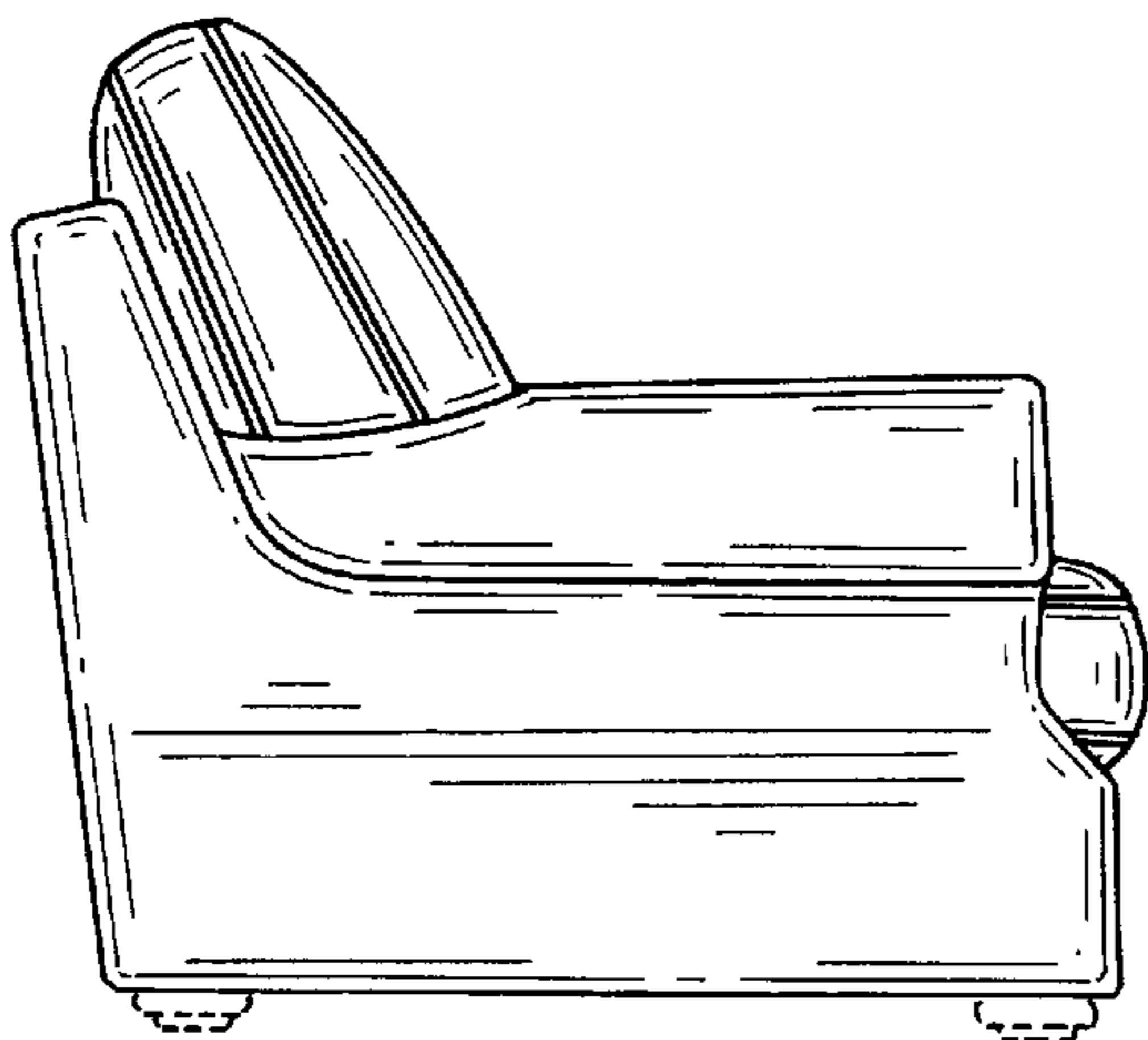

FIG. 4.

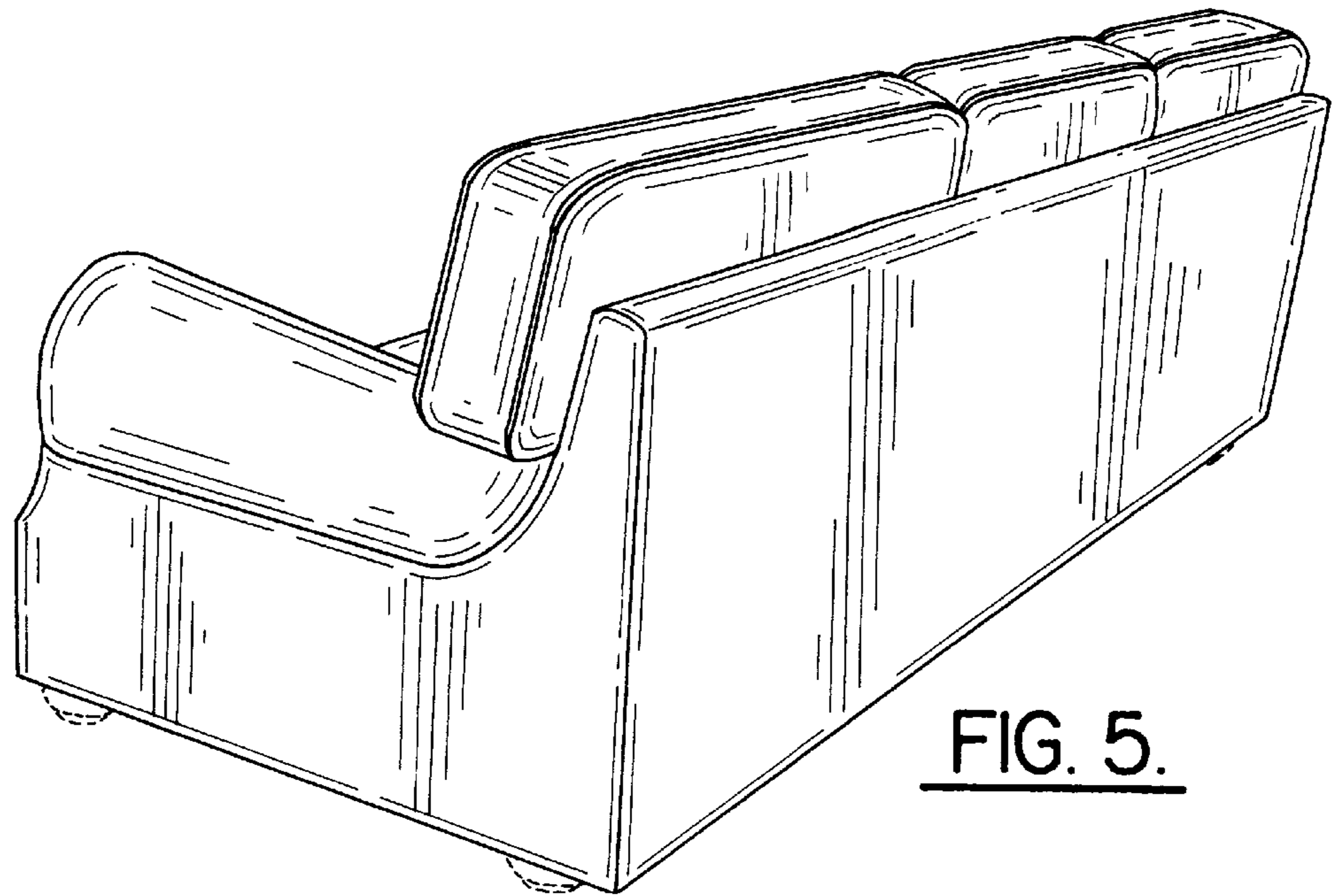

FIG. 5.

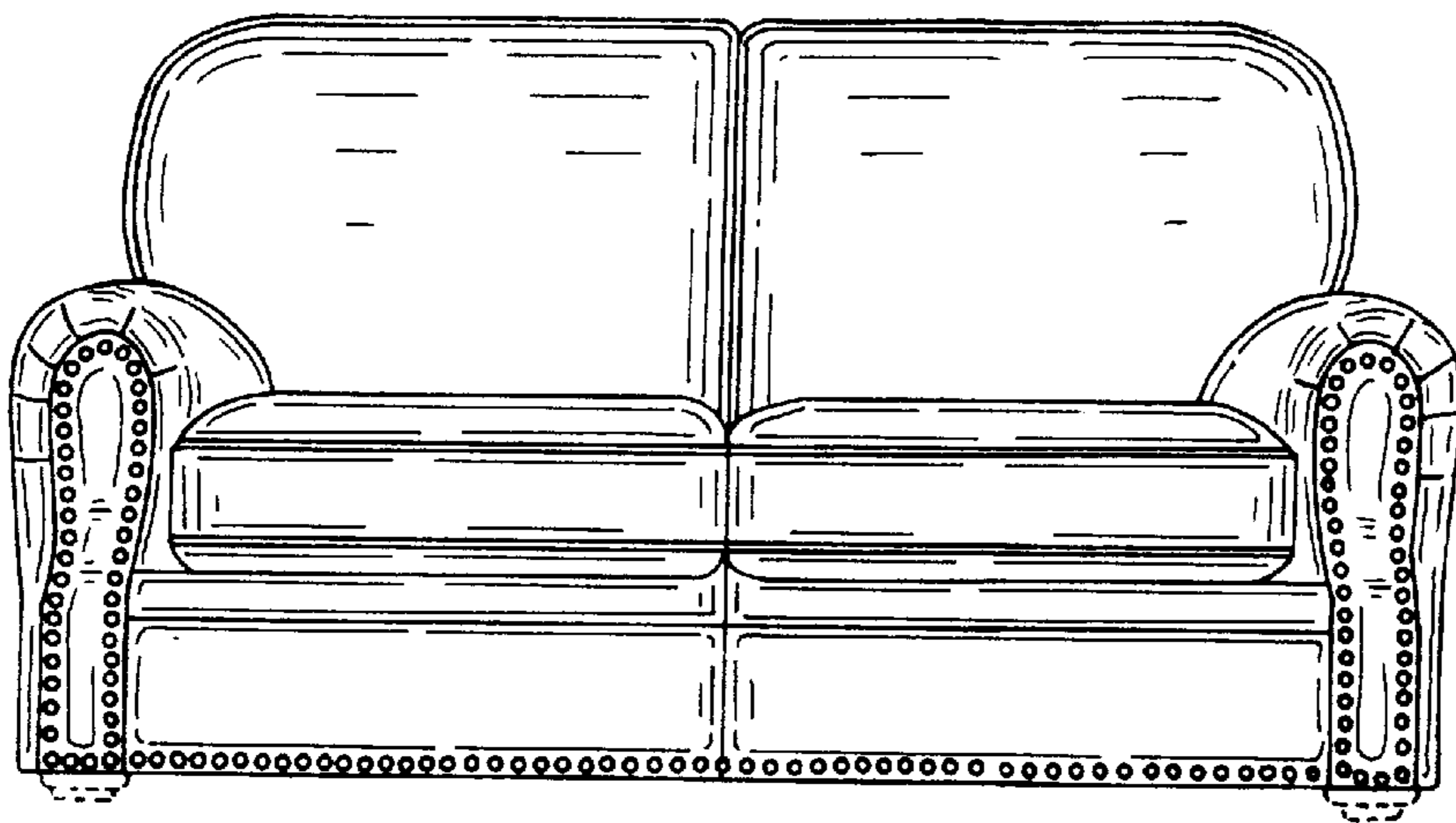

FIG. 6.

FIG. 7.

