



US00D399363S

United States Patent [19]

Natuzzi et al.

[11] Patent Number: **Des. 399,363**

[45] Date of Patent: ****Oct. 13, 1998**

[54] SEAT

[75] Inventors: **Pasquale Natuzzi; Raffaella Lucarelli**, both of Santeramo In Colle, Italy

[73] Assignee: **Industrie Natuzzi, Spa**, Santeramo, Italy

[**] Term: **14 Years**

[21] Appl. No.: **76,657**

[22] Filed: **Sep. 15, 1997**

[51] LOC (6) Cl. **06-01**

[52] U.S. Cl. **D6/381; D6/334**

[58] Field of Search D6/334, 335, 364, D6/371, 373, 381, 500, 501, 502; 297/232, 445.1

[56] References Cited

U.S. PATENT DOCUMENTS

D. 353,948	1/1995	Lowman	D6/381
D. 369,479	5/1996	Natuzzi et al.	D6/381
D. 373,484	9/1996	Natuzzi et al.	D6/381
D. 376,925	12/1996	Paus	D6/381
D. 383,619	9/1997	Culler	D6/381
D. 388,631	1/1998	Natuzzi et al.	D6/381
D. 388,970	1/1998	Natuzzi et al.	D6/381

OTHER PUBLICATIONS

Woodward & Lothrop, p. 30, Sofa at bottom right, Jan. 21, 1993.

Furniture Today, p. 31. Natuzzi Sofa 3rd down on right, Jun. 16, 1997.

Natuzzi Model 604/605, Oct. 1987, at International Home Furnishings Market in High Point, North Carolina.

Natuzzi Model 894, Apr. 1992, at International Home Furnishings Market in High Point, North Carolina.

Natuzzi Model 907, Apr. 1992, at International Home Furnishings Market in High Point, North Carolina.

Natuzzi Model 949, Oct., 1992, at International Home Furnishings Market in High Point, North Carolina.

Natuzzi Model 1140, Apr. 1994, at International Home Furnishings Market in High Point, North Carolina.

Natuzzi Model 1190, Apr. 1994, at International Home Furnishings Market in High Point, North Carolina.

Natuzzi Model 1204, Oct. 1994, at International Home Furnishings Market in High Point, North Carolina.

Natuzzi Model 1276, Mar. 1995, at International Home Furnishings Market in High Point, North Carolina.

Natuzzi Model 1349, Sep. 1995, at International Home Furnishings Market in High Point, North Carolina.

Natuzzi Model 1433, Mar. 1996, at International Home Furnishings Market in High Point, North Carolina.

Natuzzi Model 1436, Mar. 1996, at International Home Furnishings Market in High Point, North Carolina.

Natuzzi Model 1451, Mar. 1996, at International Home Furnishings Market in High Point, North Carolina.

Primary Examiner—Gary D. Watson

Attorney, Agent, or Firm—Bell Seltzer Intellectual Property Law Group of Alston & Bird LLP

[57] CLAIM

The ornamental design for a seat, as shown and described.

DESCRIPTION

FIG. 1 is a front perspective view of a seat showing our new design in the form of a sofa;

FIG. 2 is a front elevational view thereof;

FIG. 3 is a top plan view thereof;

FIG. 4 is a right side elevational view, the left side being a mirror image thereof;

FIG. 5 is a rear perspective view thereof;

FIG. 6 is a front elevational view of a seat showing our new design in the form of a loveseat; and,

FIG. 7 is a front elevational view of a seat showing our new design in the form of a chair.

The broken lines shown herein are for illustrative purposes only and form no part of the claimed design.

The rear views of FIGS. 6 and 7 are like FIG. 5, the difference being a matter of length.

The end views of FIGS. 6 and 7 are like that shown in FIG. 4.

FIGS. 1 and 5 are shown on an enlarged scale relative to the other views.

1 Claim, 3 Drawing Sheets

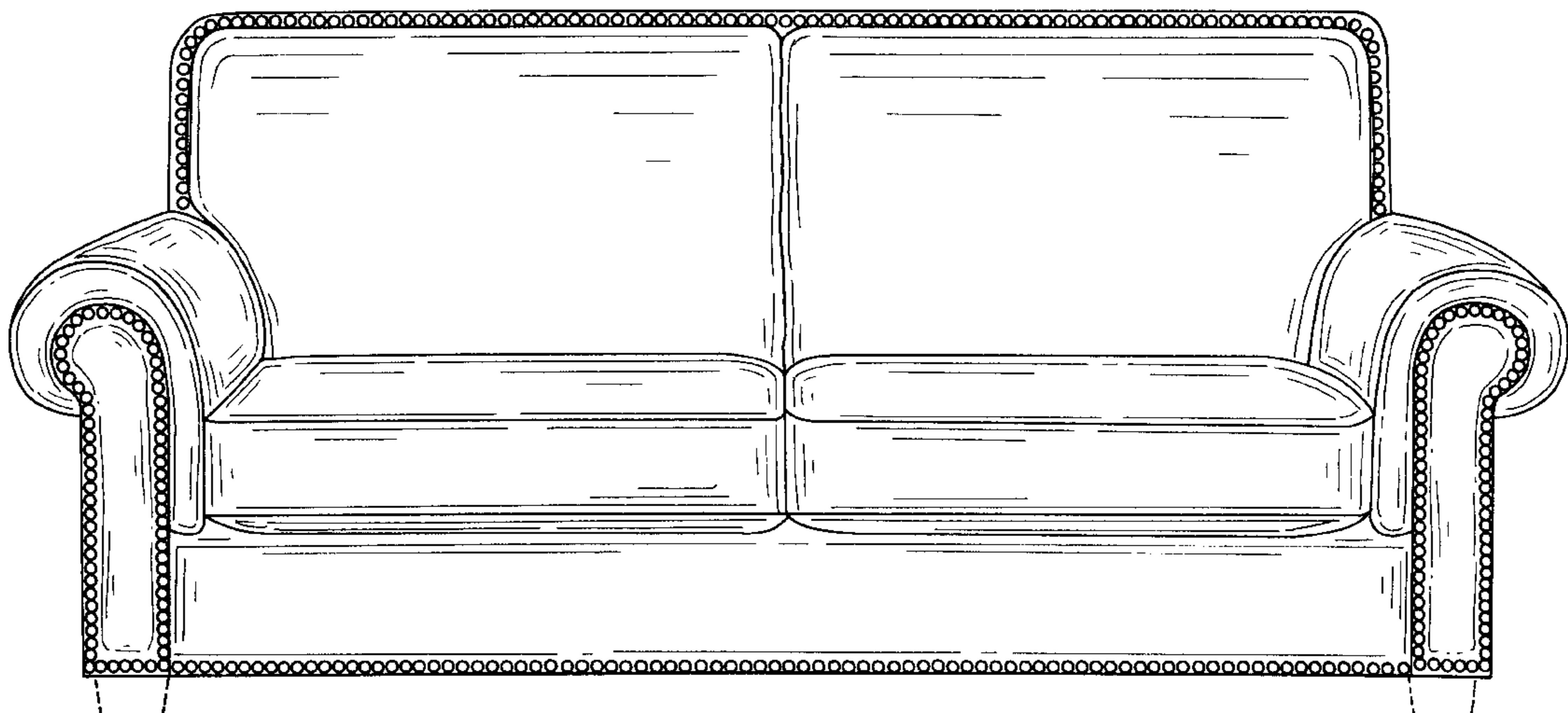

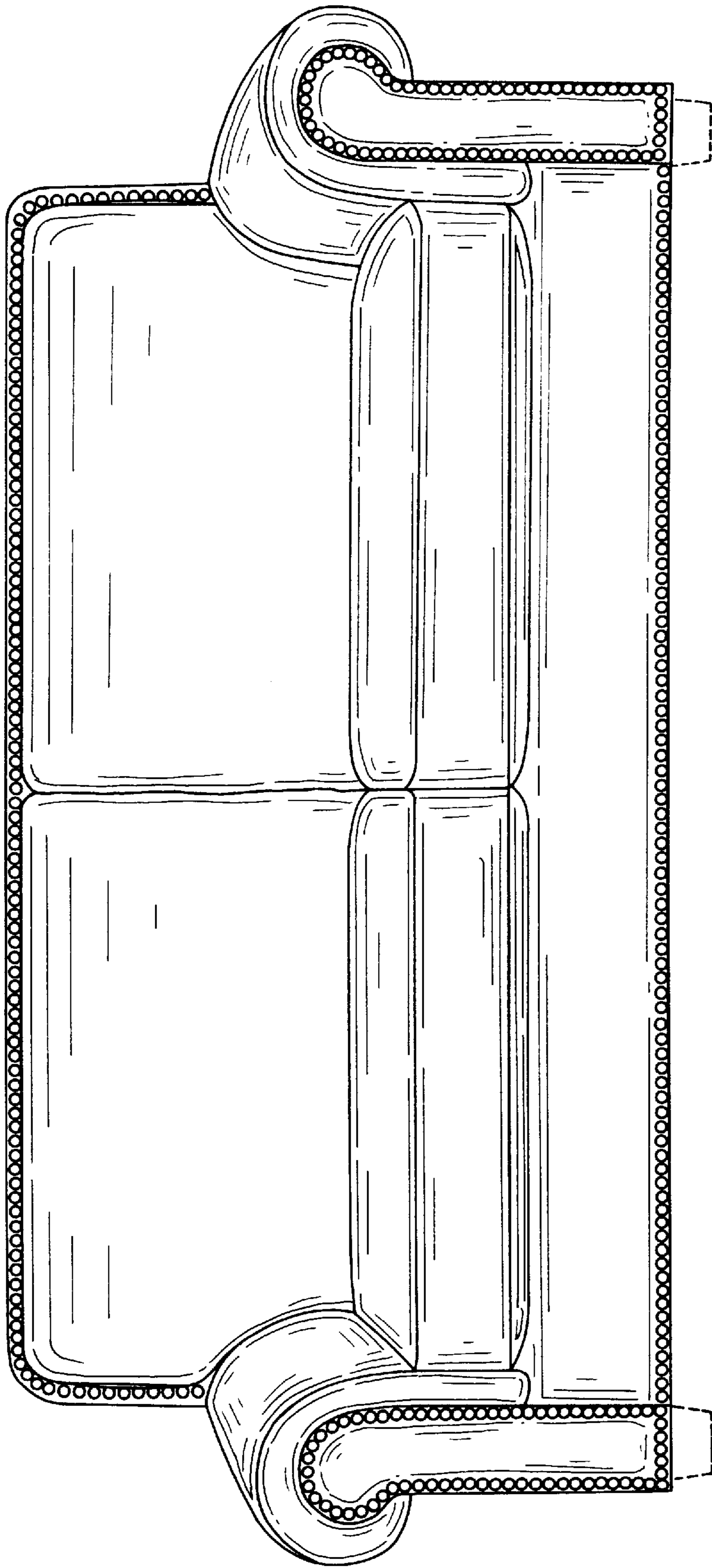

FIG. 1.

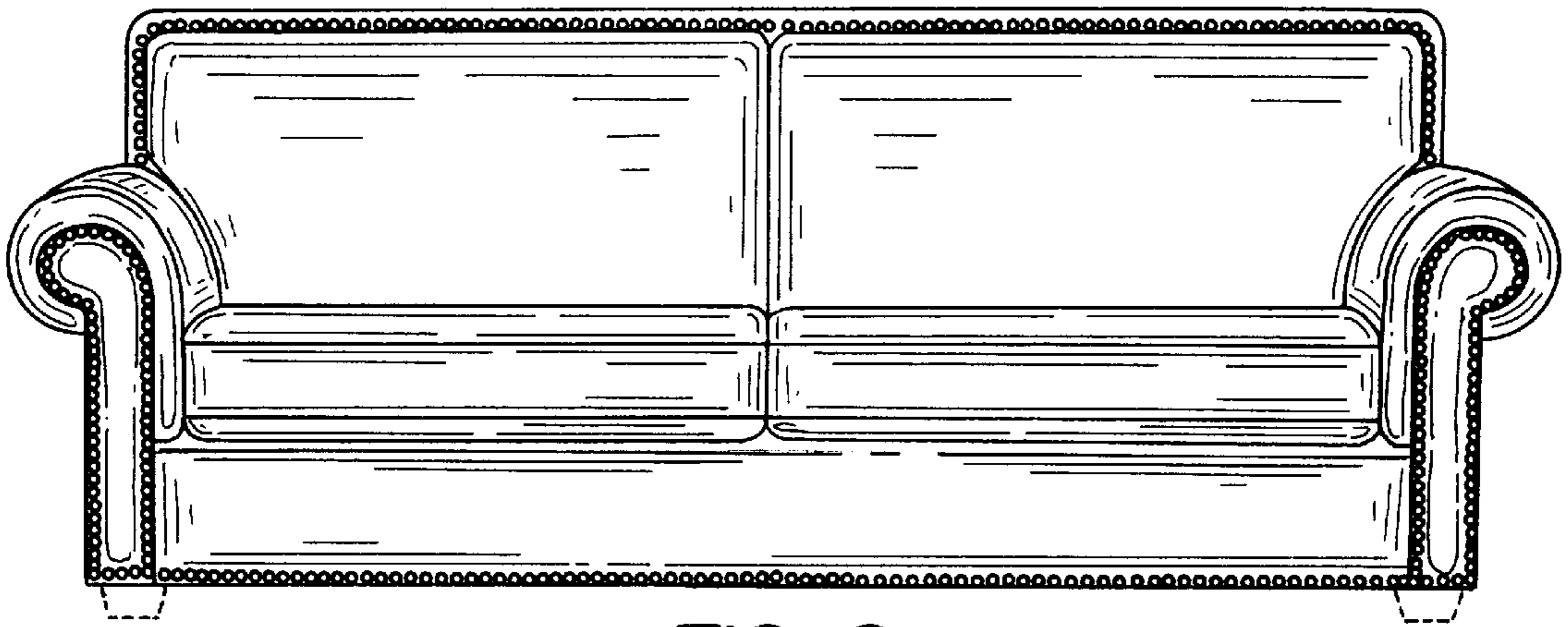

FIG. 2.

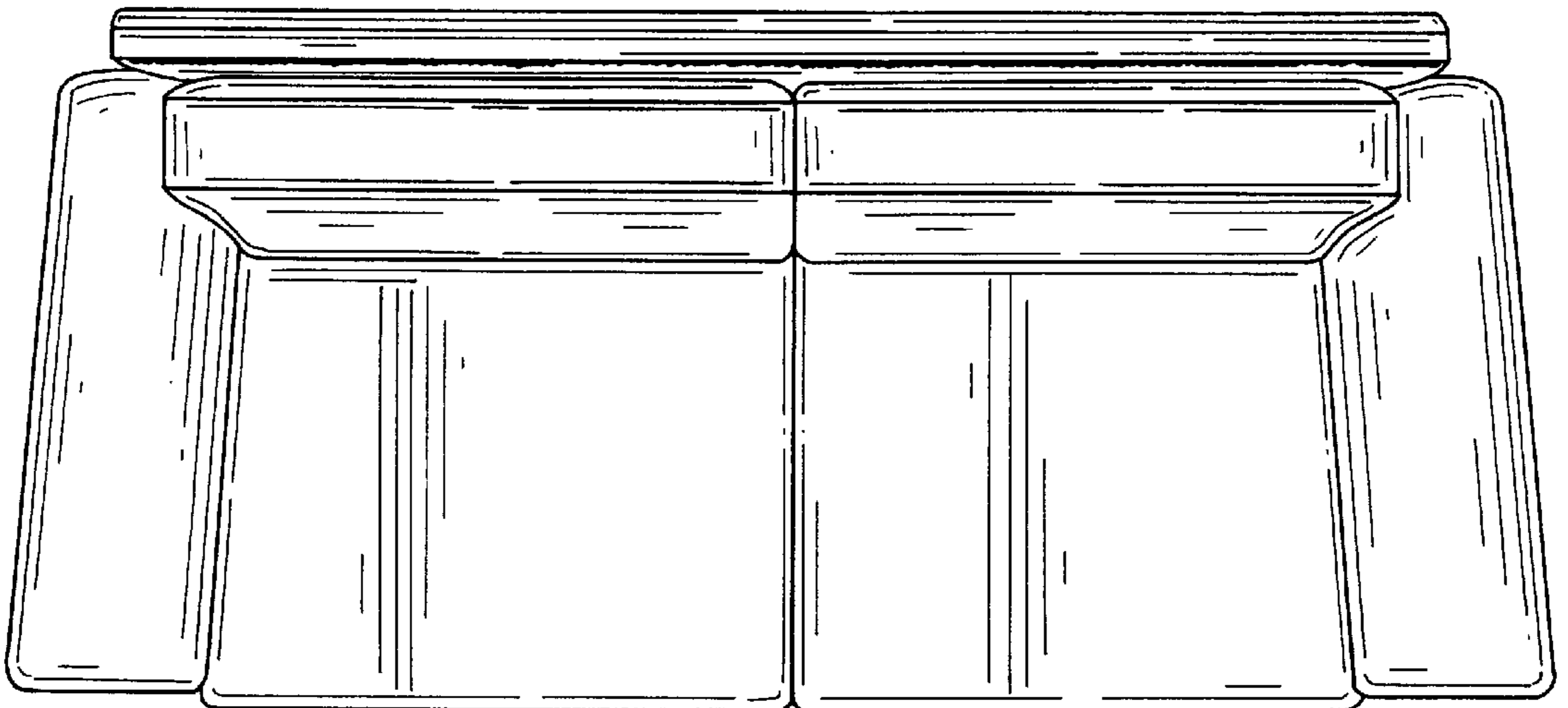

FIG. 3.

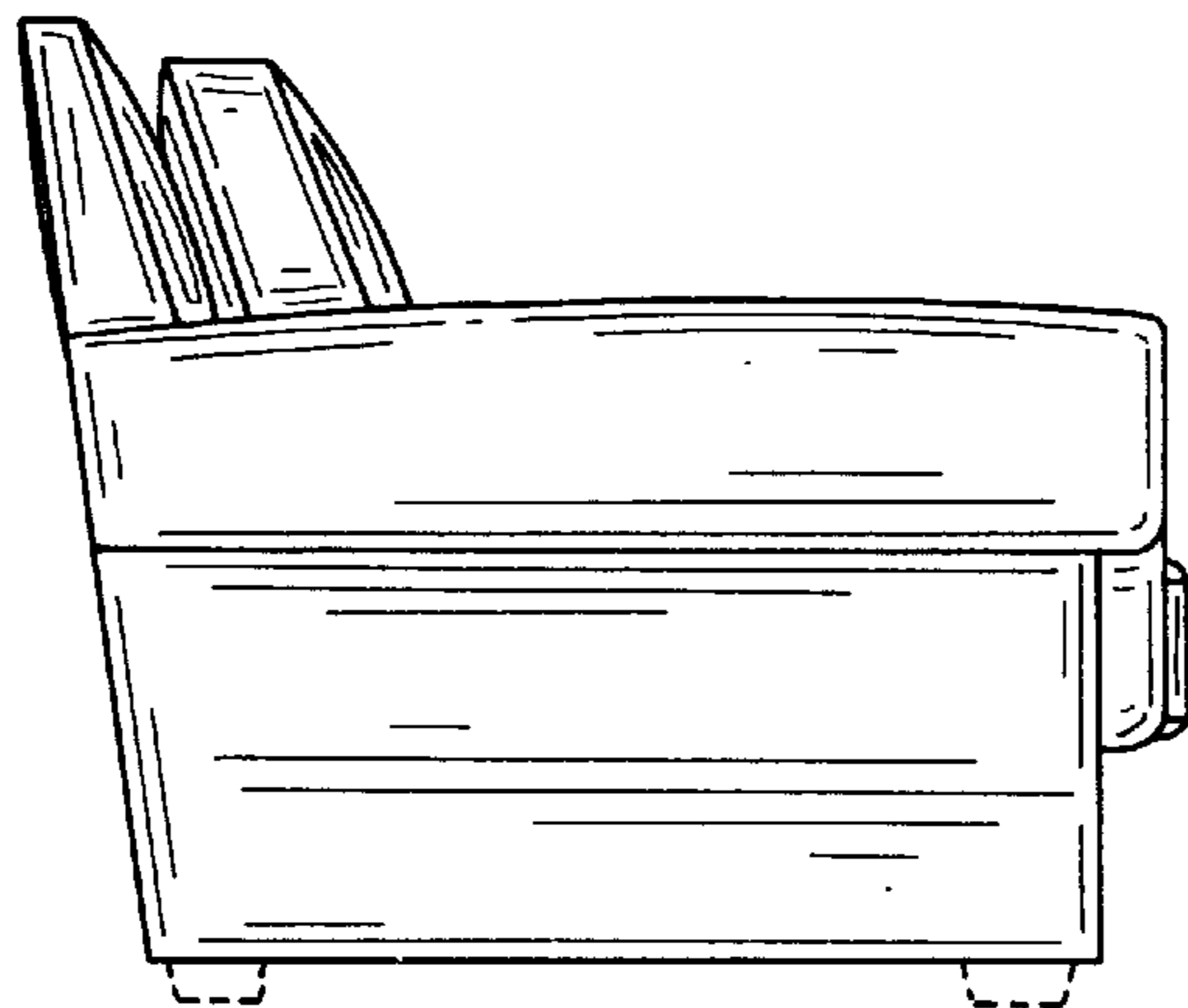

FIG. 4.

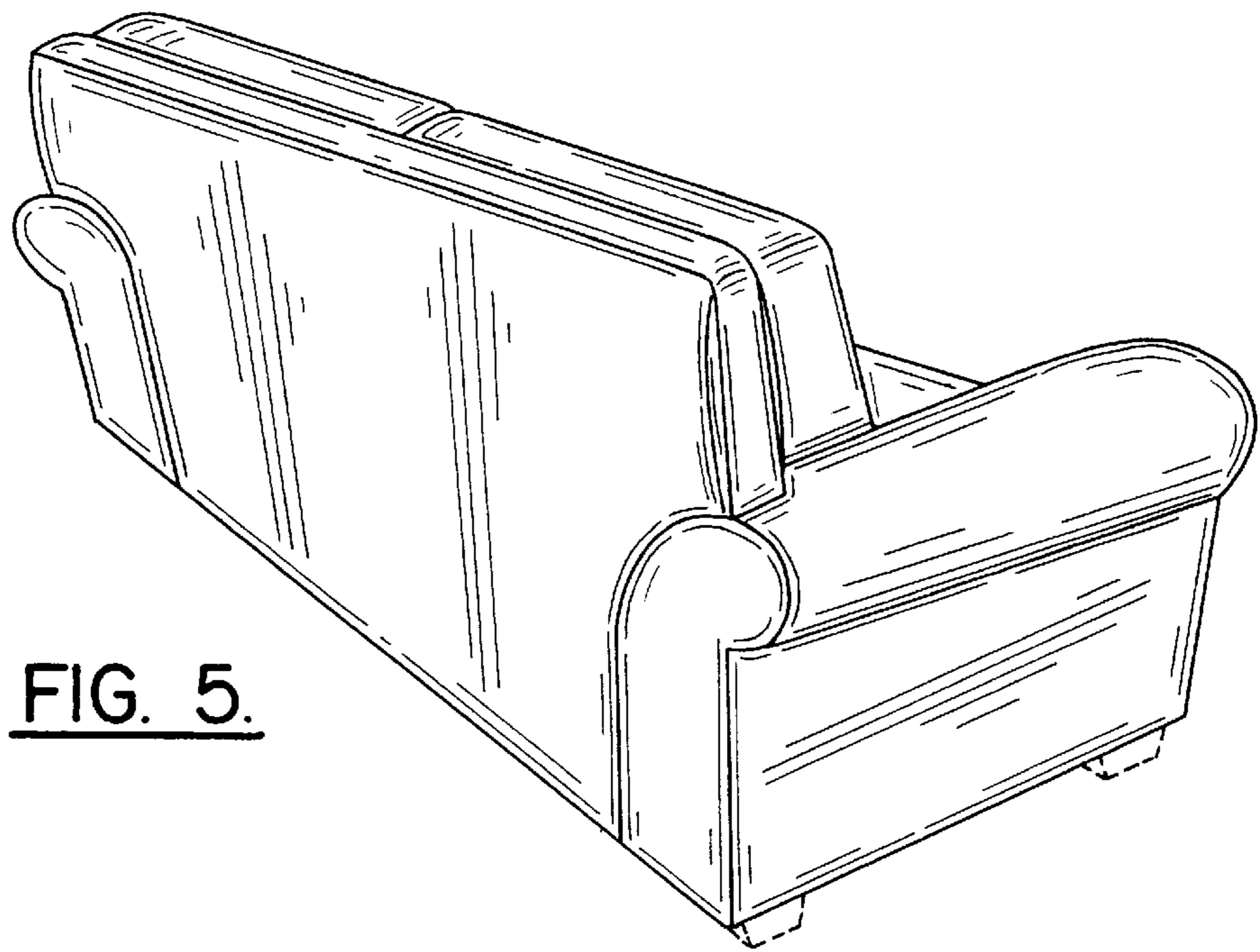

FIG. 5.

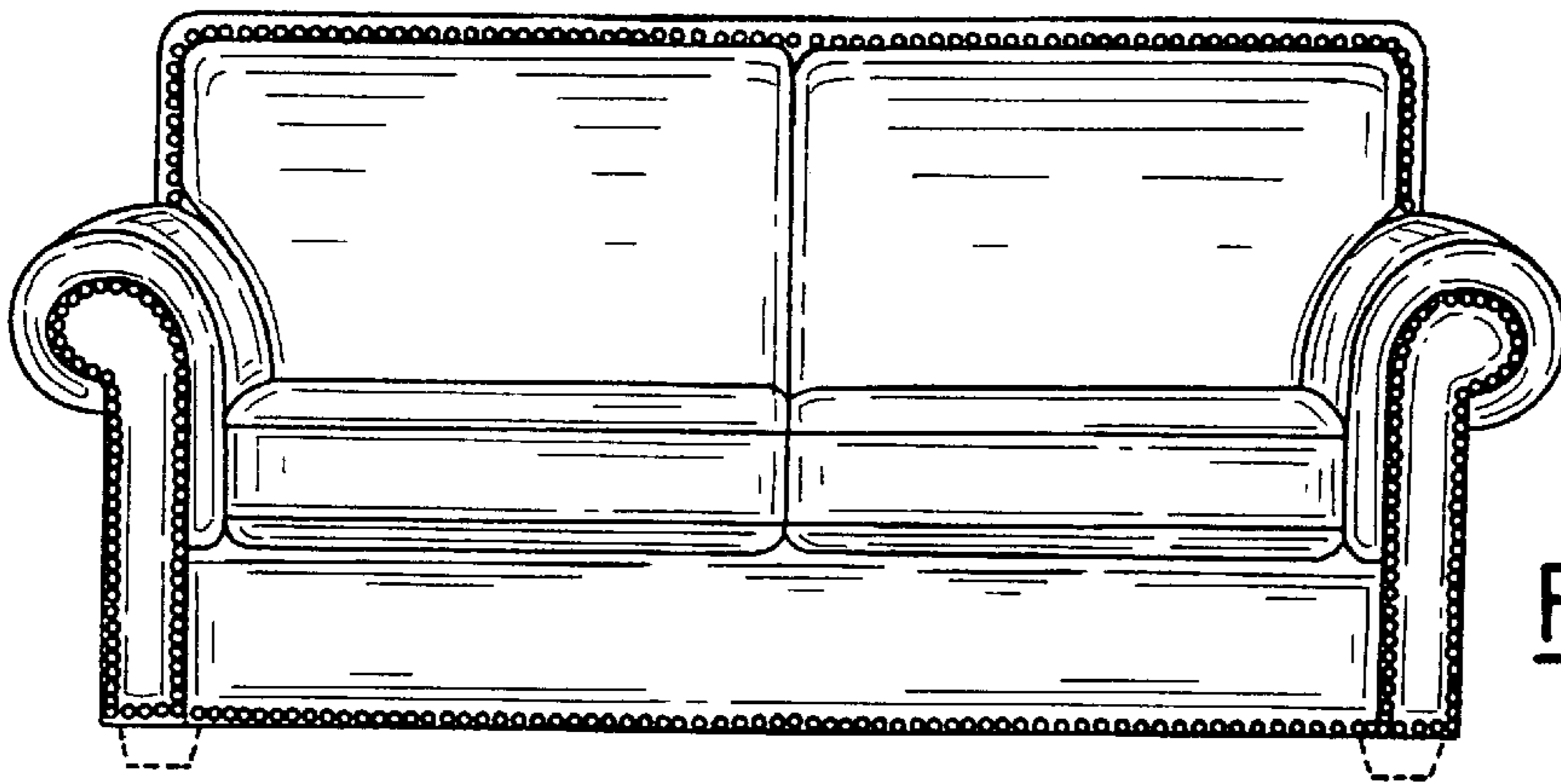

FIG. 6.

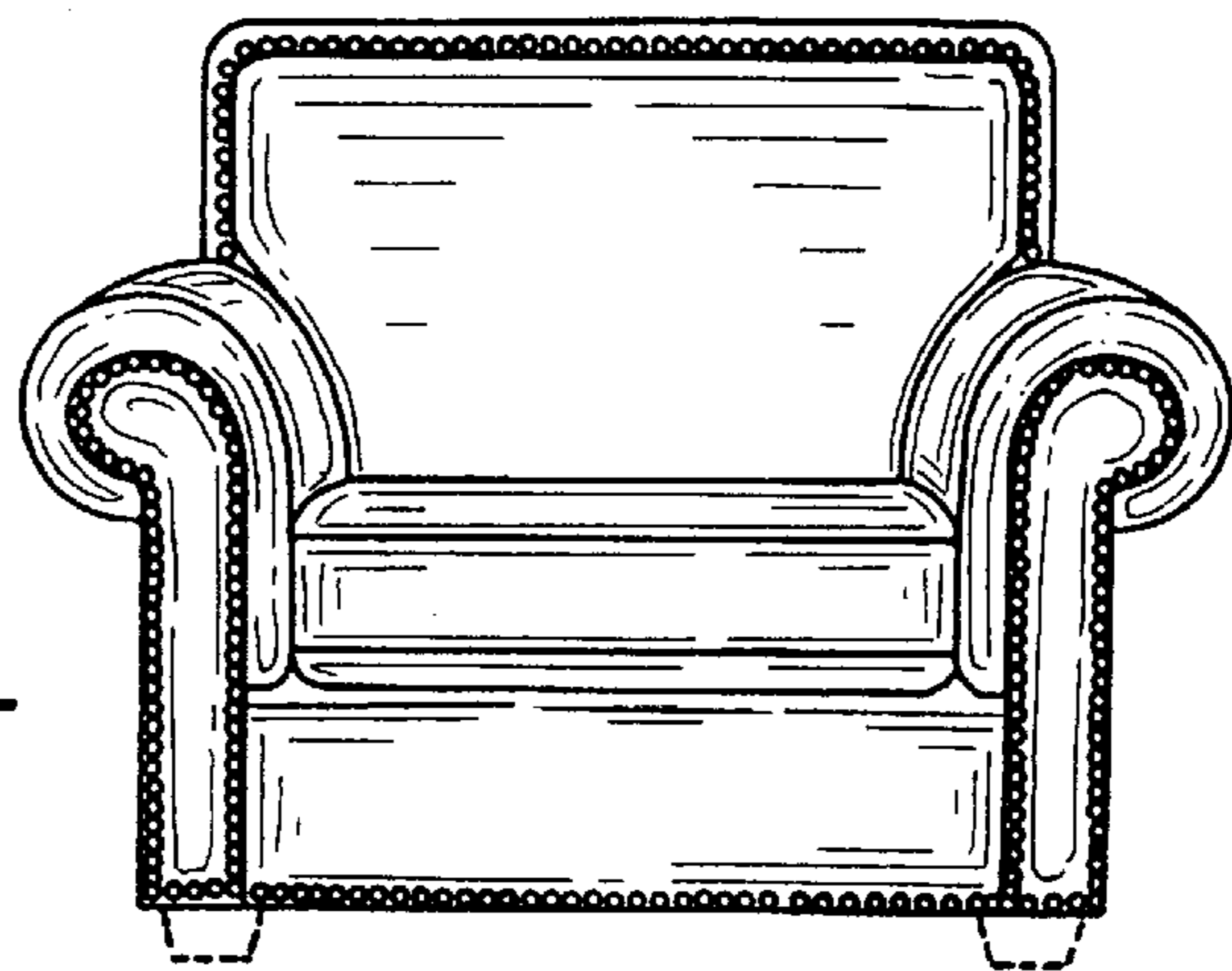

FIG. 7.