



US00D399361S

# United States Patent [19]

Natuzzi et al.

[11] Patent Number: **Des. 399,361**

[45] Date of Patent: **\*\*Oct. 13, 1998**

[54] SEAT

[75] Inventors: **Pasquale Natuzzi; Raffaella Lucarelli,**  
both of Santeramo In Colle, Italy

[73] Assignee: **Industrie Natuzzi, Spa,** Santeramo,  
Italy

[\*\*] Term: **14 Years**

[21] Appl. No.: **76,651**

[22] Filed: **Sep. 15, 1997**

[51] **LOC (6) Cl.** ..... **06-01**

[52] **U.S. Cl.** ..... **D6/381; D6/334**

[58] **Field of Search** ..... **D6/334, 335, 364,**  
**D6/371, 373, 381, 500, 501, 502; 297/232,**  
**445.1**

[56] **References Cited**

**U.S. PATENT DOCUMENTS**

D. 353,948	1/1995	Lowman	.....	D6/381
D. 367,180	2/1996	Natuzzi et al.	.....	D6/381
D. 369,479	5/1996	Natuzzi et al.	.....	D6/381
D. 373,484	9/1996	Natuzzi et al.	.....	D6/381
D. 383,619	9/1997	Cullen	.....	D6/381
D. 388,631	1/1998	Natuzzi et al.	.....	D6/381
D. 388,970	1/1998	Natuzzi et al.	.....	D6/381

**OTHER PUBLICATIONS**

Furniture/Today, p. 31, Natuzzi sofa second from bottom at right, Jun. 16, 1997.

Natuzzi Model 764, Apr. 1990, at International Home Furnishings Market in High Point, North Carolina.

Natuzzi Model 848, Apr. 1991, at International Home Furnishings Market in High Point, North Carolina.

Natuzzi Model 866, Oct. 1991, at International Home Furnishings Market in High Point, North Carolina.

Natuzzi Model 878, Oct. 1991, at International Home Furnishings Market in High Point, North Carolina.

Natuzzi Model 897, Apr. 1992, at International Home Furnishings Market in High Point, North Carolina.

Natuzzi Model 1059, Apr. 1993, at International Home Furnishings Market in High Point, North Carolina.

Natuzzi Model 1068, Oct. 1993, at International Home Furnishings Market in High Point, North Carolina.

Natuzzi Model 1114, Oct. 1993, at International Home Furnishings Market in High Point, North Carolina.

Natuzzi Model 1142, Apr. 1994, at International Home Furnishings Market in High Point, North Carolina.

Natuzzi Model 1183, Apr. 1993, at International Home Furnishings Market in High Point, North Carolina.

Natuzzi Model 1201, Oct. 1994, at International Home Furnishings Market in High Point, North Carolina.

Natuzzi Model 1293, Mar. 1995, at International Home Furnishings Market in High Point, North Carolina.

Natuzzi Model 1349, Sep. 1995, at International Home Furnishings Market in High Point, North Carolina.

Natuzzi Model 1425, Mar. 1996, at International Home Furnishings Market in High Point, North Carolina.

Natuzzi Model 1441, Mar. 1996, at International Home Furnishings Market in High Point, North Carolina.

Natuzzi Model 1450, Mar. 1996, at International Home Furnishings Market in High Point, North Carolina.

*Primary Examiner*—Gary D. Watson

*Attorney, Agent, or Firm*—Bell Seltzer Intellectual Property Law Group of Alston & Bird LLP

[57] **CLAIM**

The ornamental design for a seat, as shown and described.

**DESCRIPTION**

FIG. 1 is a front perspective view of a seat showing our new design in the form of a sofa;

FIG. 2 is a front elevational view thereof;

FIG. 3 is a top plan view thereof;

FIG. 4 is a right side elevational view, the left side being a mirror image thereof;

FIG. 5 is a rear perspective view thereof;

FIG. 6 is a front elevational view of a seat showing our new design in the form of a loveseat; and,

FIG. 7 is a front elevational view of a seat showing our new design in the form of a chair.

The broken lines shown herein are for illustrative purposes only and form no part of the claimed design.

The rear views of FIGS. 6 and 7 are like FIG. 5, the difference being a matter of length.

The end views of FIGS. 6 and 7 are like that shown in FIG. 4.

FIGS. 1 and 5 are shown on an enlarged scale relative to the other views.

**1 Claim, 3 Drawing Sheets**

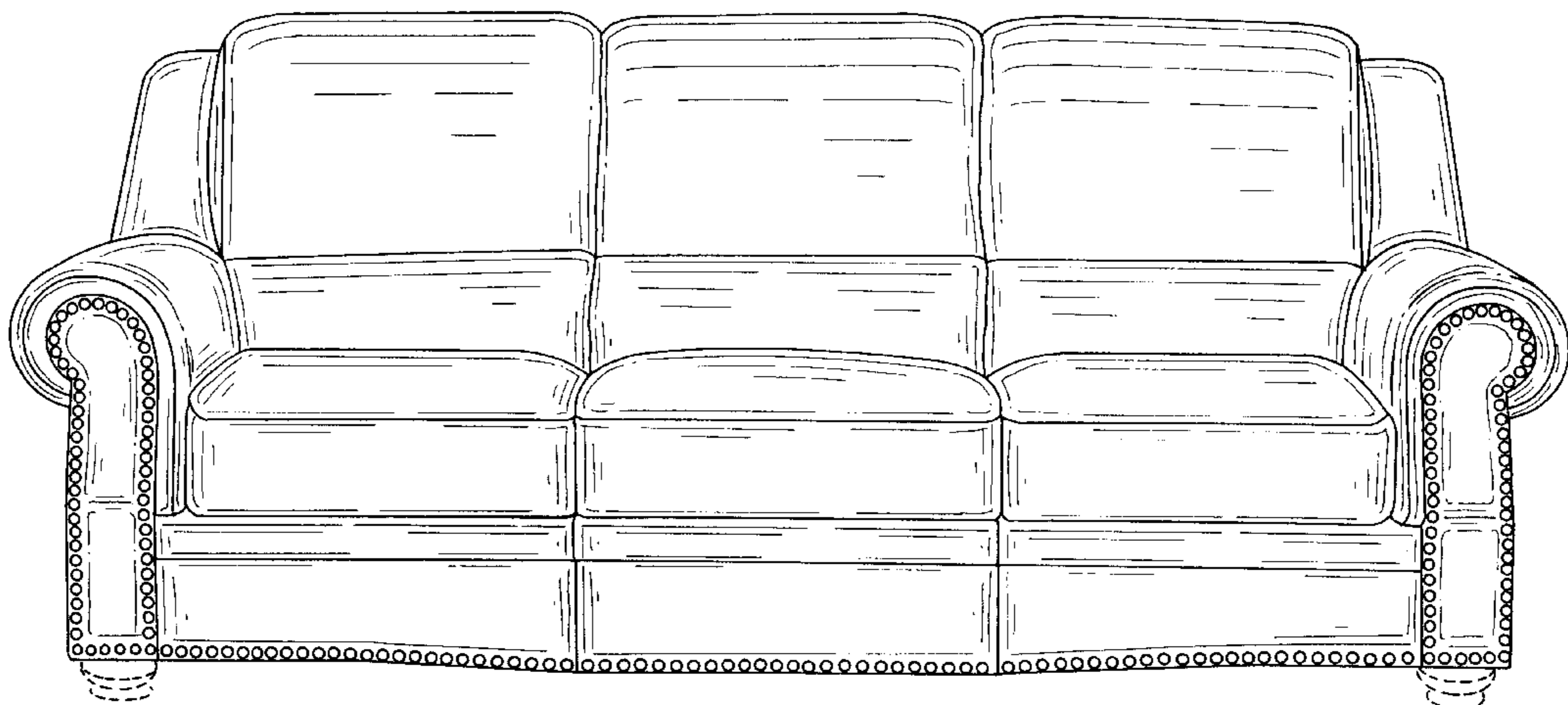

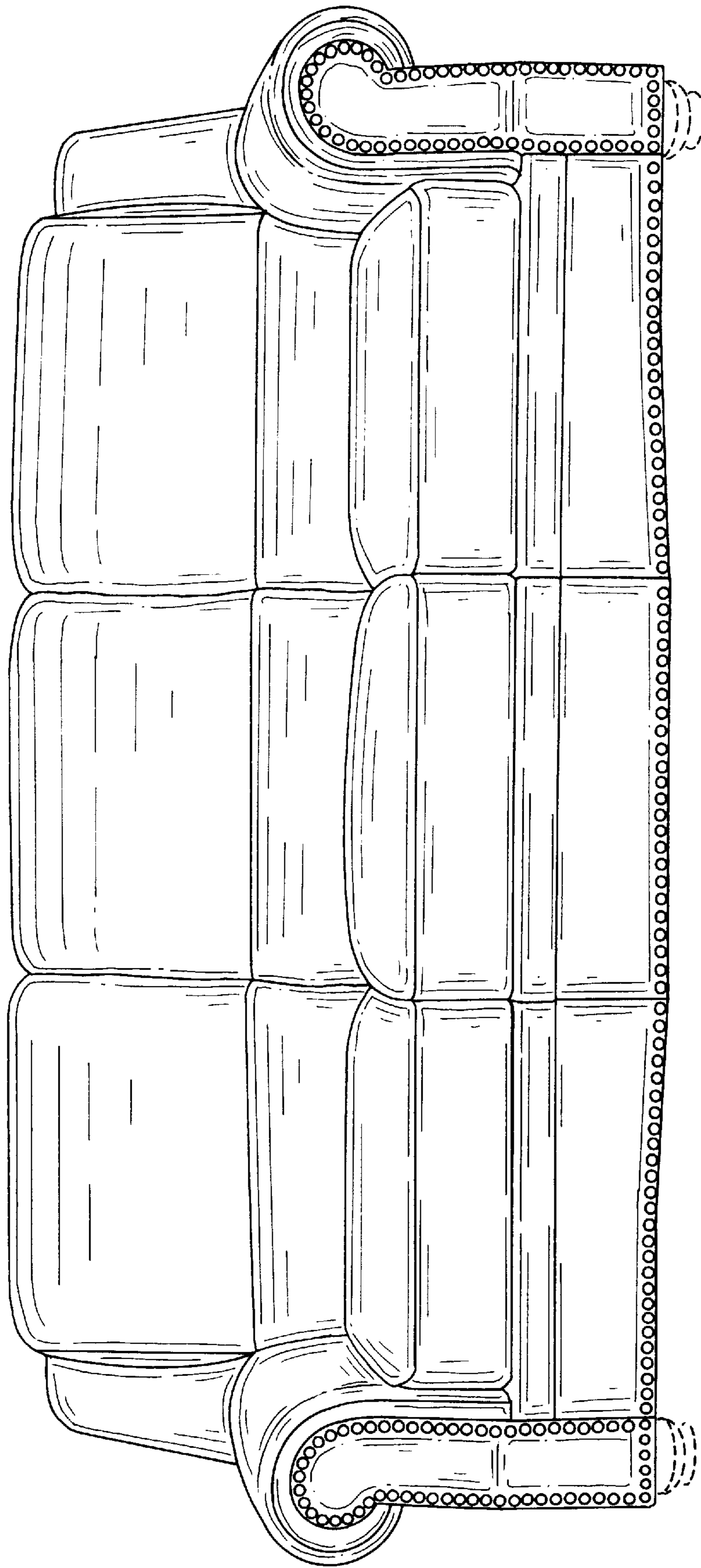

FIG. 1.

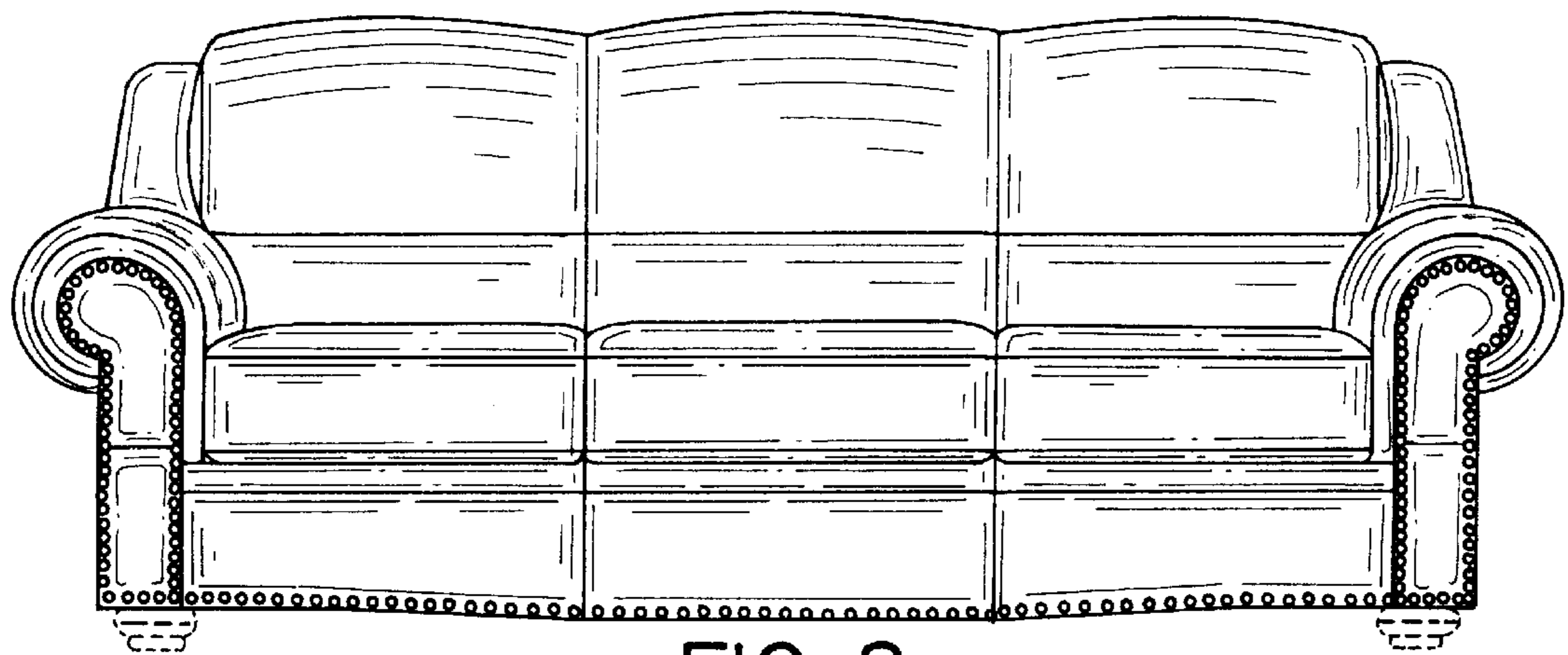

FIG. 2.

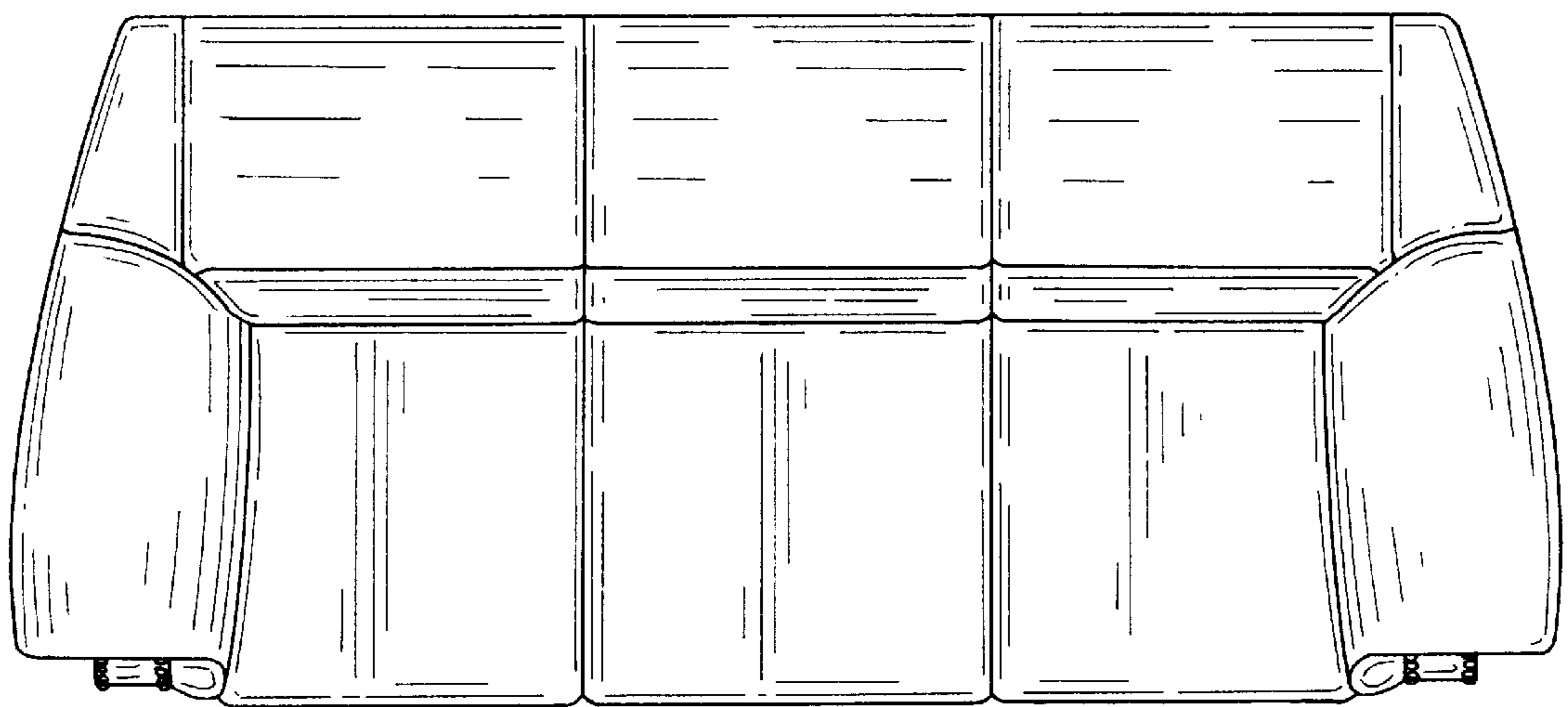

FIG. 3.

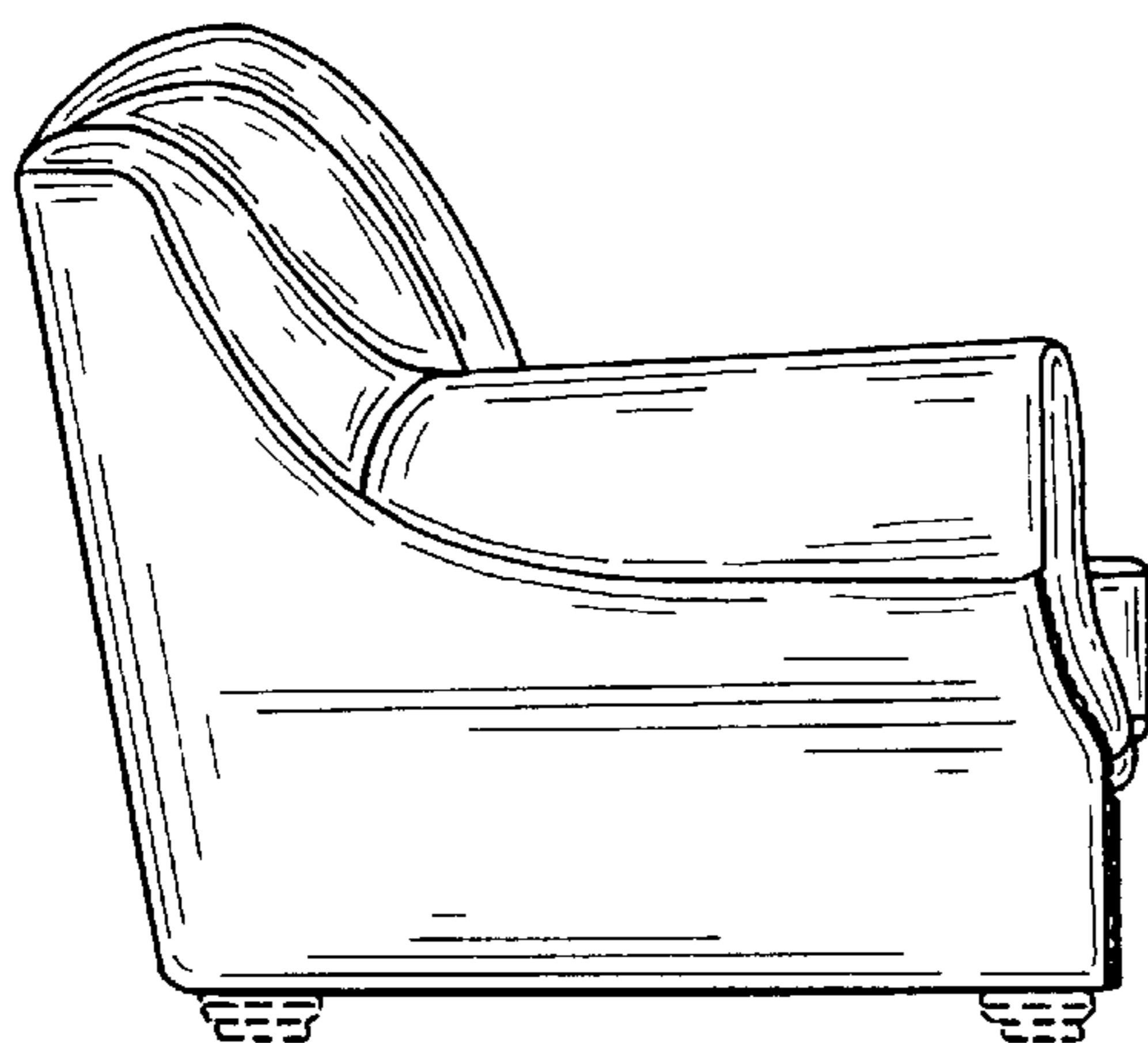

FIG. 4.

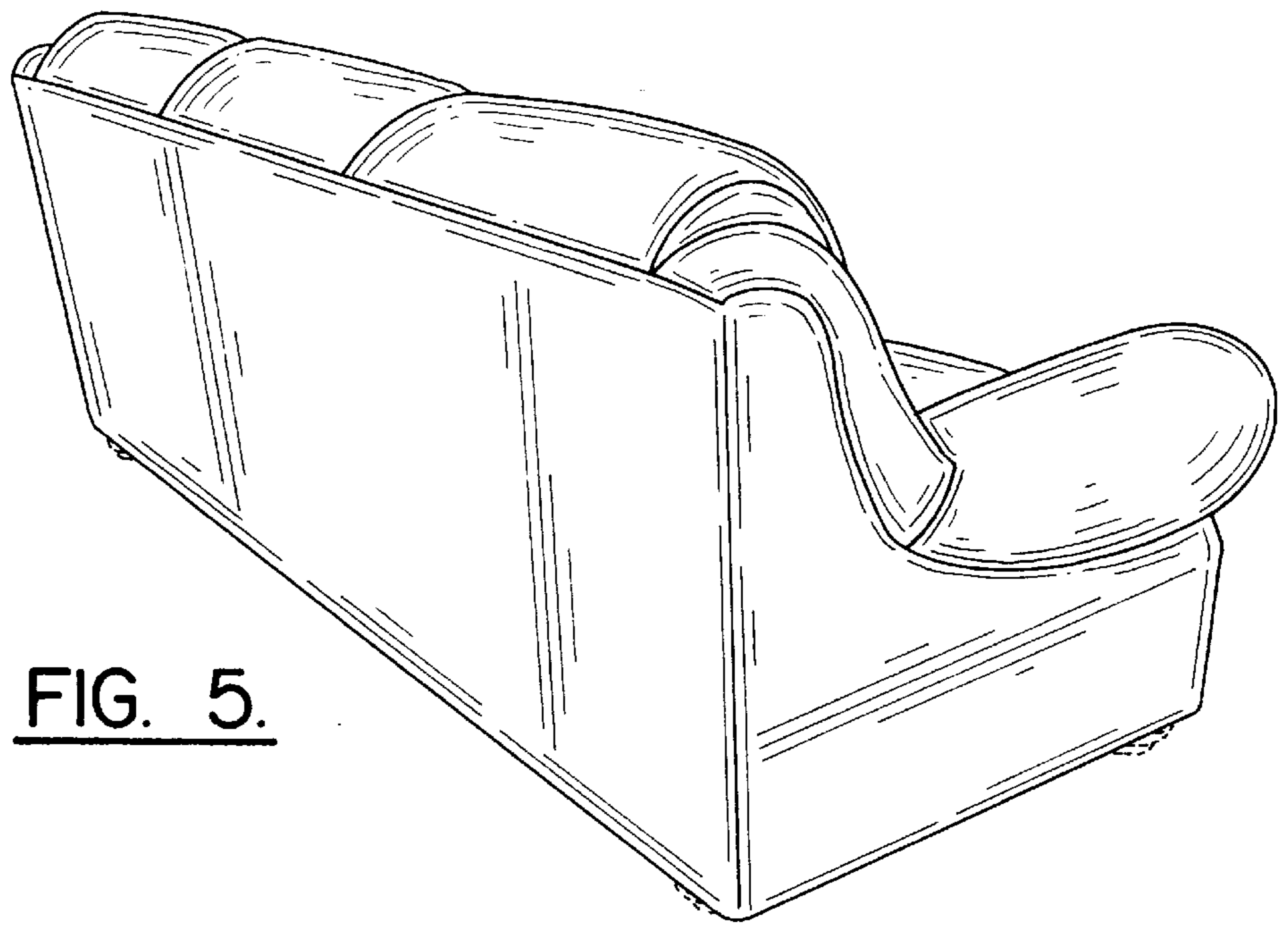

FIG. 5.

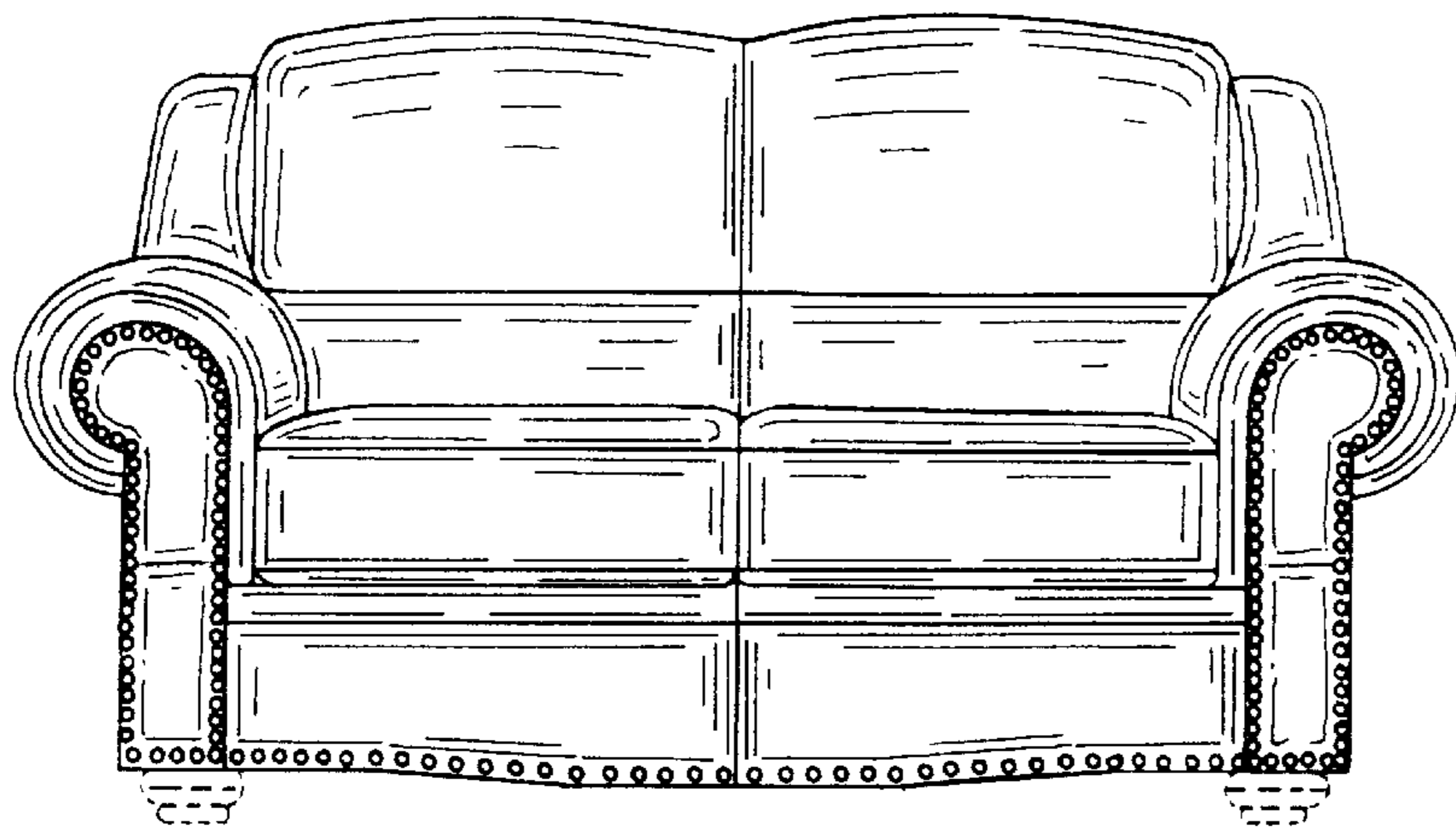

FIG. 6.

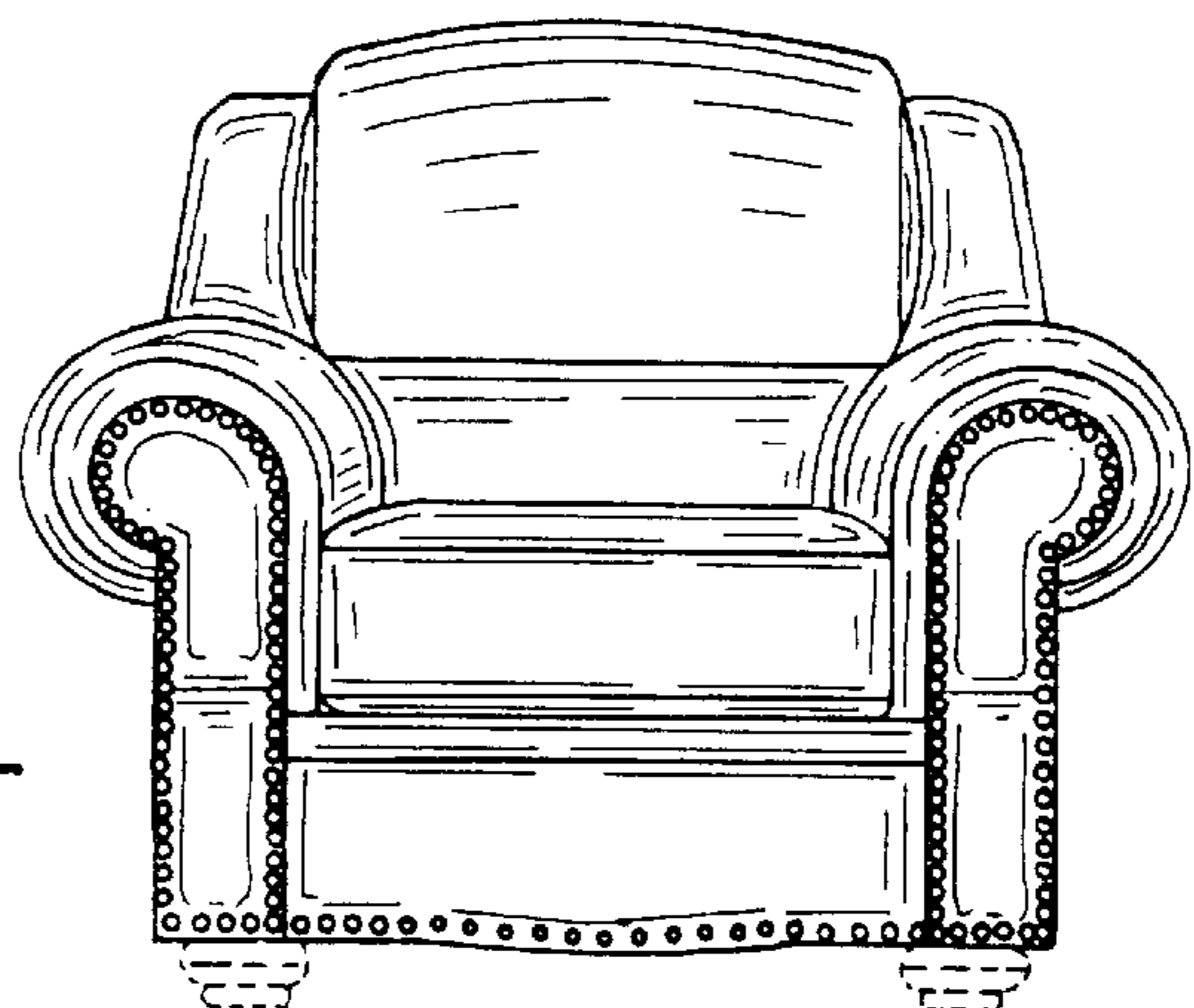

FIG. 7.