



US00D399349S

United States Patent [19]

Barth

[11] **Patent Number: Des. 399,349**

[45] **Date of Patent: **Oct. 13, 1998**

[54] **TOOTH BRUSH TO CLEANSE MOUTH AS WELL AS TEETH**

4,328,604 5/1982 Adams 15/110
5,564,150 10/1996 Ciccotelli 15/167.1

[76] Inventor: **Steven T. Barth**, 260 Ramona Ave., Salt Lake City, Utah 84115

Primary Examiner—Alan P. Douglas
Assistant Examiner—Lavone D. Tabor
Attorney, Agent, or Firm—K. S. Cornaby

[**] Term: **14 Years**

[57] **CLAIM**

[21] Appl. No.: **83,688**

The ornamental design for a tooth brush to cleanse mouth as well as teeth, as shown.

[22] Filed: **Feb. 17, 1998**

[51] **LOC (6) Cl. 04-02**

DESCRIPTION

[52] **U.S. Cl. D4/106; D4/133**

FIG. 1 is a perspective view taken from the top, front and right side of an showing our new design;
FIG. 2 is a top plan view thereof;
FIG. 3 is a bottom plan view thereof;
FIG. 4 is a right side elevational view thereof;
FIG. 5 is a left side elevational view thereof;
FIG. 6 is a rear elevational view thereof; and,
FIG. 7 is a front elevational view thereof.

[58] **Field of Search** D4/104-112, 119, D4/120, 133, 134, 138; 15/106, 110, 143.1, 159.1, 167.1, 167.2; 601/139, 141

[56] **References Cited**

U.S. PATENT DOCUMENTS

D. 46,650 11/1914 Lavenson D4/106
D. 75,971 8/1928 Faubert et al. D4/106
D. 357,586 4/1995 Tubman D4/133

1 Claim, 2 Drawing Sheets

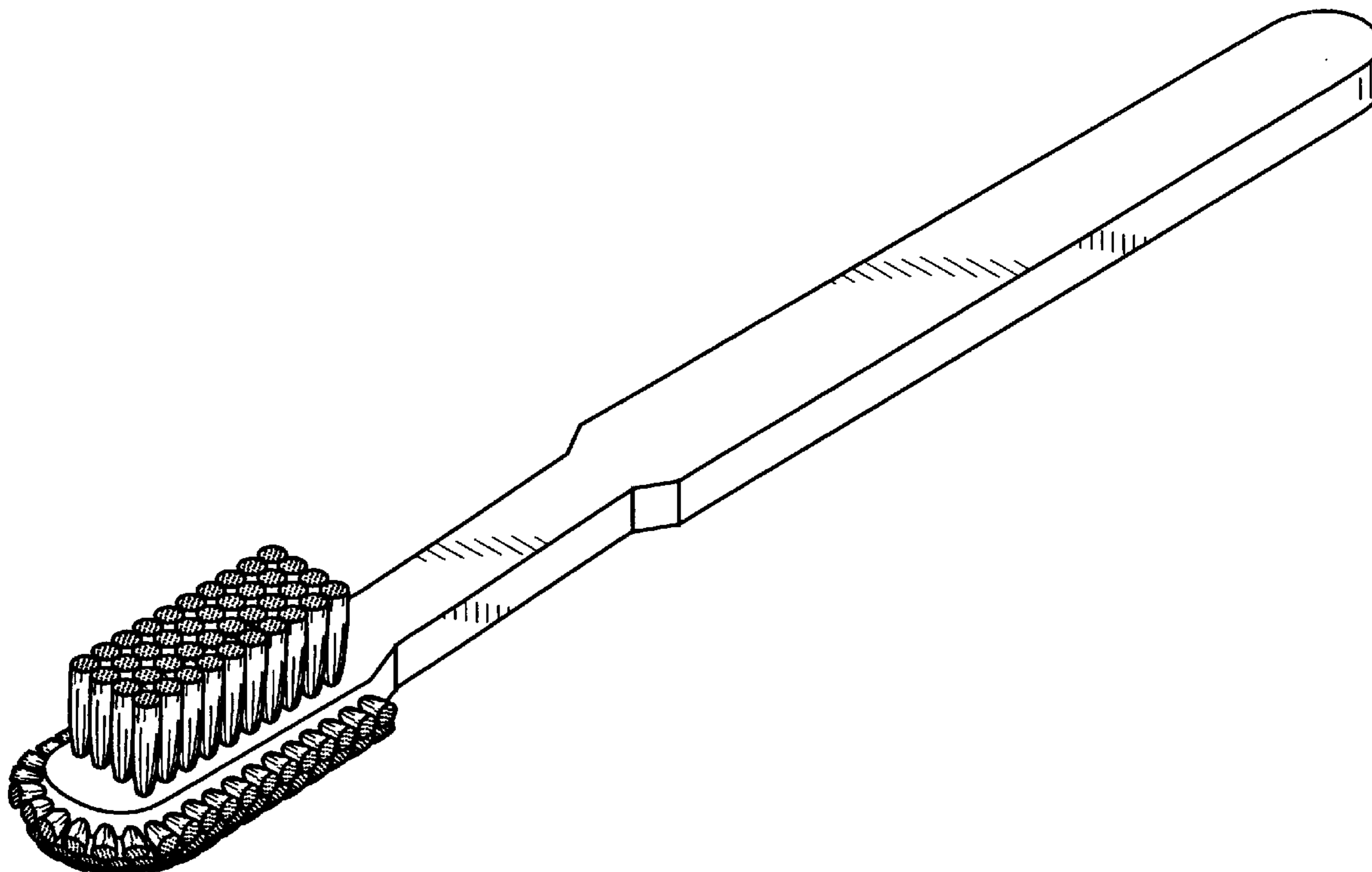

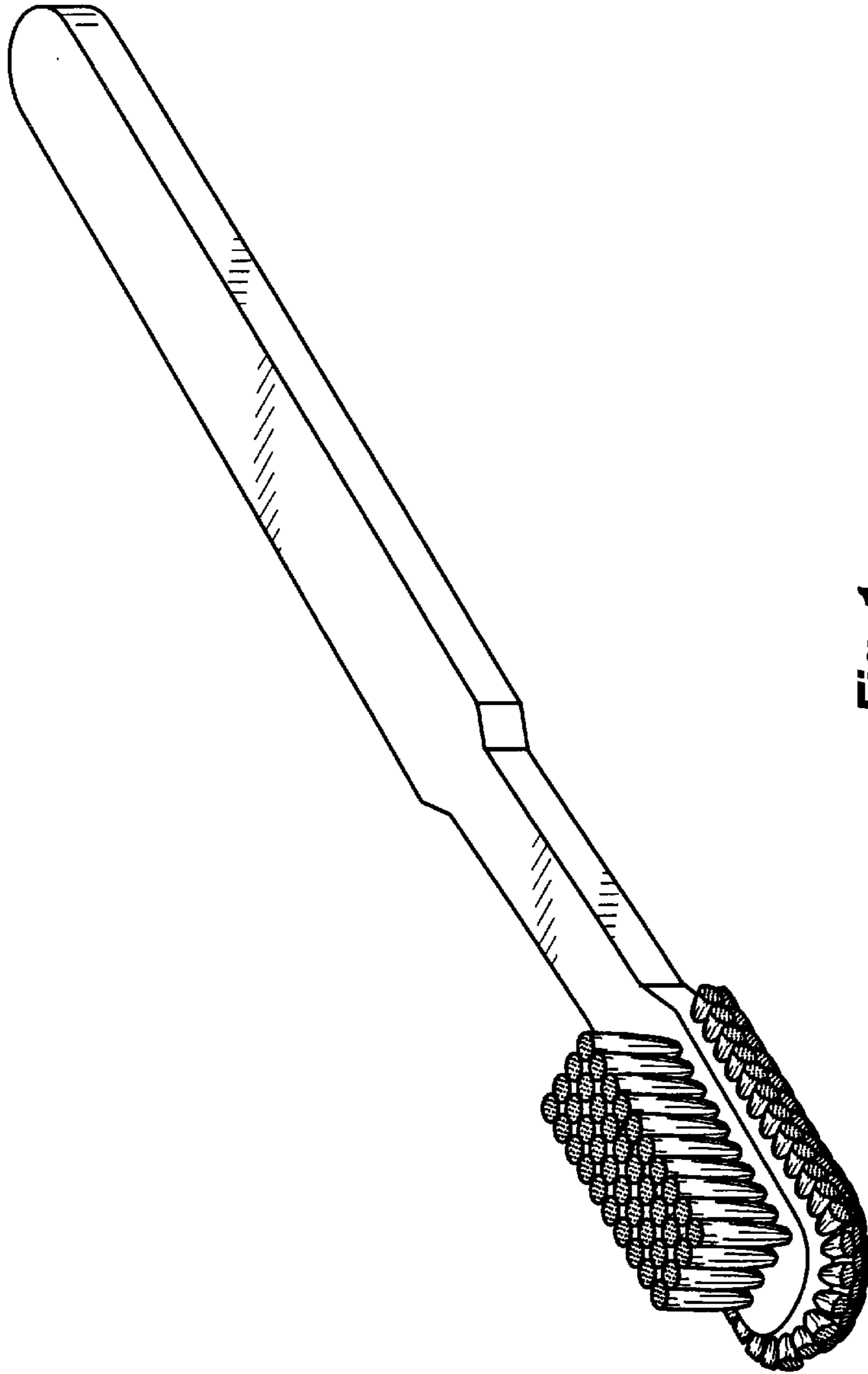

Fig. 1

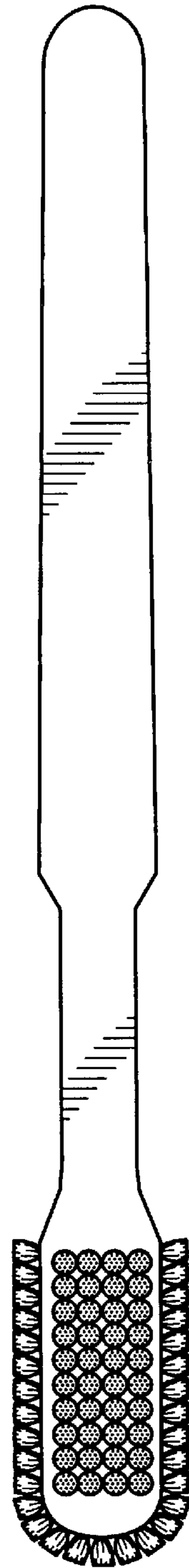

Fig. 2

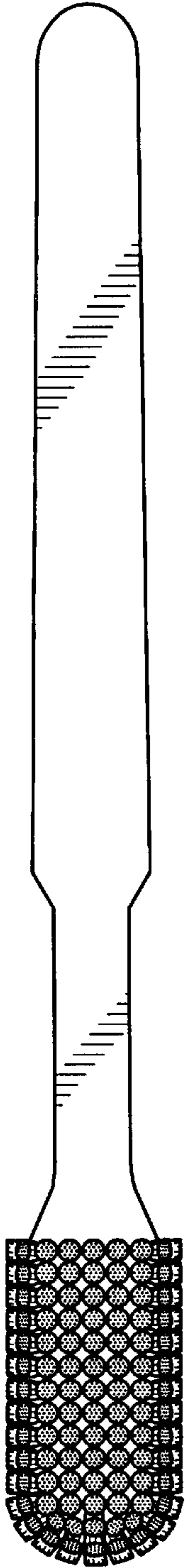

Fig. 3

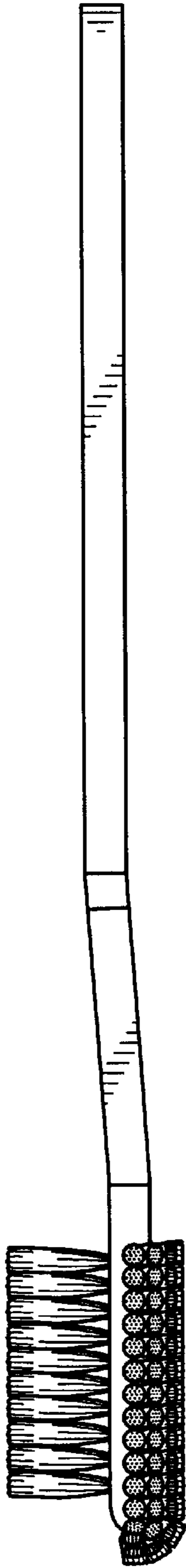

Fig. 4

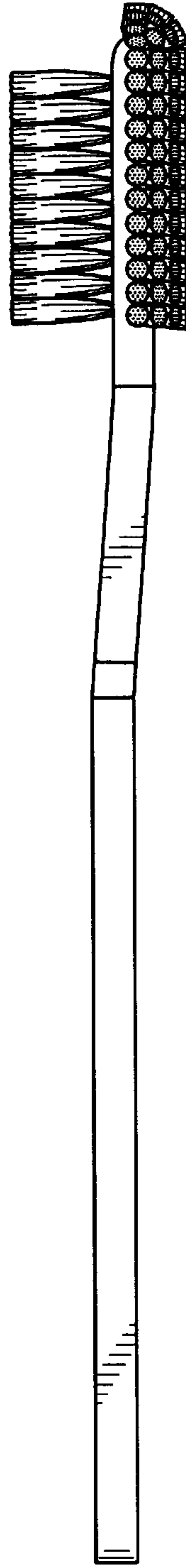

Fig. 5

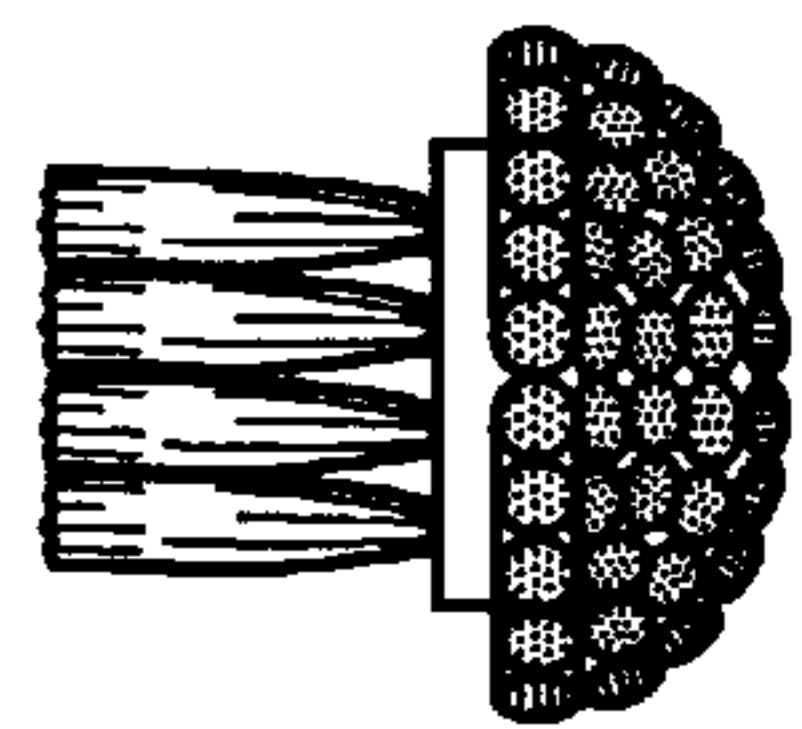

Fig. 6

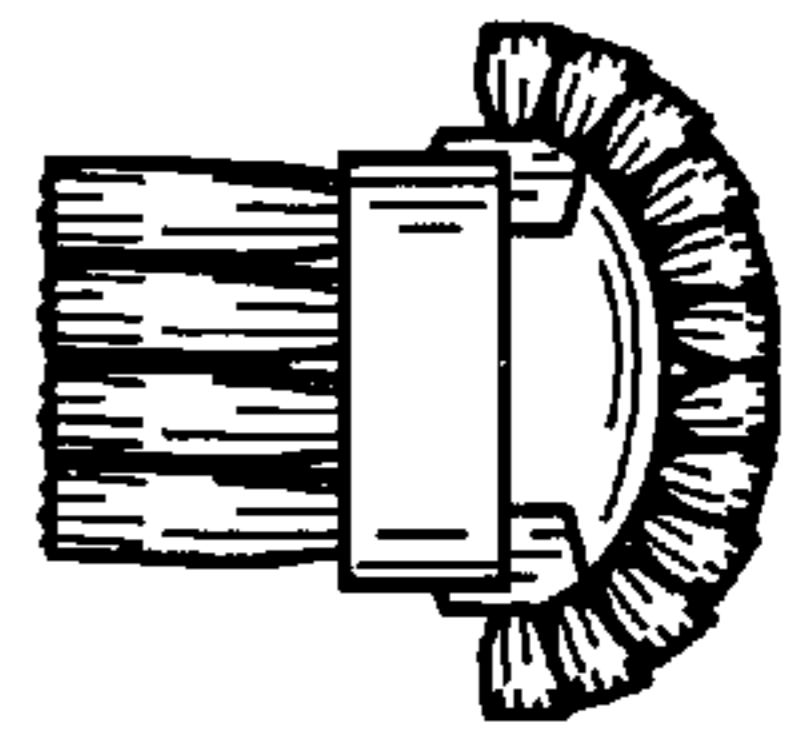

Fig. 7