



US00D399328S

United States Patent [19] Compton

[11] **Patent Number: Des. 399,328**

[45] **Date of Patent: **Oct. 6, 1998**

[54] **LUMINAIRE**

D. 360,047 7/1995 Zimmerman et al. D26/87 X
4,319,312 3/1982 De Vos et al. 362/431 X

[75] Inventor: **Wayne W. Compton**, Chino Hills, Calif.

Primary Examiner—Susan J. Lucas
Attorney, Agent, or Firm—Lyon & Lyon LLP

[73] Assignee: **Kim Lighting, Inc.**, City of Industry, Calif.

[**] Term: **14 Years**

[57] **CLAIM**

The ornamental design for a luminaire, as shown and described.

[21] Appl. No.: **74,236**

[22] Filed: **Jul. 29, 1997**

DESCRIPTION

Related U.S. Application Data

FIG. 1 is a front elevational view, the rear being a mirror image;

[62] Division of Ser. No. 43,756, Sep. 8, 1995, Pat. No. Des. 389,262.

FIG. 2 is a top plan view;

[51] **LOC (6) Cl.** **26-05**

FIG. 3 is a side elevational view, the opposite side being a mirror image;

[52] **U.S. Cl.** **D26/72; D26/67; D26/87**

FIG. 4 is a bottom plan view thereof; and,

[58] **Field of Search** **D26/72, 80-92, D26/67, 68, 69, 70, 71; 362/147, 431, 432**

FIG. 5 is a fragmentary front perspective view of the luminaire, the luminaire being fragmentarily shown for convenience of illustration.

[56] **References Cited**

U.S. PATENT DOCUMENTS

D. 358,902 5/1995 Webster, III D26/87

1 Claim, 2 Drawing Sheets

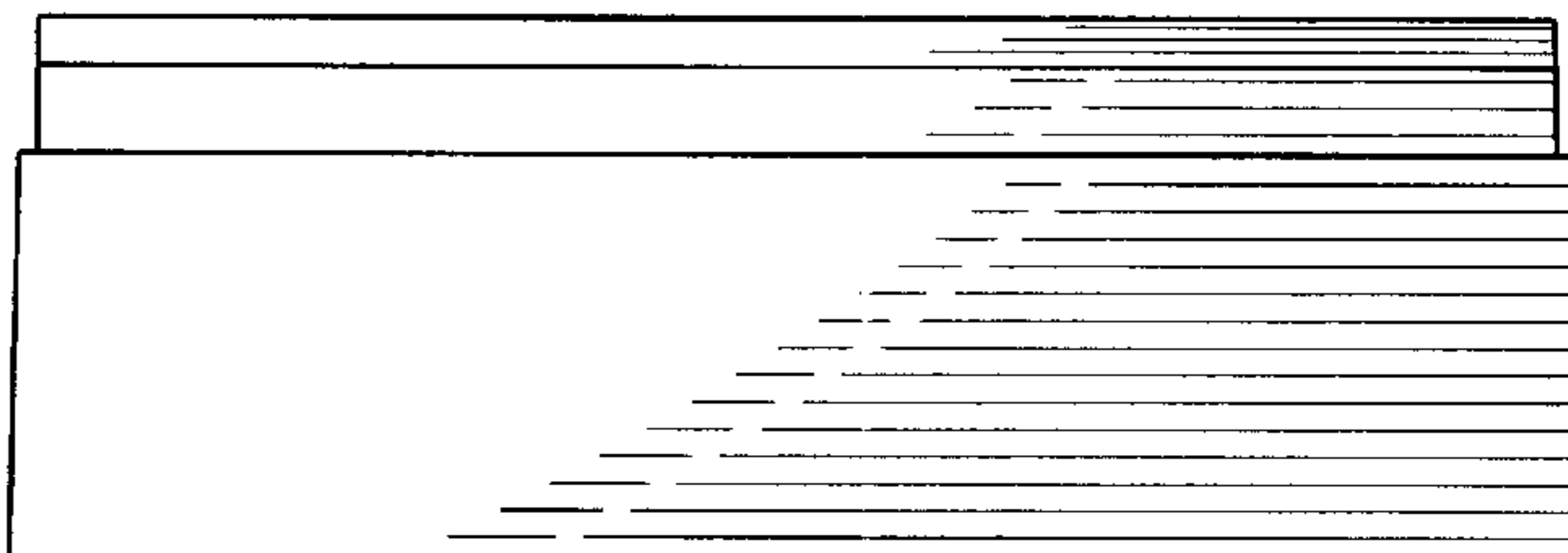
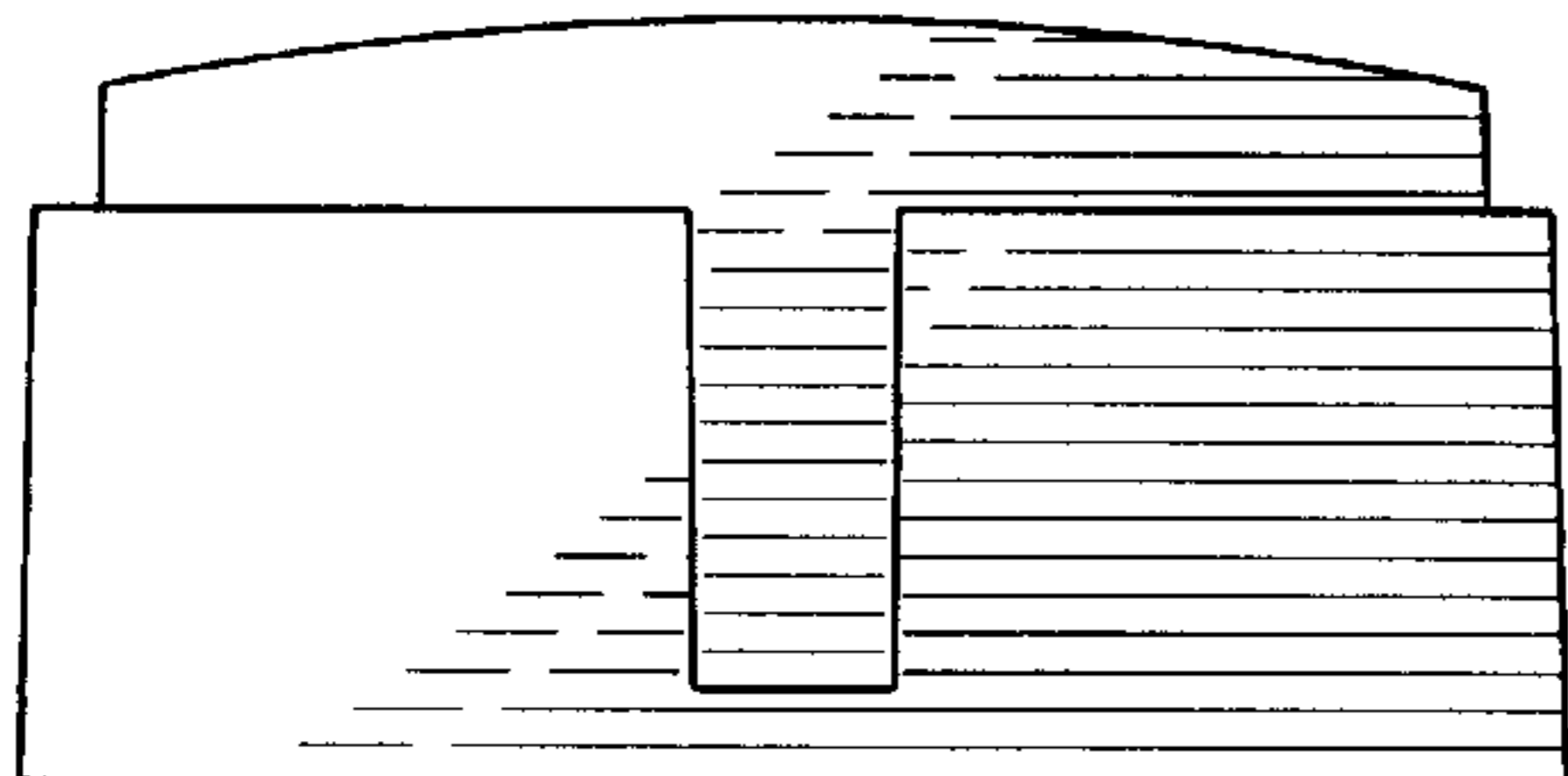

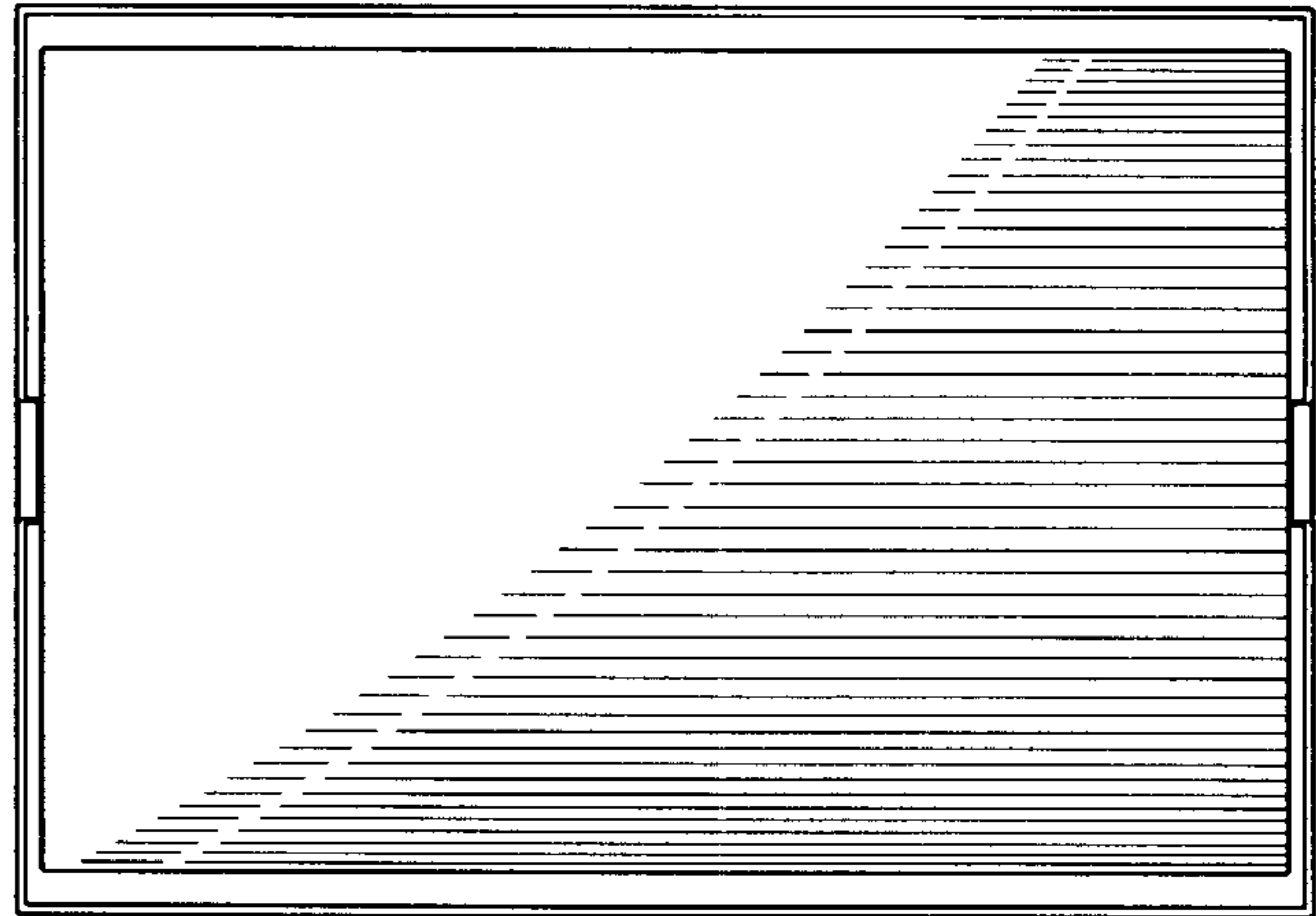

FIG. 2

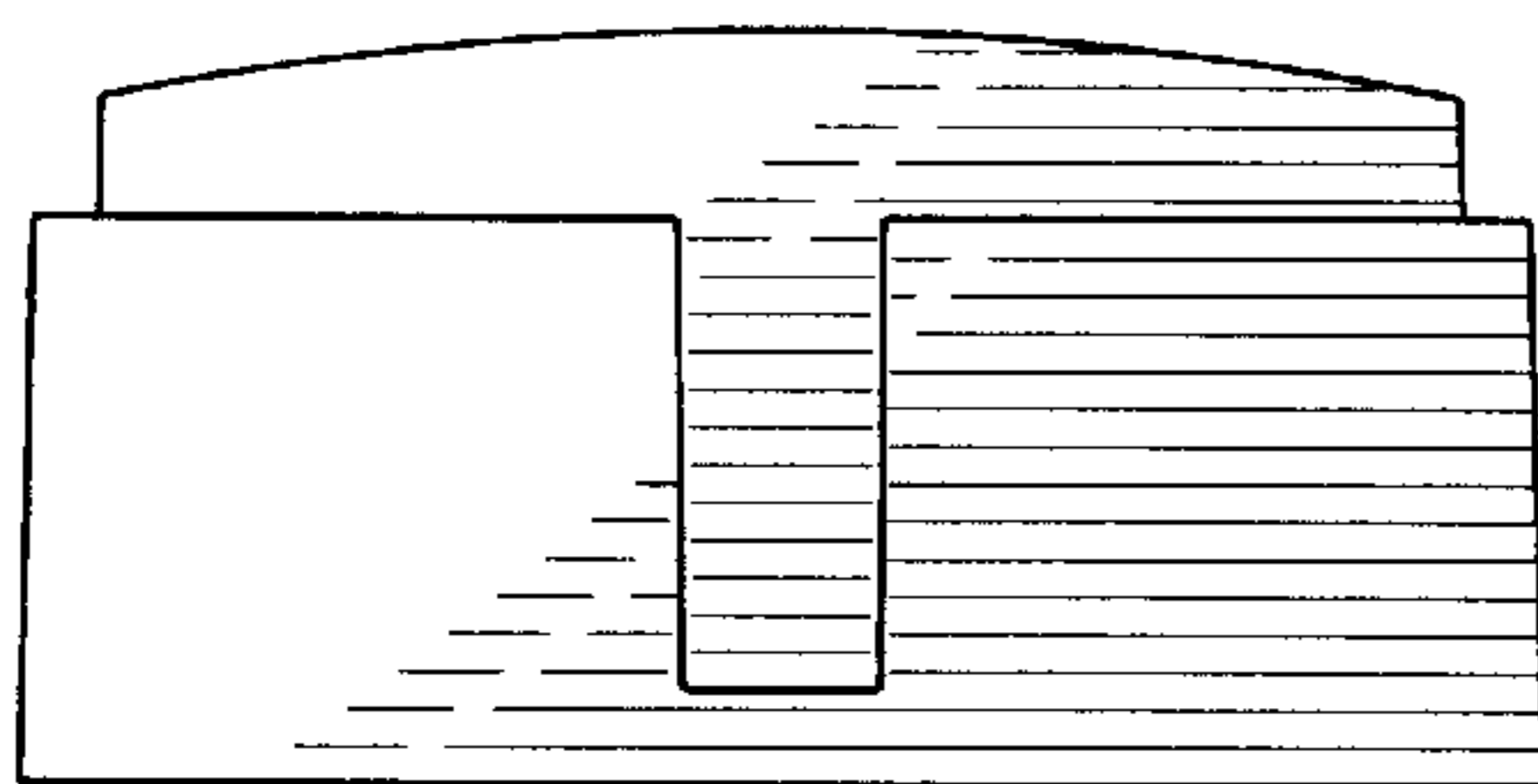

FIG. 1

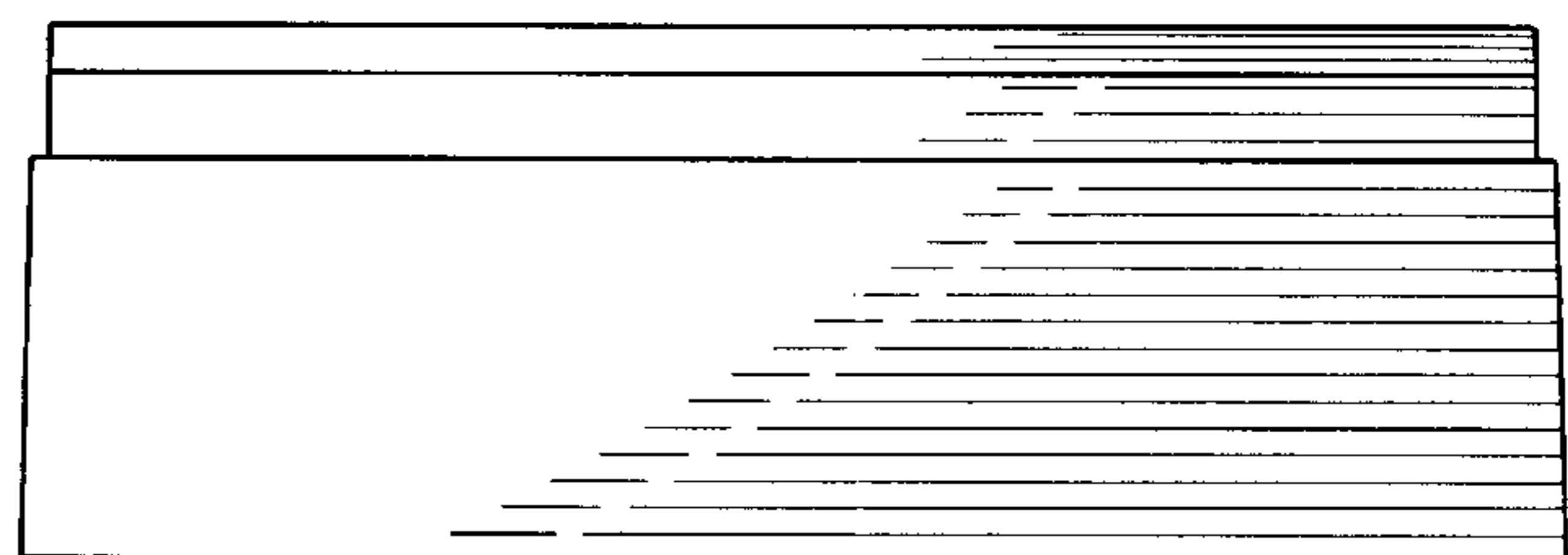

FIG. 3

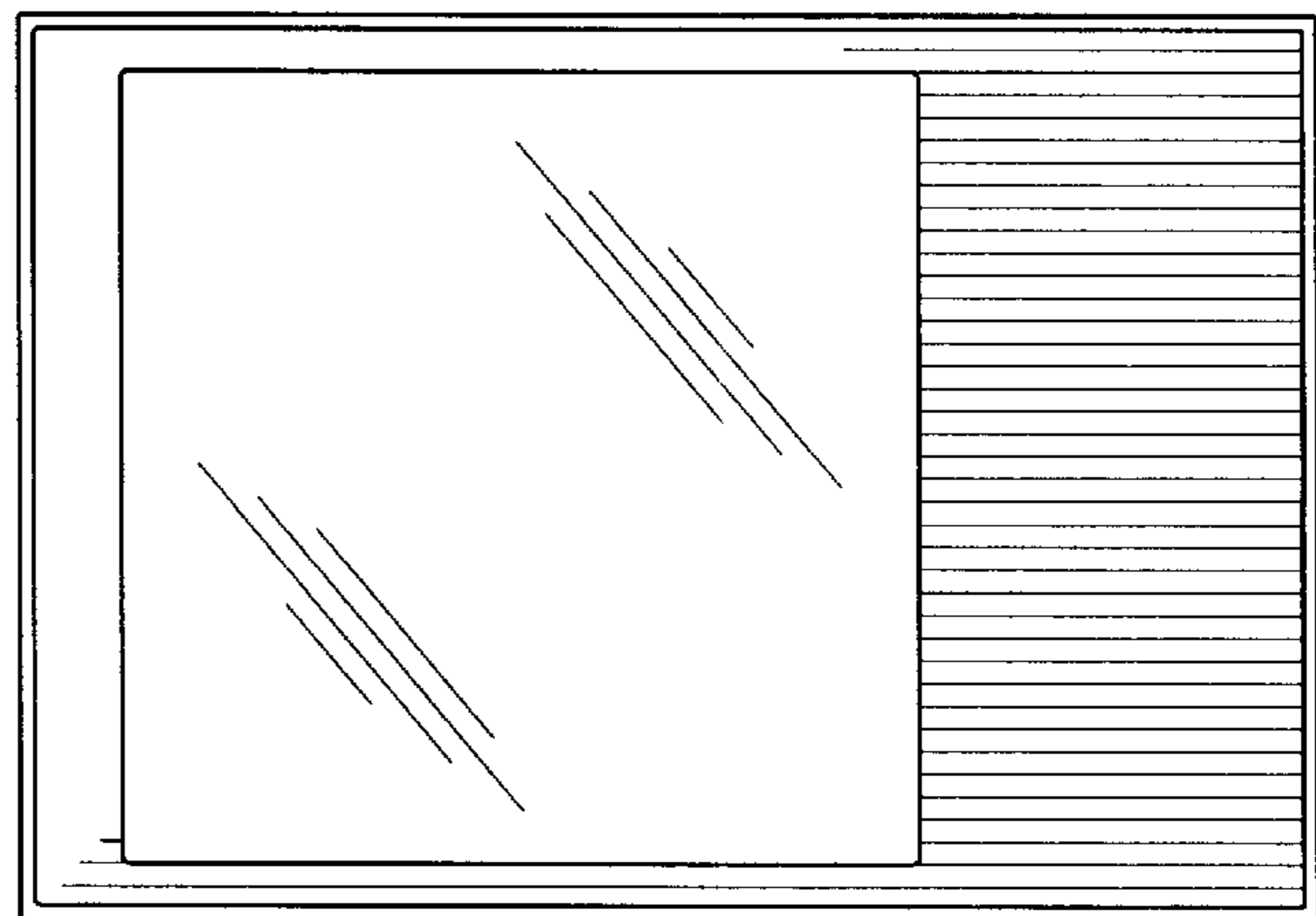

FIG. 4

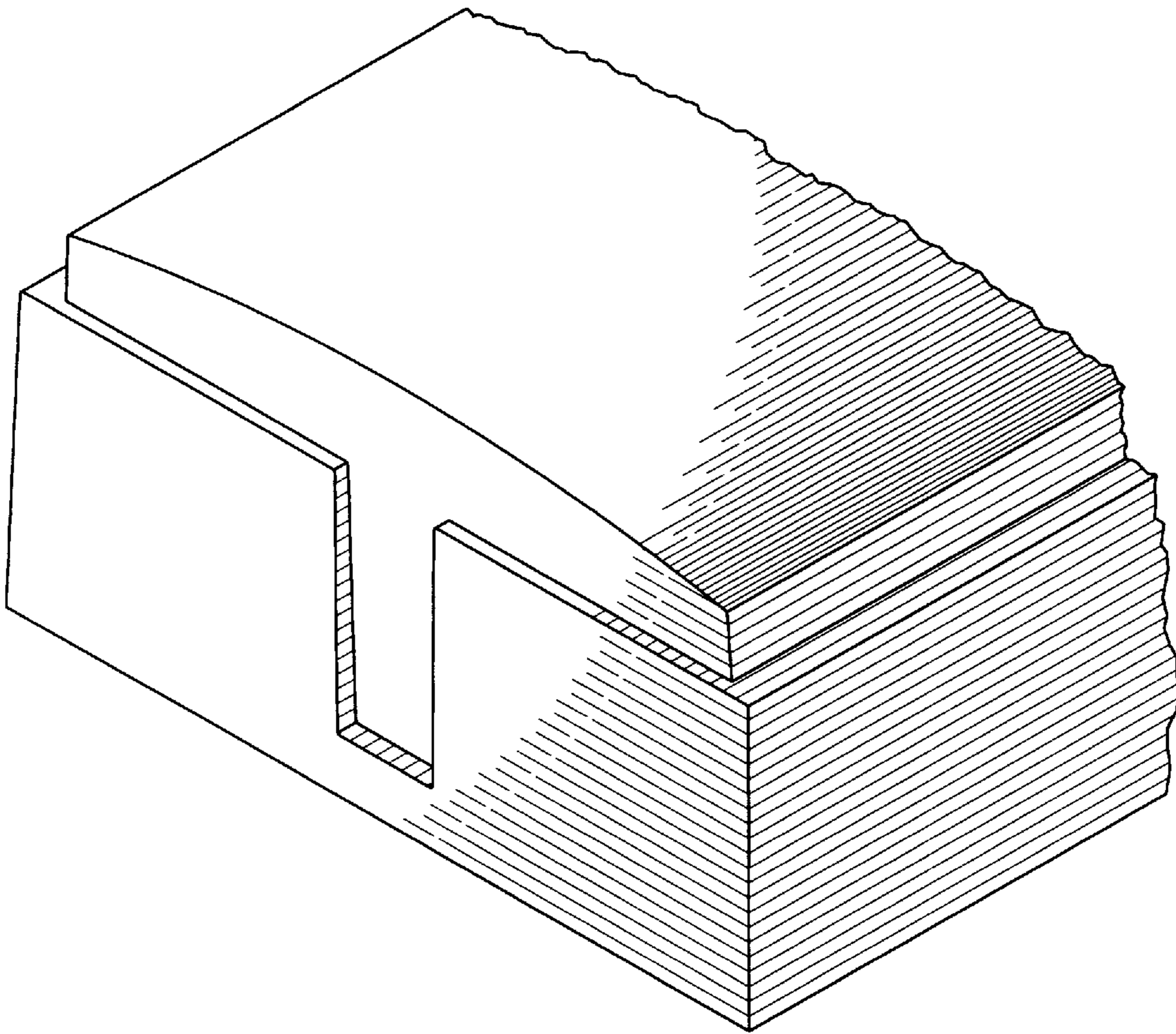

FIG. 5