



US00D399289S

# United States Patent [19]

Sheets et al.

[11] **Patent Number:** **Des. 399,289**

[45] **Date of Patent:** **\*\*Oct. 6, 1998**

[54] **FAIRWAY WOOD GOLF CLUB HEAD**

[76] Inventors: **Jeffrey D. Sheets**, 12 Southwood Dr., Wilbraham, Mass. 01095; **Tom Greene**, 6 Silver St., Monson, Mass. 01057; **Lee Trevino**, 4330 Park La., Dallas, Tex. 75220

[\*\*] Term: **14 Years**

[21] Appl. No.: **71,908**

[22] Filed: **May 30, 1997**

[51] **LOC (6) Cl.** ..... **21-02**

[52] **U.S. Cl.** ..... **D21/733**

[58] **Field of Search** ..... D21/214; 473/324, 473/327, 328, 343, 344, 345

[56] **References Cited**

**U.S. PATENT DOCUMENTS**

- D. 247,922 5/1978 Sheldon ..... D21/214
- D. 343,665 1/1994 Feche et al. .... D21/214

- D. 361,356 8/1995 Feche et al. .... D21/214
- D. 363,750 10/1995 Reed ..... D21/214
- D. 374,899 10/1996 Mahaffey ..... D21/214
- 5,271,622 12/1993 Rogerson ..... 473/327

*Primary Examiner*—Ted Shooman  
*Assistant Examiner*—Mitchell I. Siegel

[57] **CLAIM**

The ornamental design of the fairway wood golf club head, as shown and described.

**DESCRIPTION**

FIG. 1 is a perspective view of the fairway wood golf club head showing the design of our invention; FIG. 2 is an enlarged front view thereof; FIG. 3 is a top plan view of FIG. 2; FIG. 4 is a rear view of FIG. 2; FIG. 5 is a bottom view thereof of FIG. 2; FIG. 6 is a left end view of FIG. 2; and, FIG. 7 is a right end view of FIG. 2.

**1 Claim, 2 Drawing Sheets**

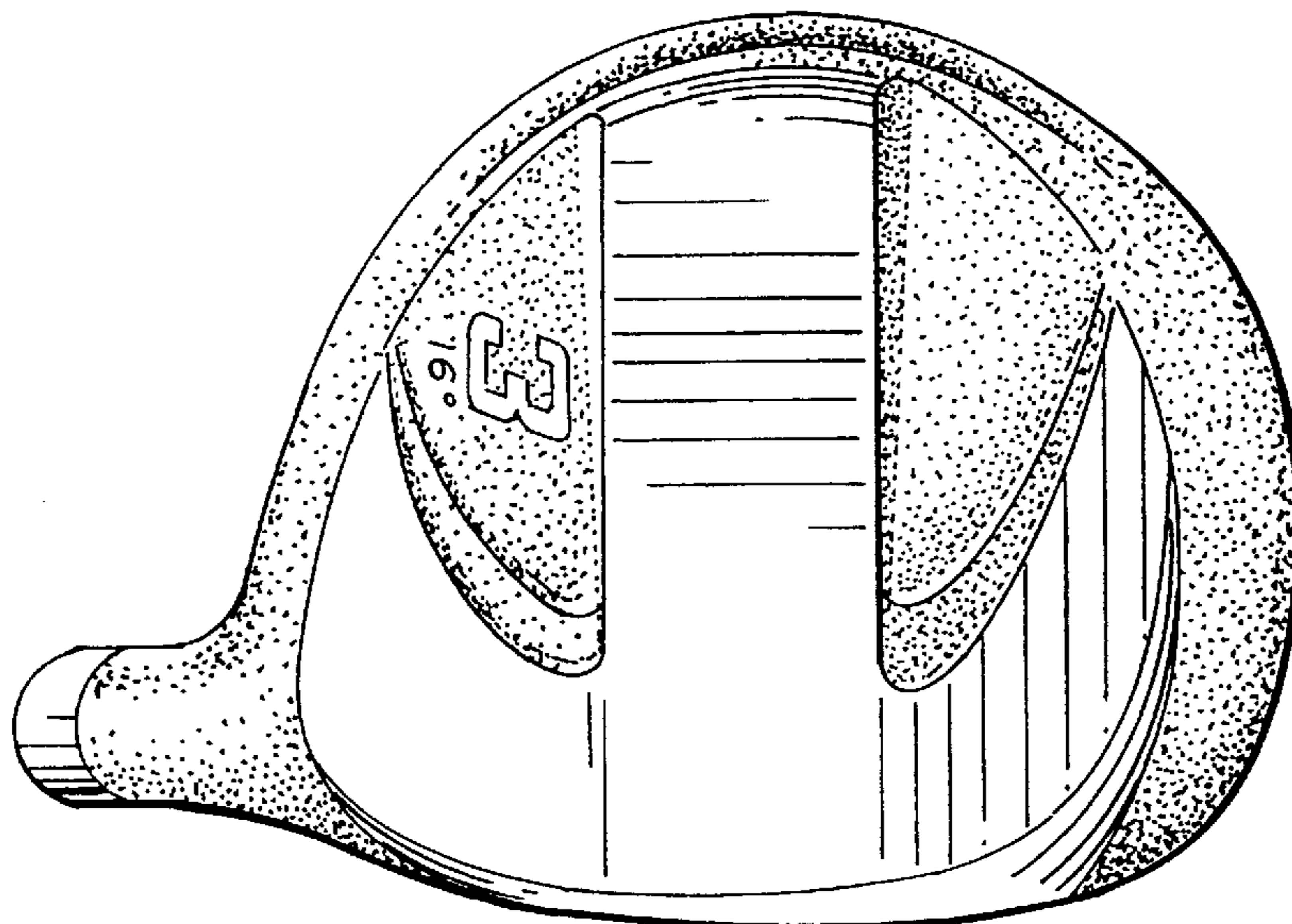
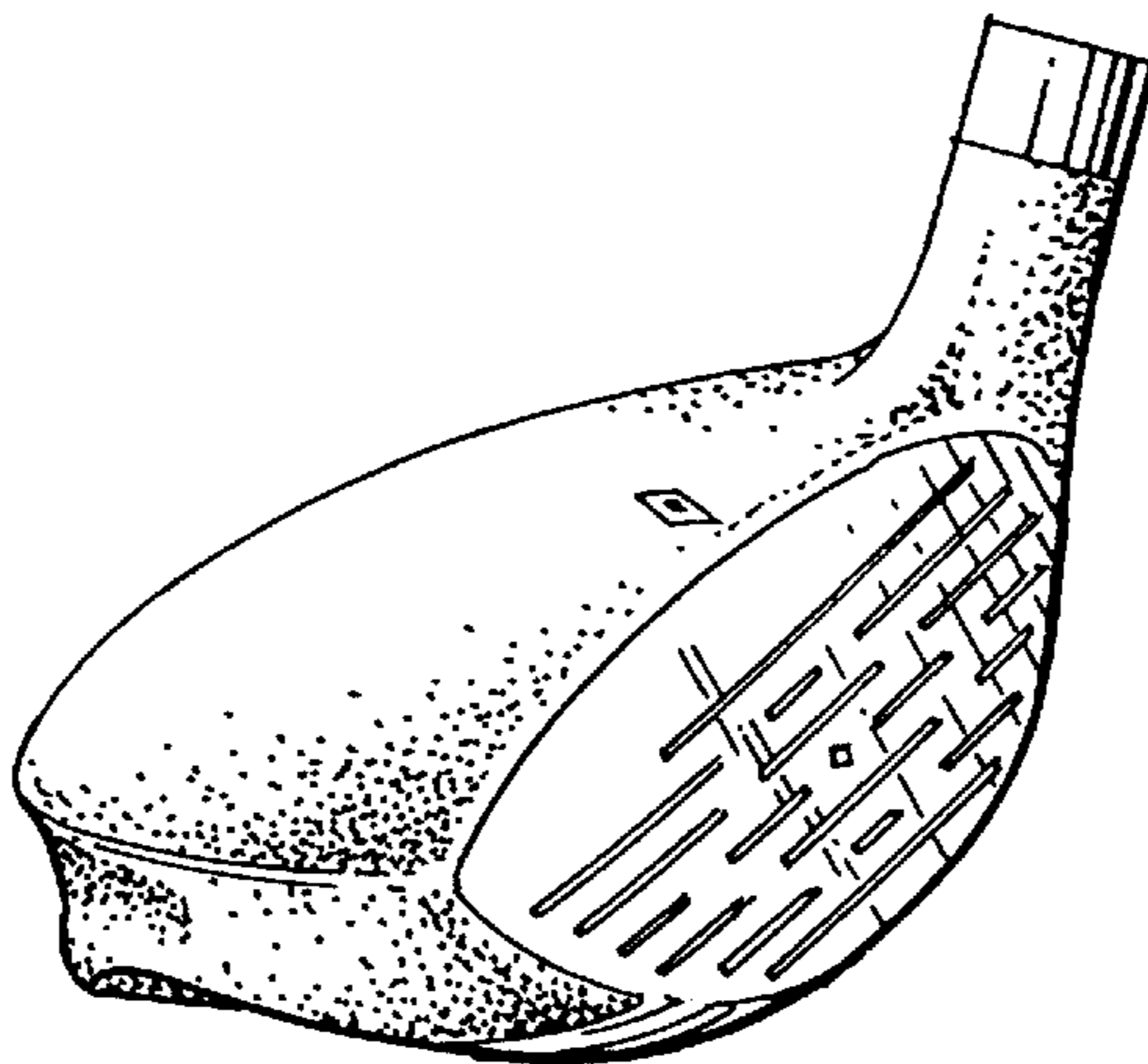

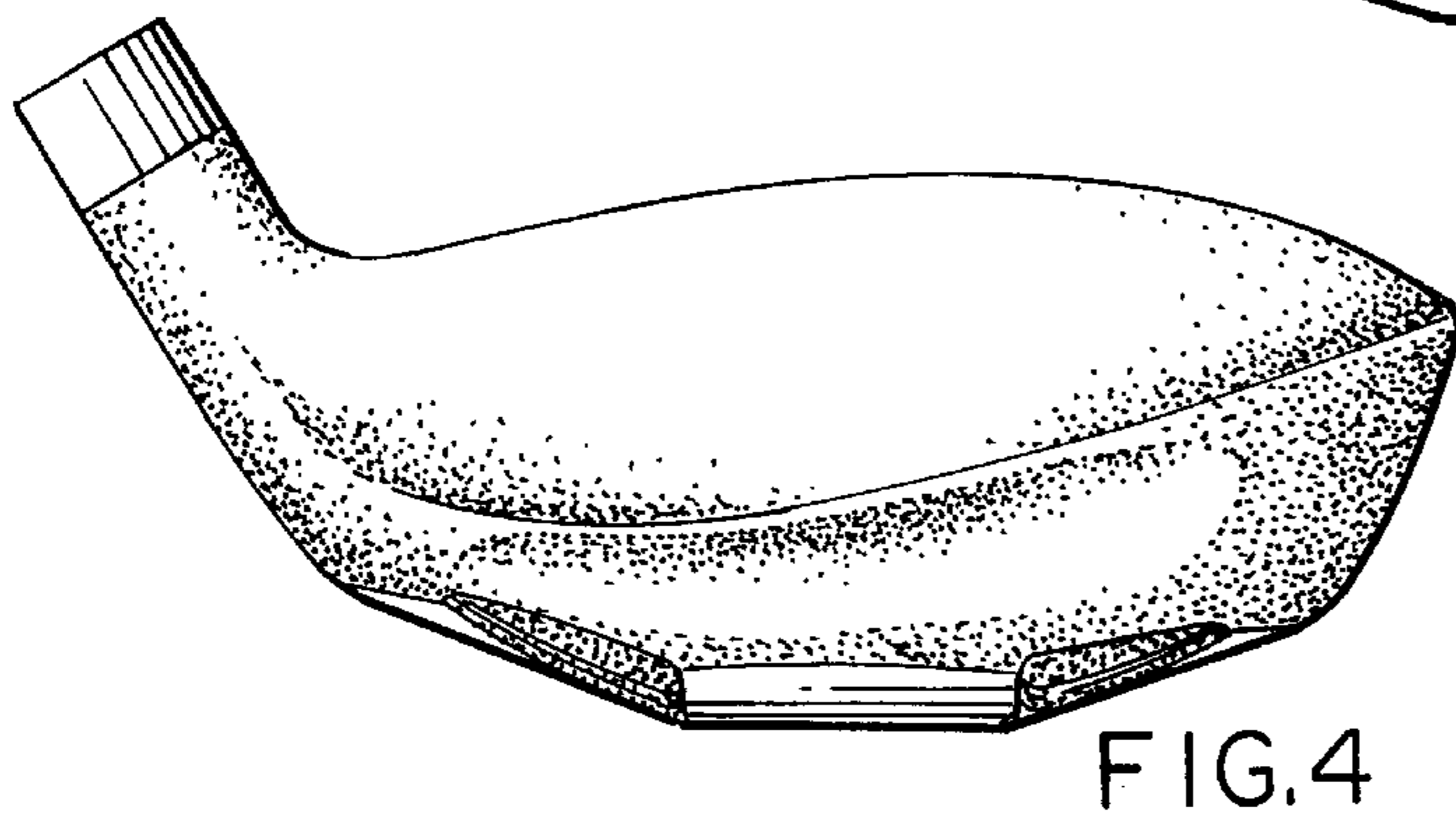
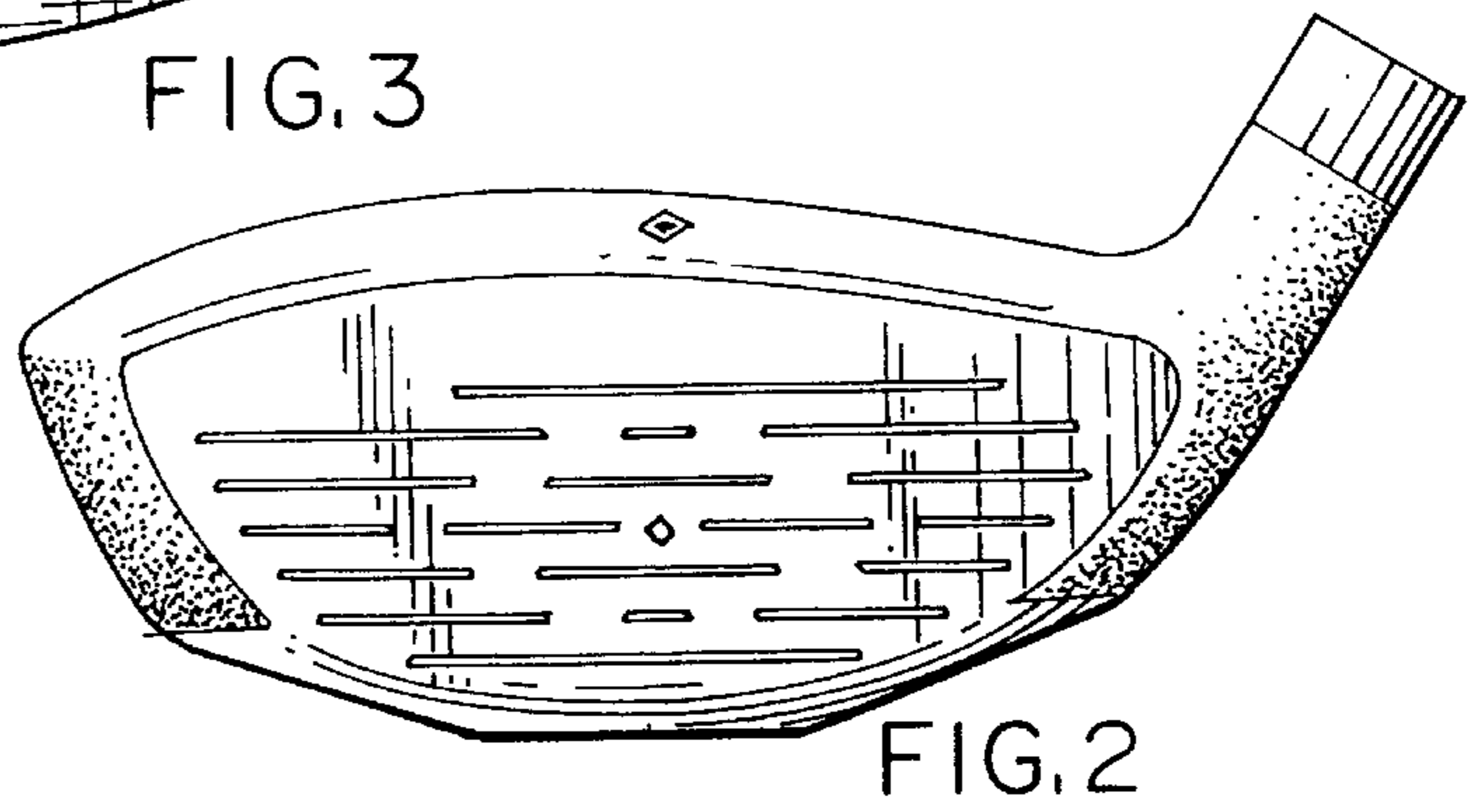
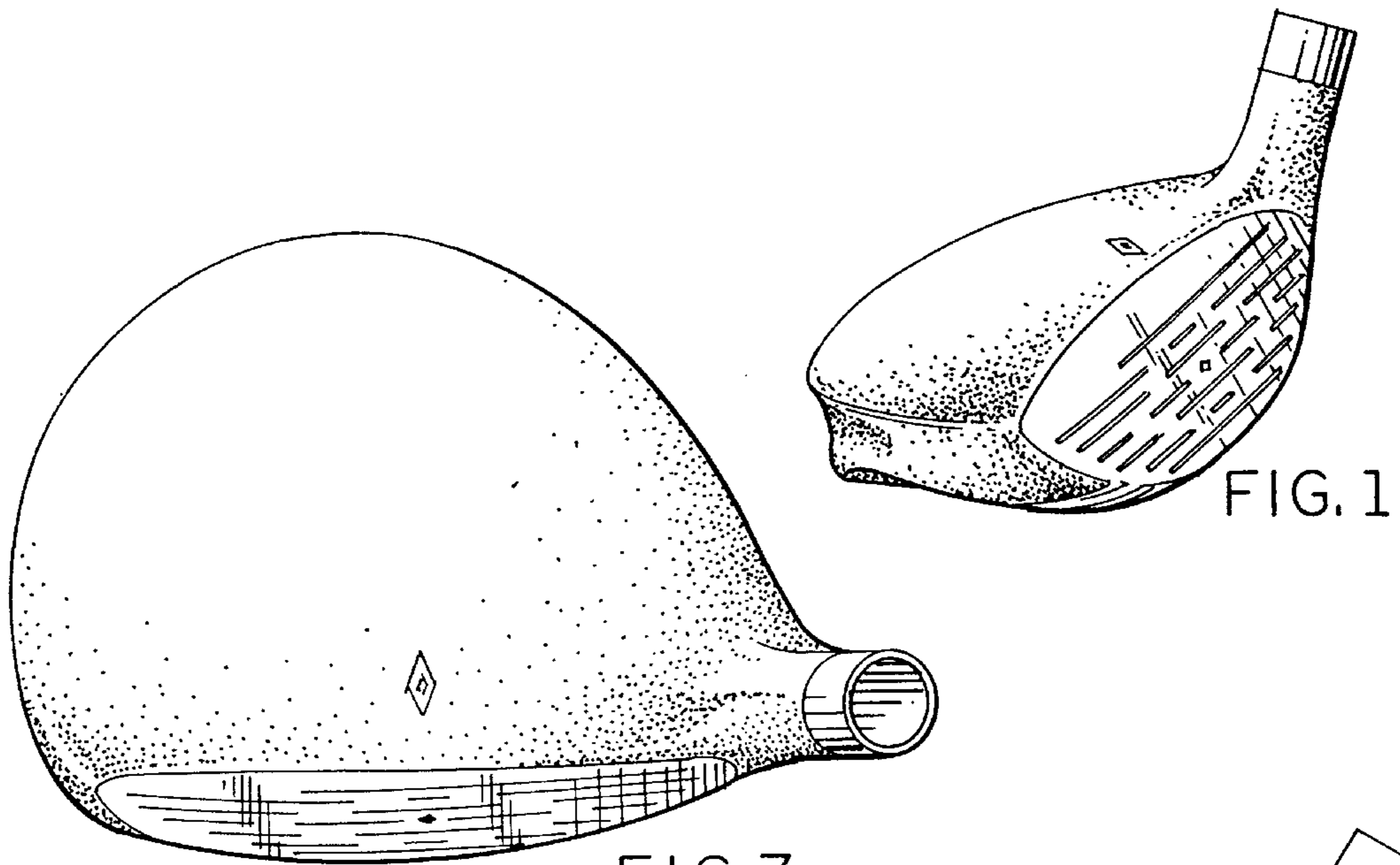

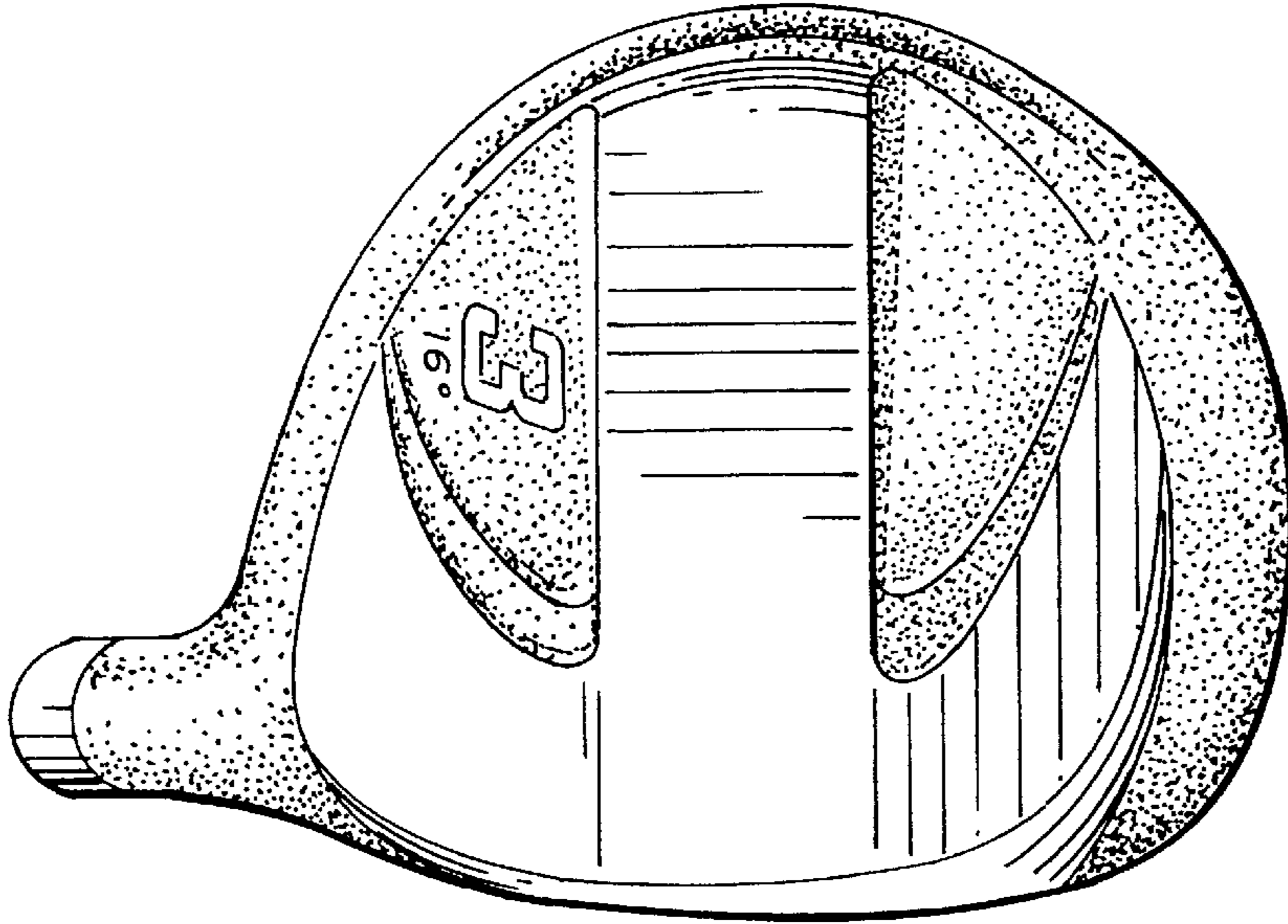

FIG. 5

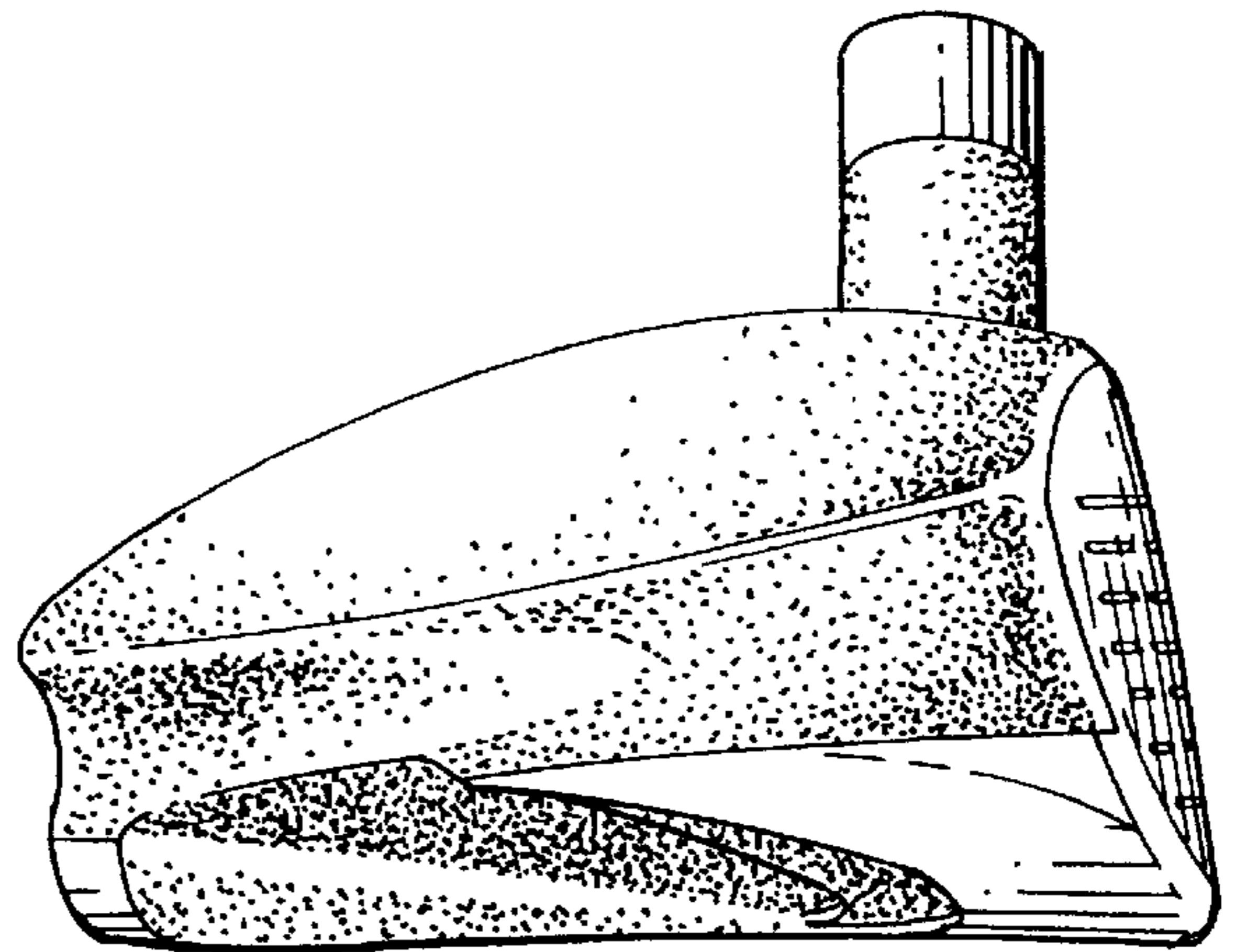

FIG. 6

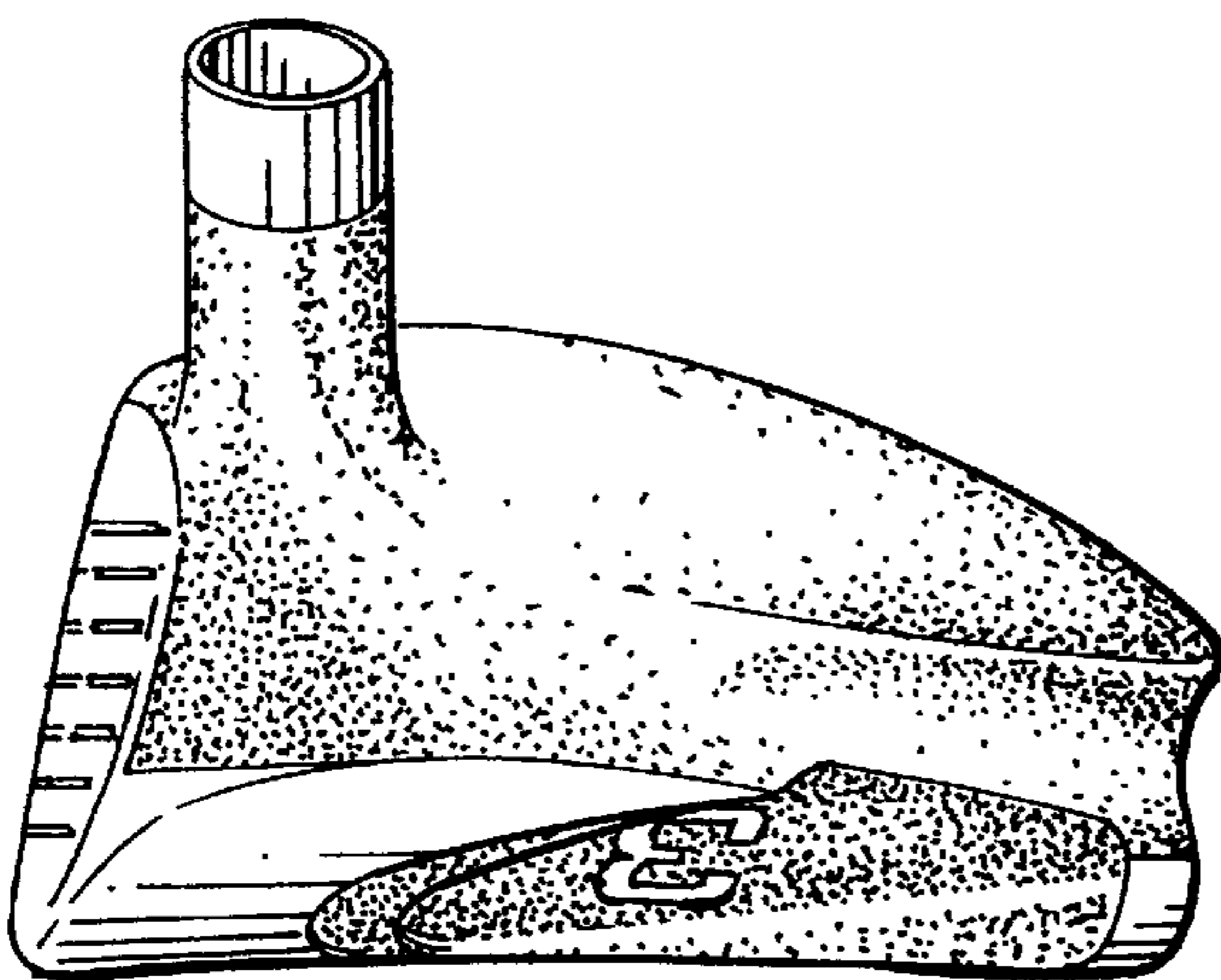

FIG. 7