



US00D399287S

United States Patent [19]
Jacobsmeier

[11] **Patent Number: Des. 399,287**

[45] **Date of Patent: **Oct. 6, 1998**

[54] **FLOATATION COLLAR**

3,992,735 11/1976 McCarthy 441/133
5,330,378 7/1994 Park 441/133

[76] Inventor: **Donald W. Jacobsmeier**, 1117
Timberlane Dr., St. Louis, Mo. 63122

Primary Examiner—Kay H. Chin

[**] Term: **14 Years**

[57] **CLAIM**

[21] Appl. No.: **69,028**

The ornamental design for a floatation collar, as shown and described.

[22] Filed: **Apr. 28, 1997**

DESCRIPTION

[51] **LOC (6) Cl.** **12-06**

FIG. 1 is a top plan view of a floatation collar showing my new design;

[52] **U.S. Cl.** **D21/237**

FIG. 2 is a bottom plan view thereof;

[58] **Field of Search** D21/228, 236,
D21/237, 238; 441/75, 74, 111, 113, 133,
129-131; 482/55, 131, 129

FIG. 3 is a front elevational view thereof;

FIG. 4 is a rear elevational view thereof;

FIG. 5 is a perspective view illustrating attachment of the collar to an end of wrapped on a fishing pole;

FIG. 6 is a side view thereof on a fishing net handle; and,
FIG. 7 is another side view thereof on a gaffe handle.

[56] **References Cited**

U.S. PATENT DOCUMENTS

D. 296,919	7/1988	Faulconer et al.	D21/238
D. 303,278	9/1989	Nealy	D21/228
D. 330,930	11/1992	McCroory	D21/236
D. 342,560	12/1993	Cross	D21/237
3,908,548	9/1975	Wedding	441/133

The broken lines shown in FIGS. 5, 6, and 7 are for illustrative purposes only and form no part of the claim design.

1 Claim, 2 Drawing Sheets

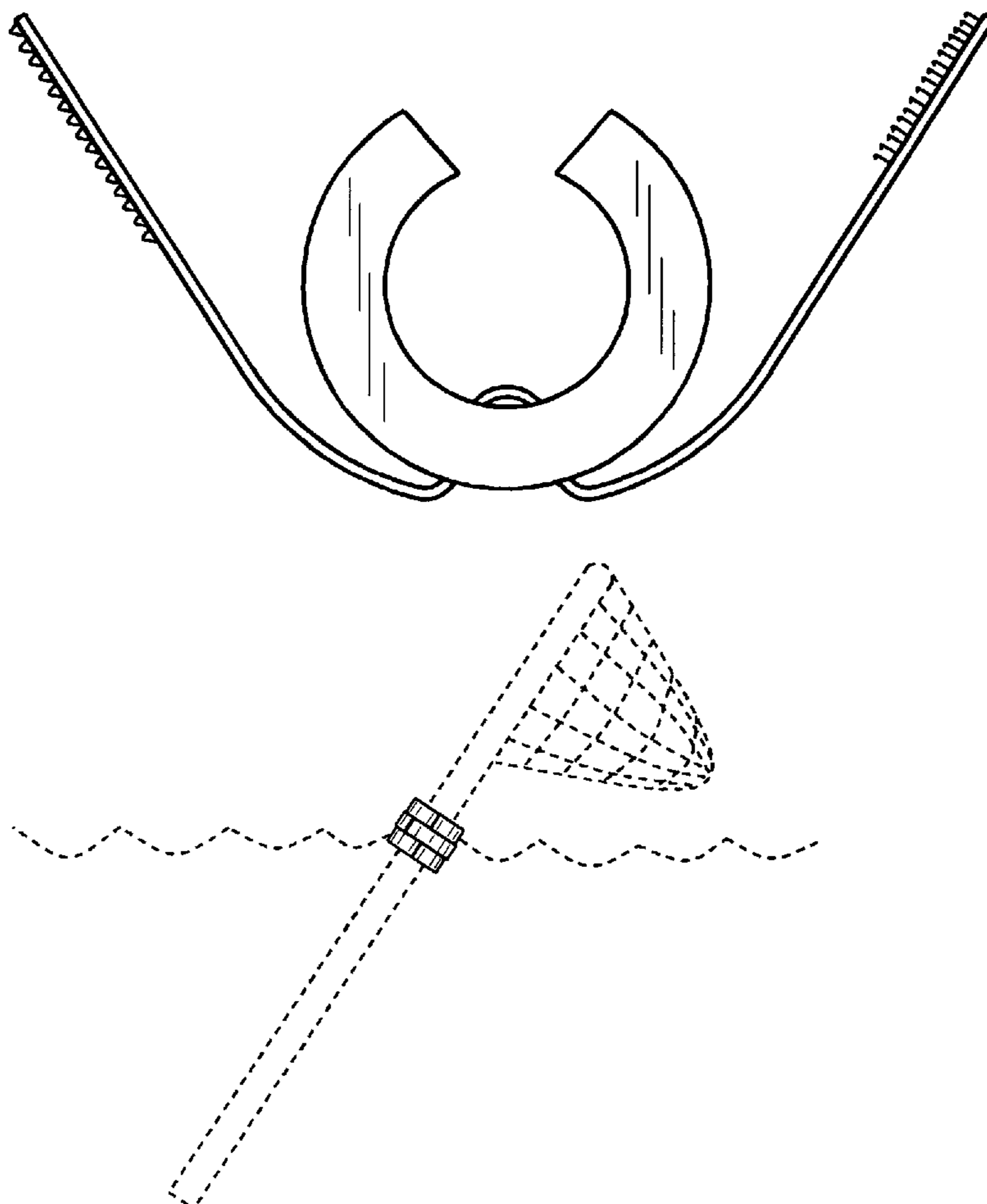

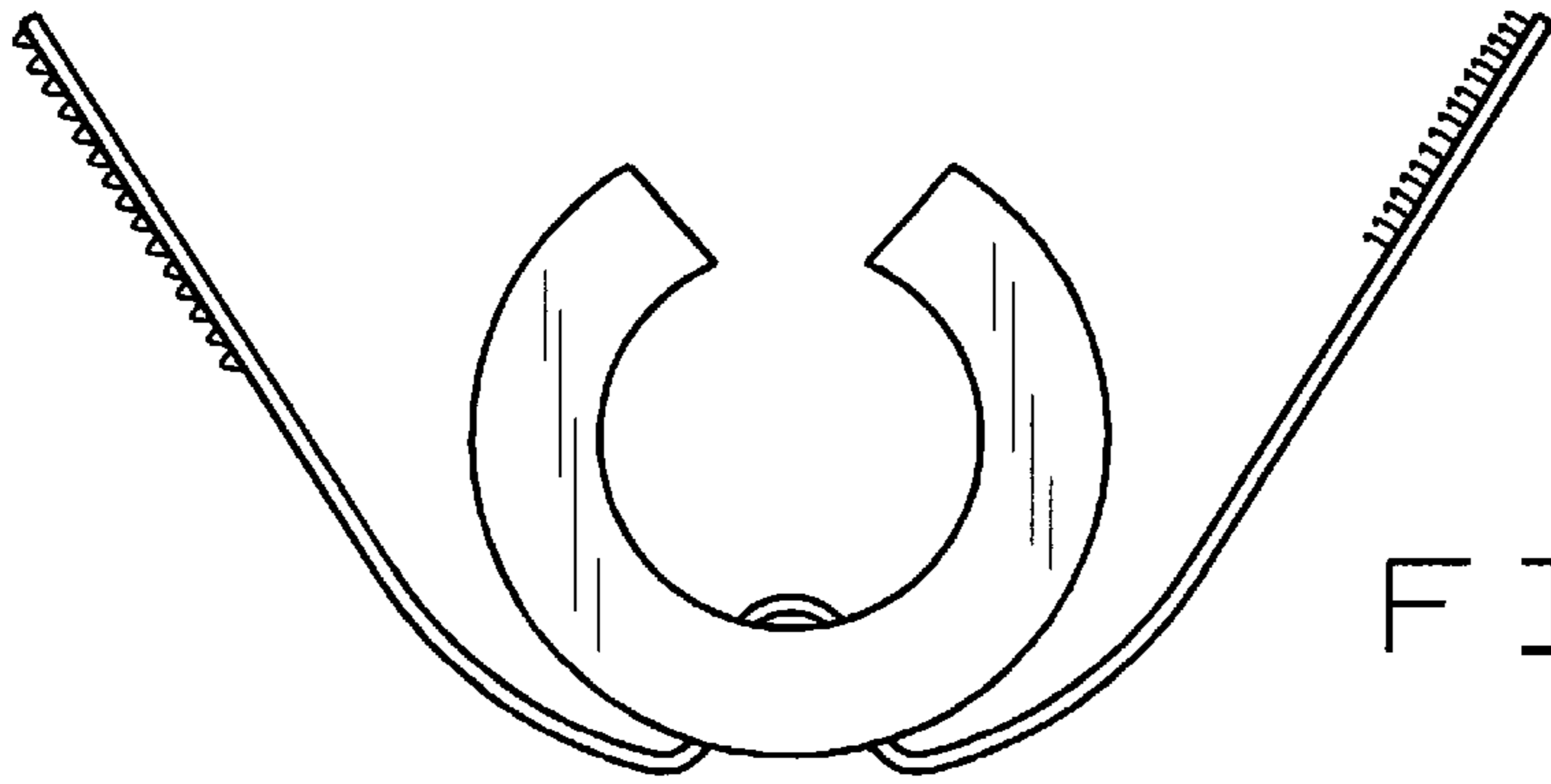

FIG. 1

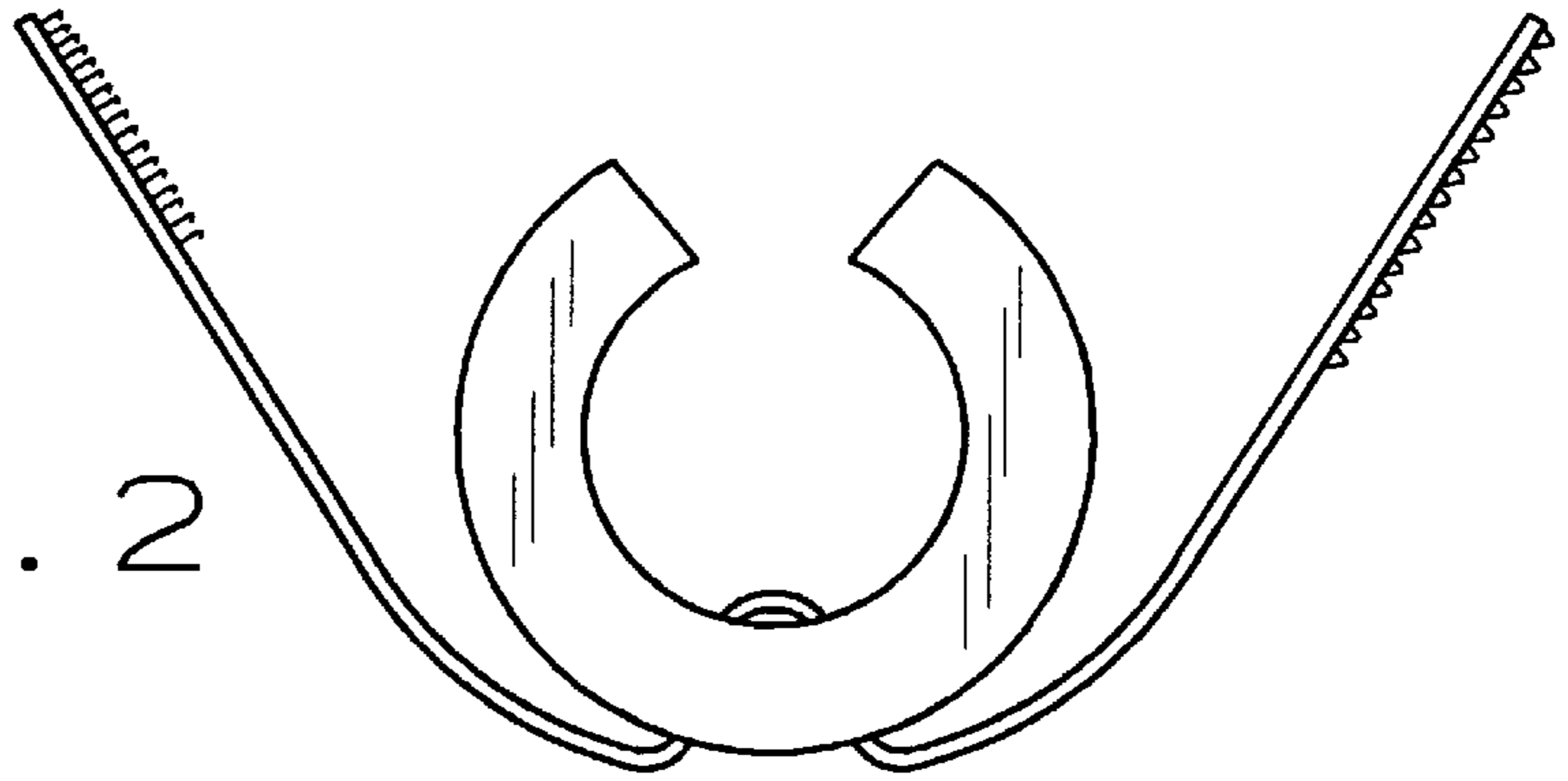

FIG. 2

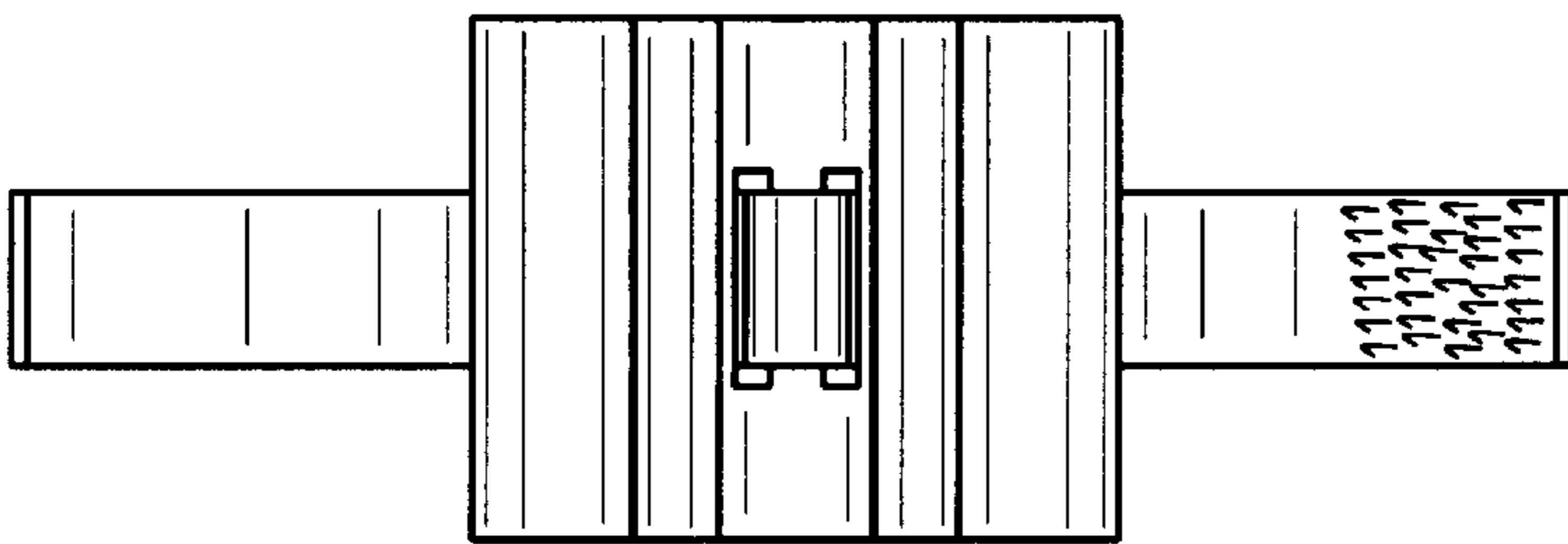

FIG. 3

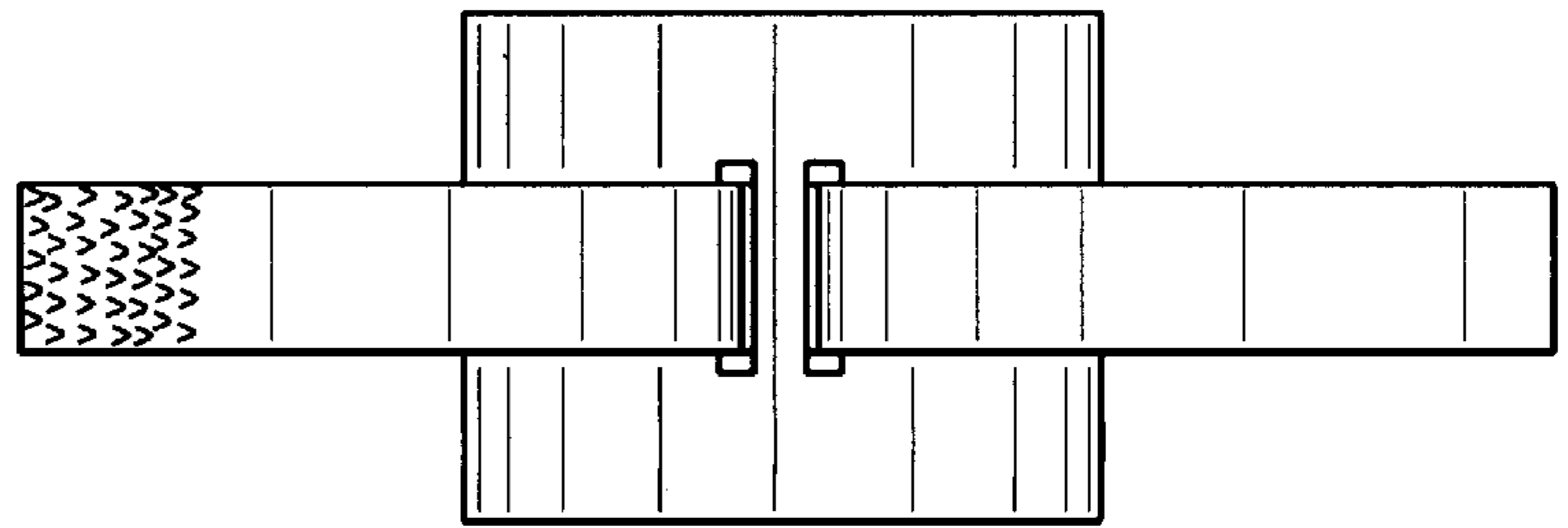

FIG. 4

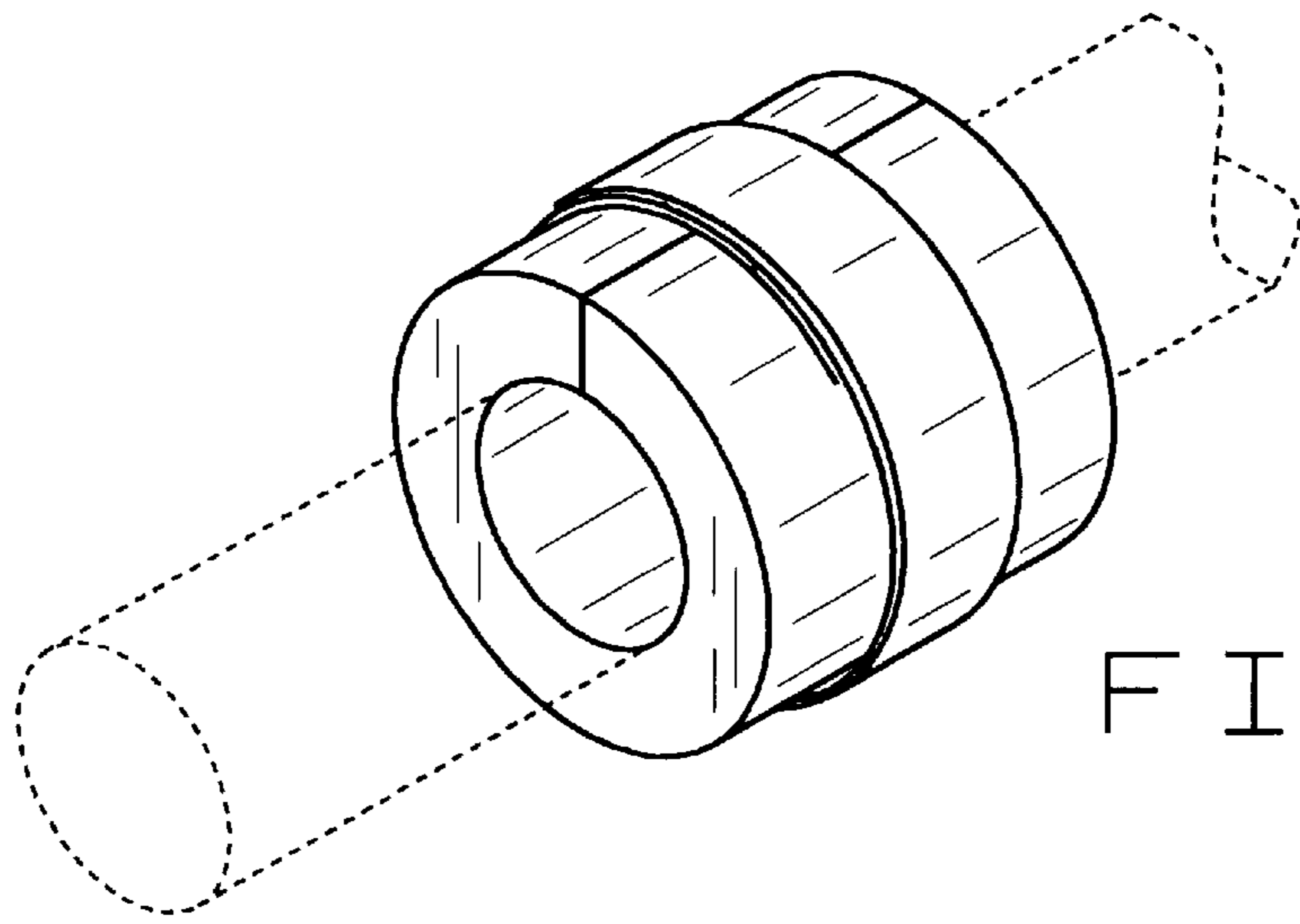

FIG. 5

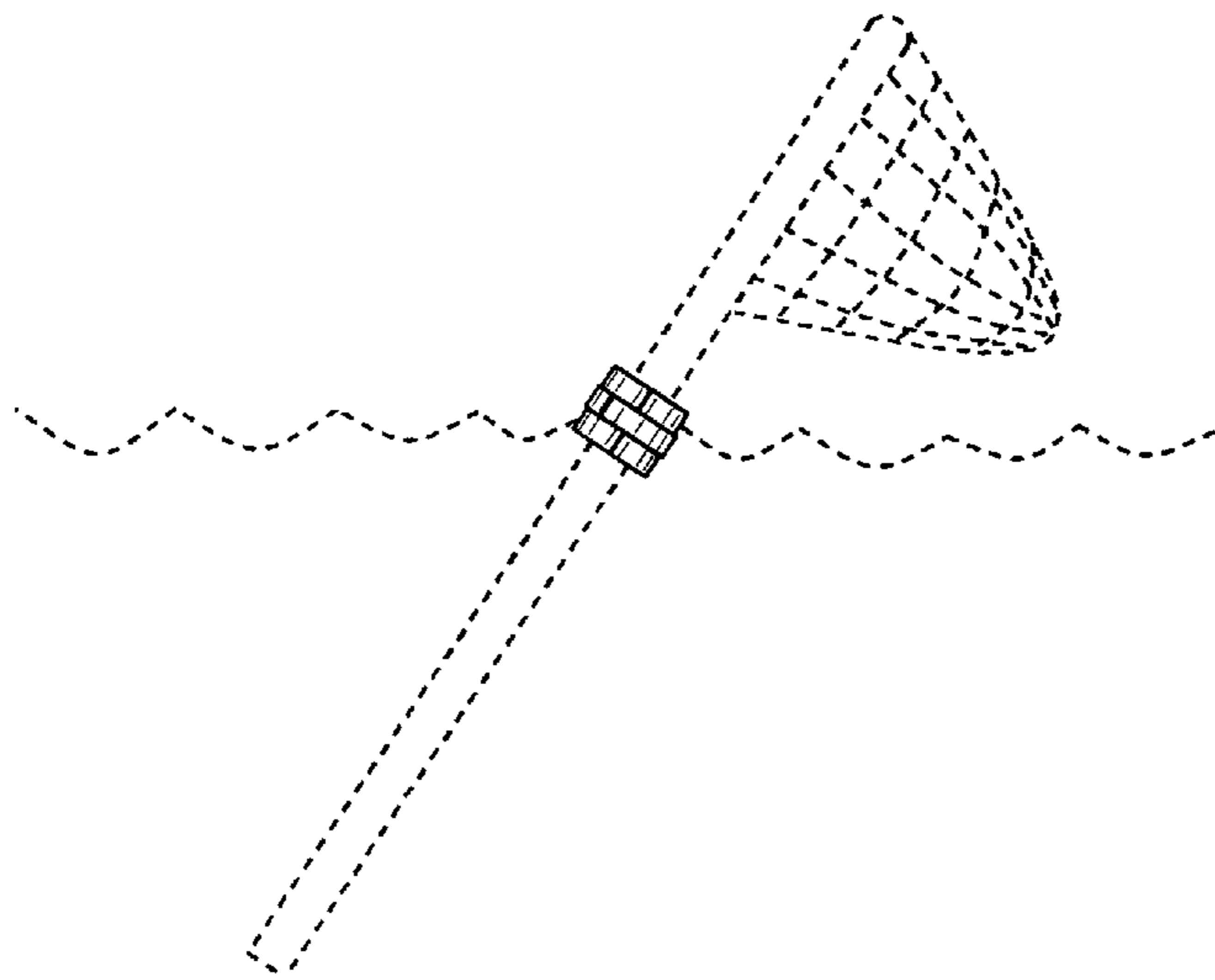

FIG. 6

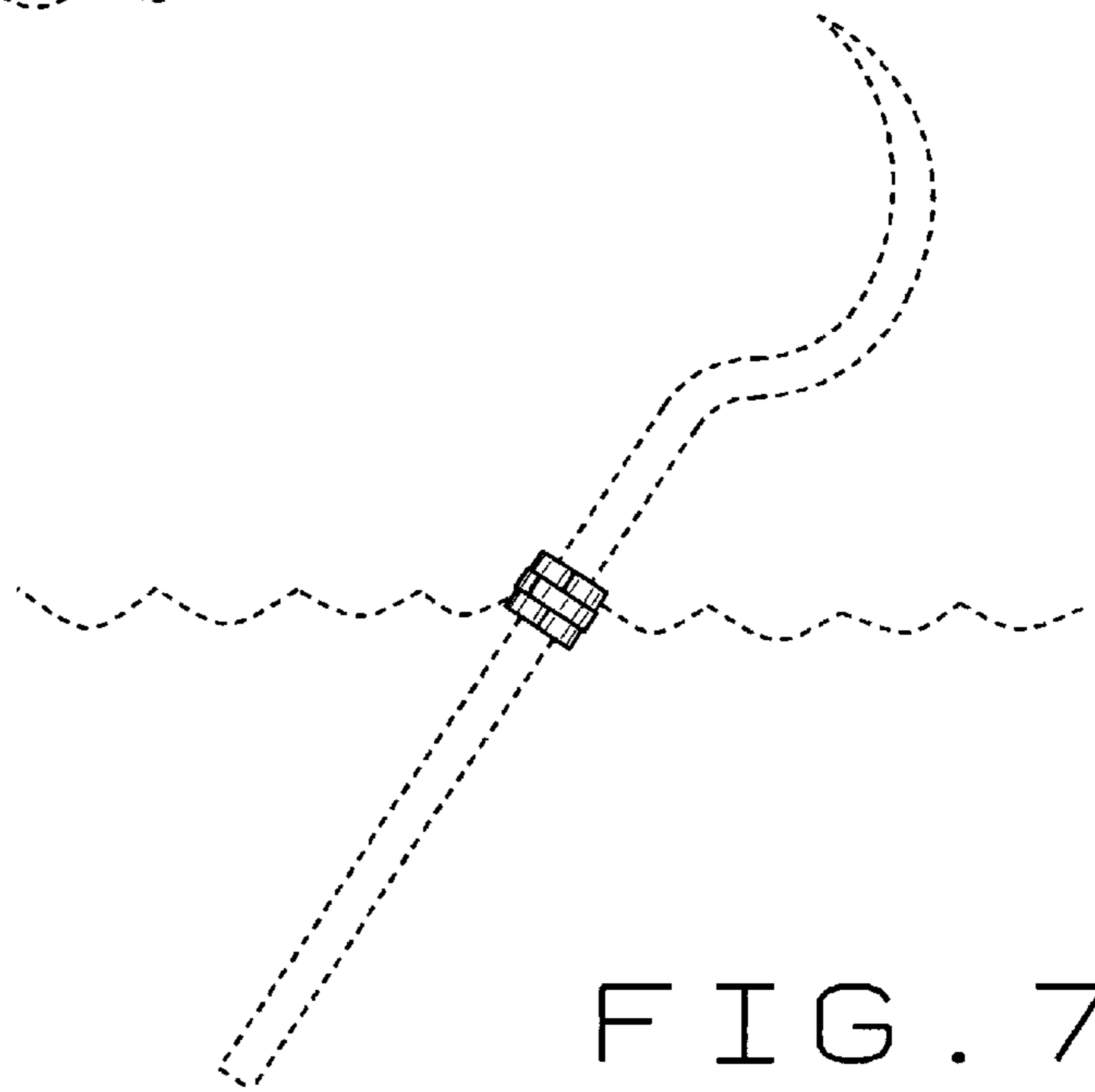

FIG. 7