



US00D399266S

United States Patent [19] Yamazaki

[11] Patent Number: **Des. 399,266**

[45] Date of Patent: ****Oct. 6, 1998**

[54] **BALL GAME**

[75] Inventor: **Junko Yamazaki**, Tokyo, Japan

[73] Assignee: **Tomy Company, Ltd.**, Tokyo, Japan

[**] Term: **14 Years**

[21] Appl. No.: **76,111**

[22] Filed: **Sep. 4, 1997**

[30] Foreign Application Priority Data

Mar. 18, 1997 [JP] Japan 9-7931

[51] **LOC (6) Cl.** **21-01**

[52] **U.S. Cl.** **D21/12**

[58] **Field of Search** D21/1, 11, 12,
D21/7, 8; 273/118 R, 119 R, 120 R, 109,
117, 129 W, 368, 374, 459, 461, 317.1;
224/919

[56] References Cited

U.S. PATENT DOCUMENTS

D. 133,047 7/1942 Weiss D21/12

D. 183,649	10/1958	Gaston	D21/12
D. 364,428	11/1995	Caron	D21/12
1,769,327	7/1930	Wood	D21/12 X
3,388,483	6/1968	Weisbecker	273/118 R
5,184,735	2/1993	Black	224/919 X
5,186,374	2/1993	Buxton	224/919 X
5,358,241	10/1994	Anghelo et al.	273/118 R
5,370,391	12/1994	Hilzendegeer et al.	273/118 R
5,511,783	4/1996	Popadiuk et al.	273/18 R

Primary Examiner—Prabhakar G. Deshmukh
Attorney, Agent, or Firm—Staas & Halsey

[57] CLAIM

The ornamental design for ball game, as shown.

DESCRIPTION

FIG. 1 is a front elevational view;
FIG. 2 is a rear elevational view;
FIG. 3 is a top plan view;
FIG. 4 is a bottom plan view;
FIG. 5 is a right side elevational view; and,
FIG. 6 is a left side elevational view.

1 Claim, 3 Drawing Sheets

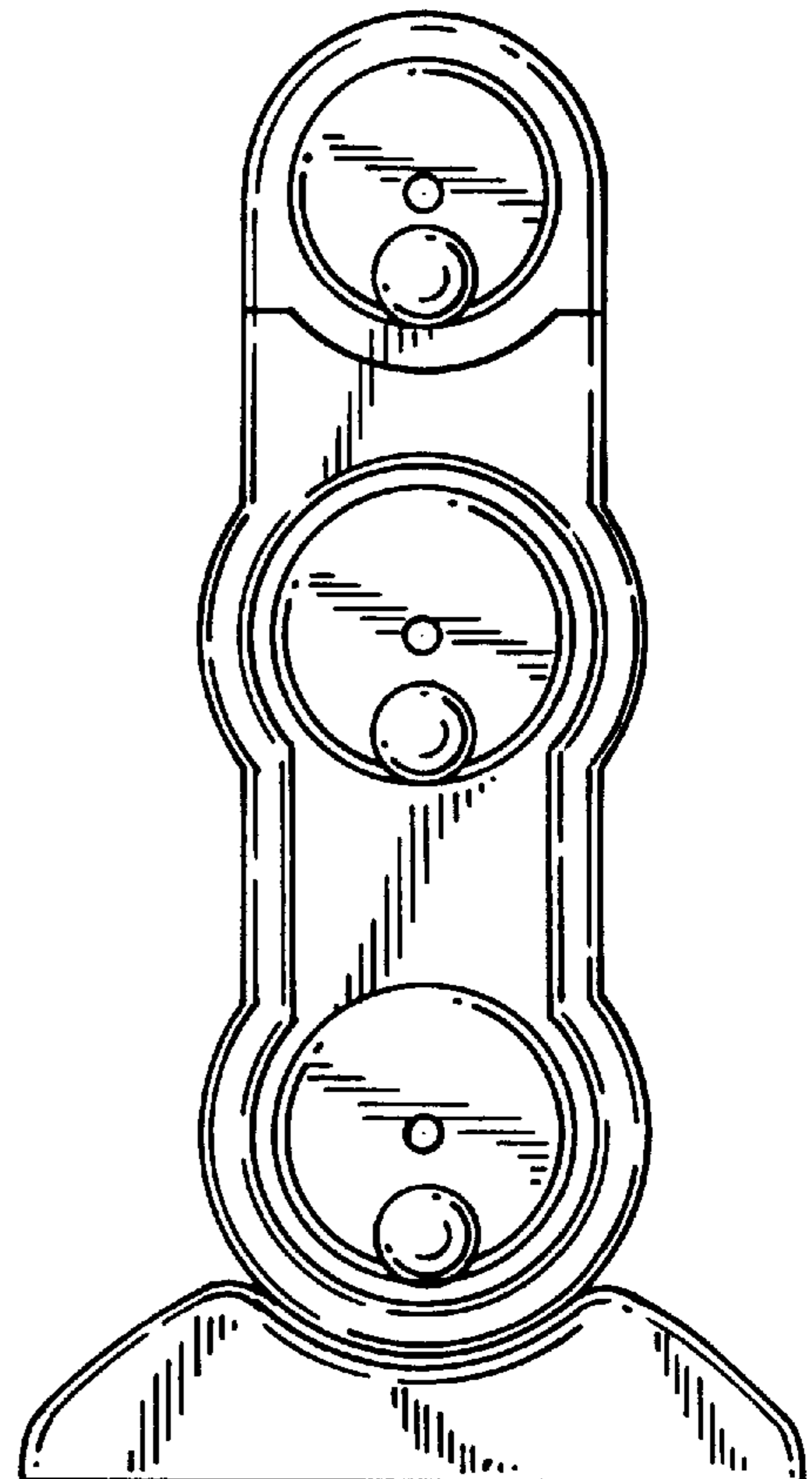
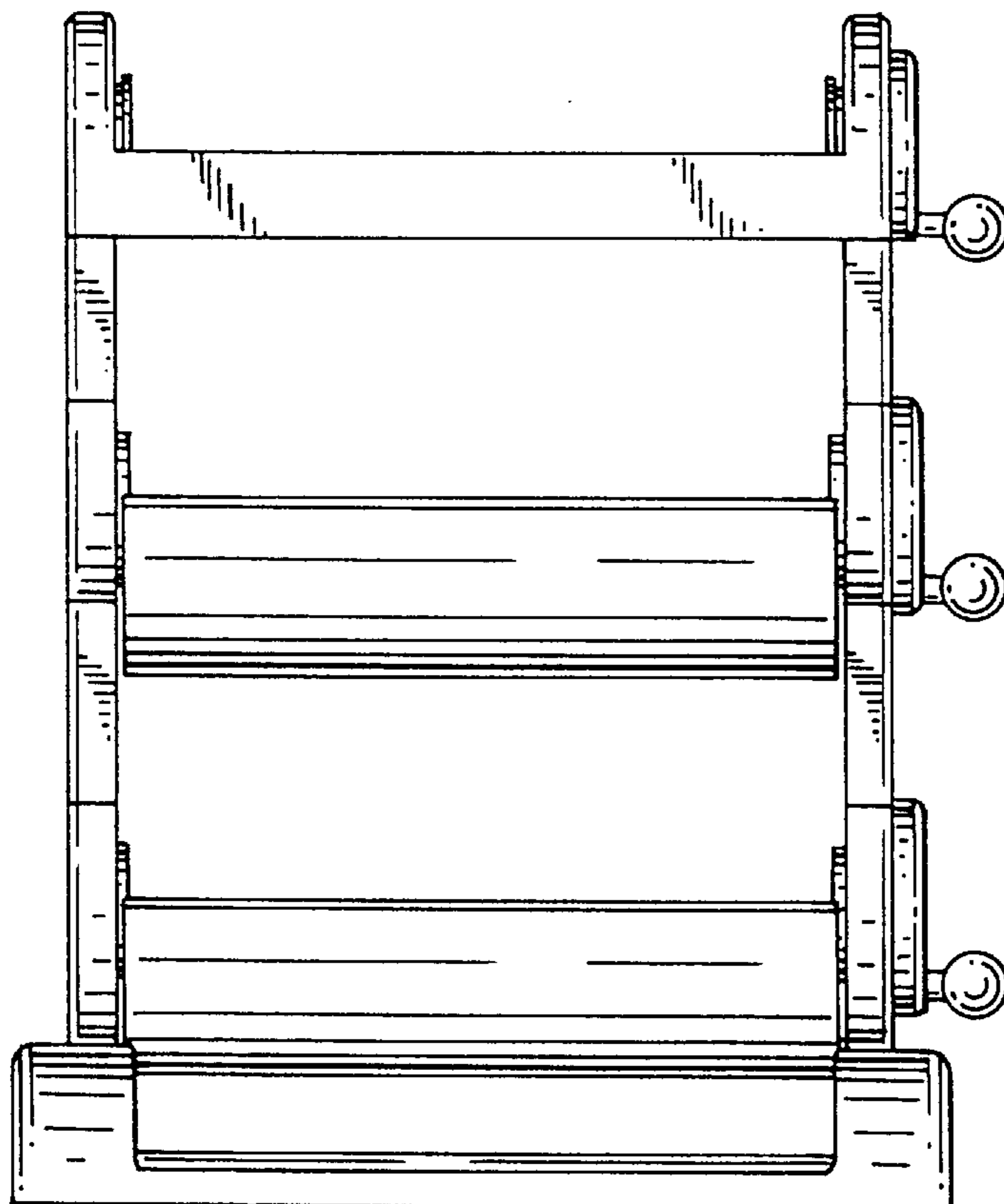

FIG. 2

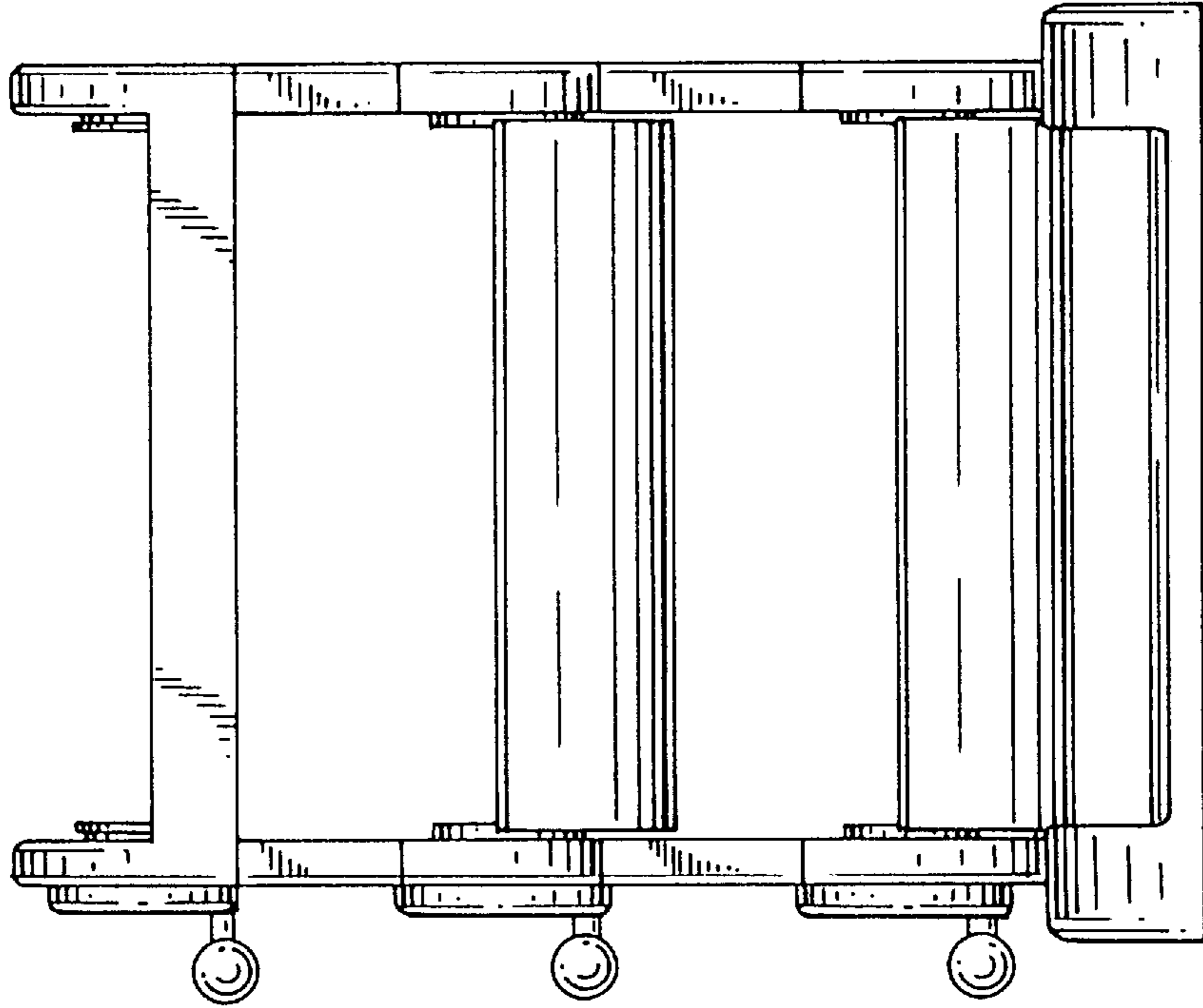

FIG. 1

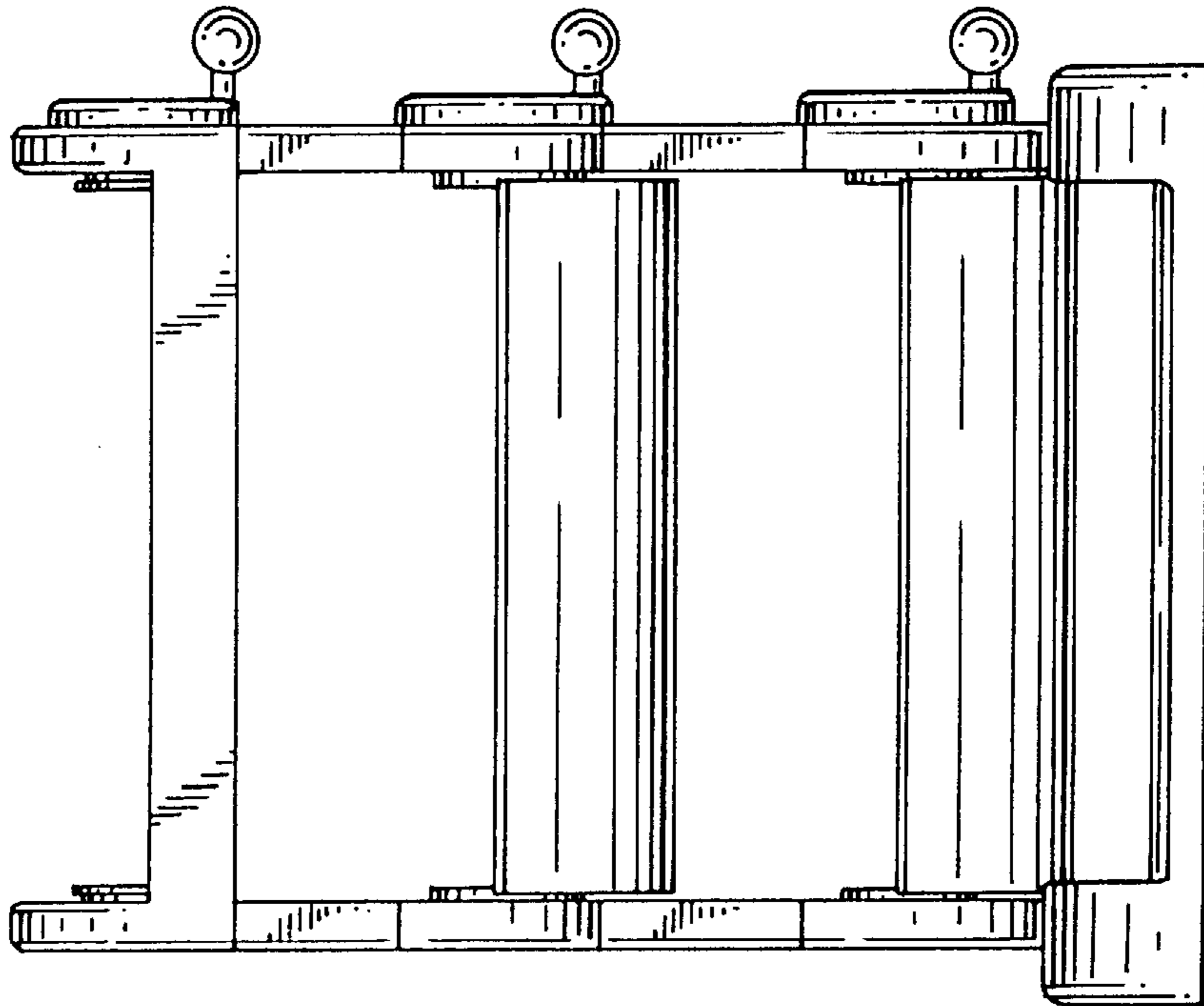

FIG. 3

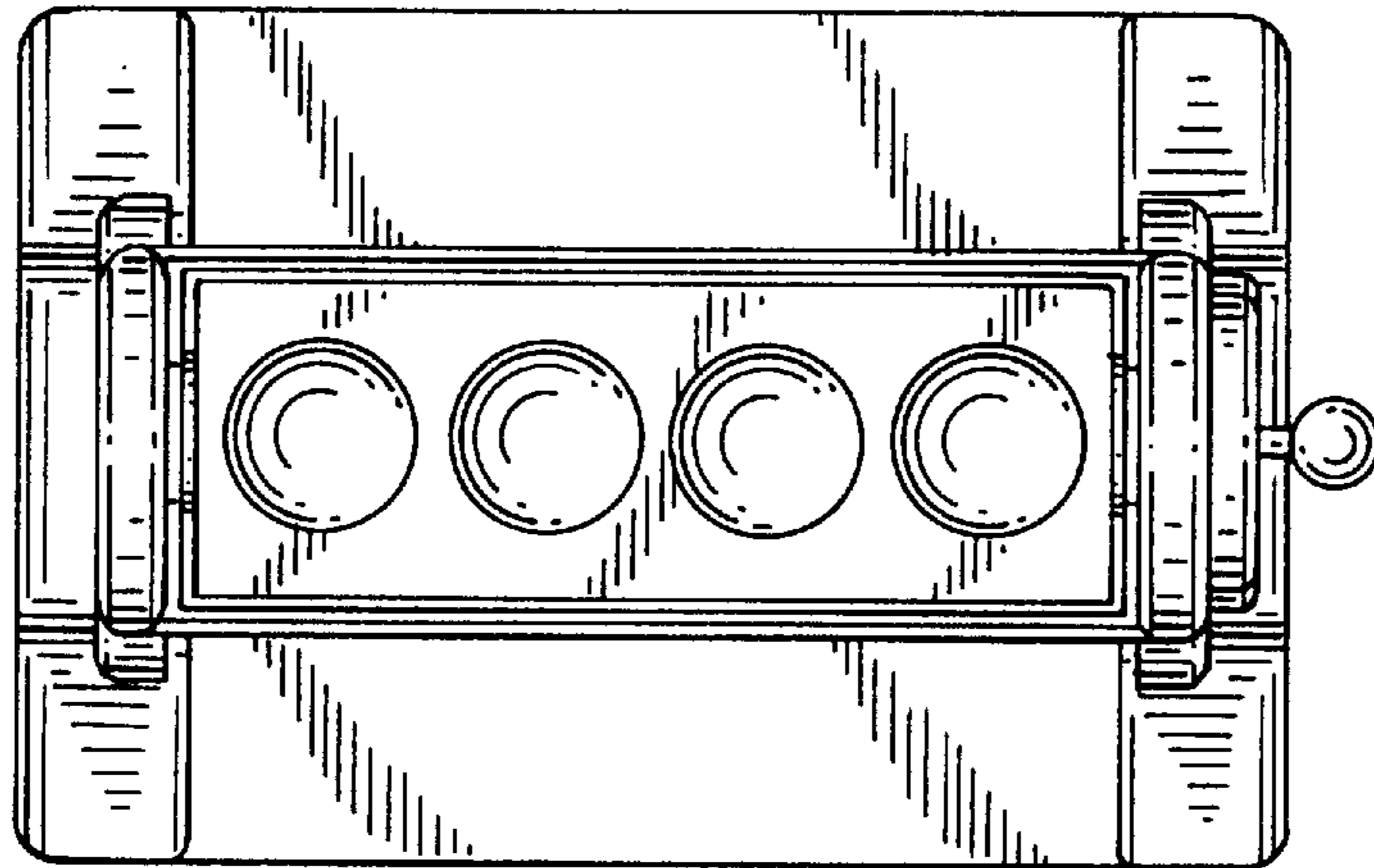

FIG. 4

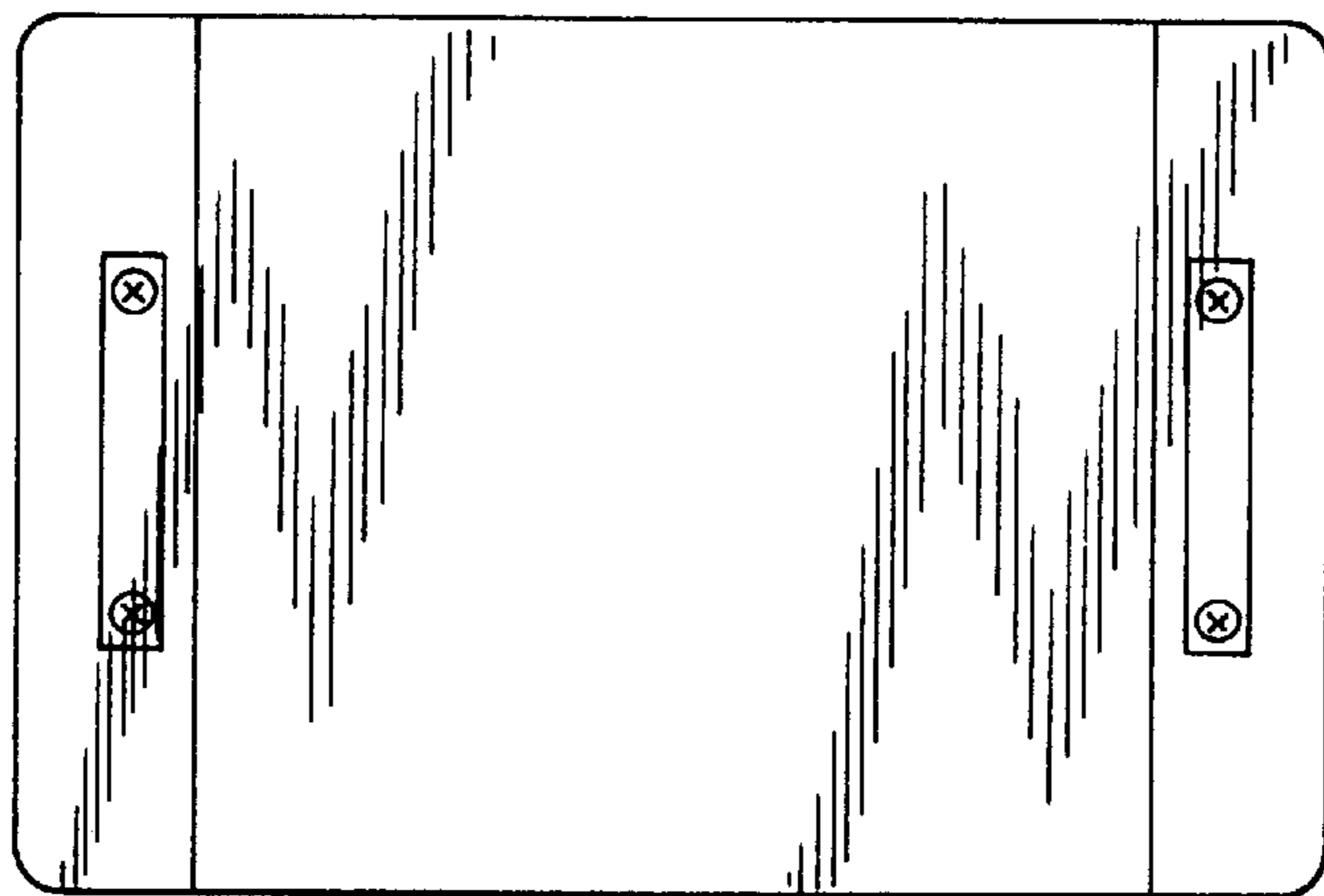

FIG. 5

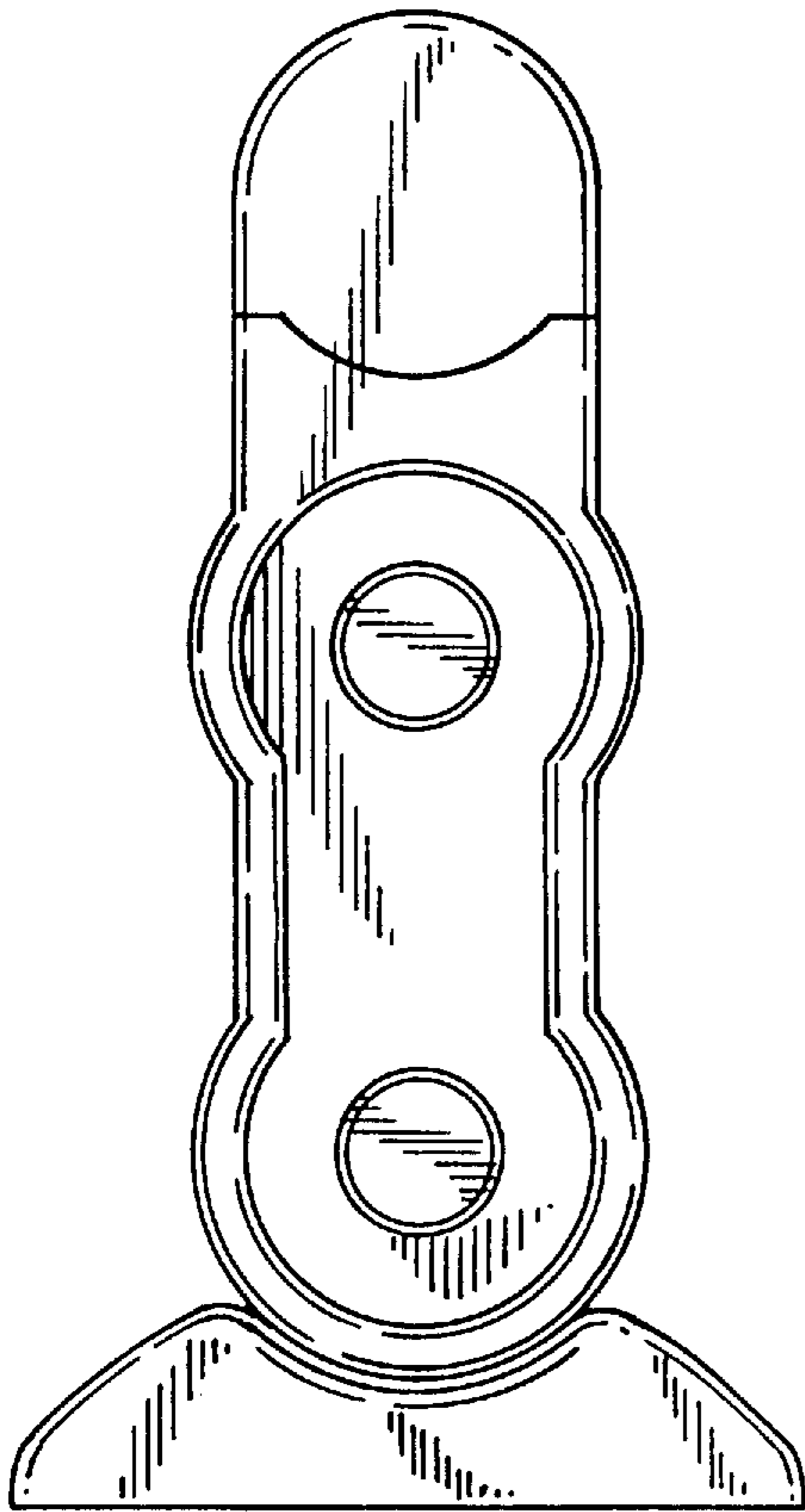

FIG. 6

