



US00D399134S

United States Patent [19]

[11] Patent Number: Des. 399,134

Lidle, Jr.

[45] Date of Patent: **Oct. 6, 1998

[54] PACKAGE FOR PAINT

[75] Inventor: Harry J. Lidle, Jr., Macungie, Pa.

[73] Assignee: Binney & Smith Inc., Easton, Pa.

[**] Term: 14 Years

[21] Appl. No.: 80,663

[22] Filed: Sep. 5, 1997

[51] LOC (6) Cl. 09-07

[52] U.S. Cl. D9/346; D9/415

[58] Field of Search D9/341-347, 337, D9/339, 415, 418; 206/1.8, 1.9, 1.7, 461-471, 769, 770, 495, 575, 81; D19/35, 36

[56] References Cited

U.S. PATENT DOCUMENTS

D. 297,914	10/1988	Goodman	D9/341
D. 365,984	1/1996	Hofmann	D9/415
718,296	1/1903	Adamson .		
924,865	6/1909	Wilson .		
1,205,779	11/1916	Peck .		
1,391,028	9/1921	Werntz .		
1,835,884	12/1931	Lindsey	206/1.8
2,071,169	2/1937	Killik .		
2,165,345	7/1939	Conway, Jr. et al. .		
2,221,191	11/1940	James	206/1.8 X
3,089,584	5/1963	King .		
3,271,091	9/1966	Henry .		
3,389,945	6/1968	Thomas .		
3,786,913	1/1974	Crawford .		
3,856,136	12/1974	Governale .		
3,945,490	3/1976	Thompson .		
4,180,159	12/1979	Tanaka .		
4,619,364	10/1986	Czopor, Jr.	206/470 X
4,638,909	1/1987	Ford .		
4,708,817	11/1987	Dudnick .		
4,765,457	8/1988	Rayhle	206/1.7 X
4,901,850	2/1990	McIntosh .		
5,074,239	12/1991	Law .		
5,234,108	8/1993	Jorgensen .		
5,257,721	11/1993	Smith et al. .		
5,318,171	6/1994	Szekely .		
5,325,958	7/1994	Arasim	206/1.8
5,549,204	8/1996	Toren	206/470 X

OTHER PUBLICATIONS

Photocopies and photographs of Crayola Washable Water Colors (16 colors), Binney & Smith Inc., Easton, PA, the white paint tray was first sold in approximately Dec. 1996, the container package was first sold in approximately 1977. Photocopies and photographs of Crayola Water Colors (7 whole pans), Binney & Smith Inc., Easton, PA, first sold in approximately 1982.

Photocopies and photographs of Crayola Washable Water Colors (8 colors), Binney & Smith Inc., Easton, PA, the white paint tray was first sold in approximately Dec. 1996, the container package was first sold in approximately 1977. Photocopies and photographs of Crayola Water Colors (16 half pans), Binney & Smith Inc., Easton, PA, first sold in approximately 1982.

Photocopies and photographs of Child Guidance Water Colors (16 colors), Child Guidance a div. Of Azrak-Hamway Int'l Inc., NY, NY, ©1995.

Photocopies and Photographs of Futura Semi-Moist Water Colors (16 colors), MP316, Montrose Products, available to applicant in approximately Jan., 1996.

Primary Examiner—Prabhakar G. Deshmukh
Attorney, Agent, or Firm—Leydig, Voit & Mayer, Ltd.

[57] CLAIM

The ornamental design for package for paint, as shown and described.

DESCRIPTION

FIG. 1 is a perspective view of the package for paint with the lid in the closed position;
FIG. 2 is a perspective view thereof with the lid in the open position;
FIG. 3 is a top view thereof with the lid in the closed position;
FIG. 4 is a top view thereof with the lid in the open position;
FIG. 5 is a left side view thereof;
FIG. 6 is a right side view thereof;
FIG. 7 is a front view thereof;
FIG. 8 is a rear view thereof; and,
FIG. 9 is a bottom view thereof.

1 Claim, 4 Drawing Sheets

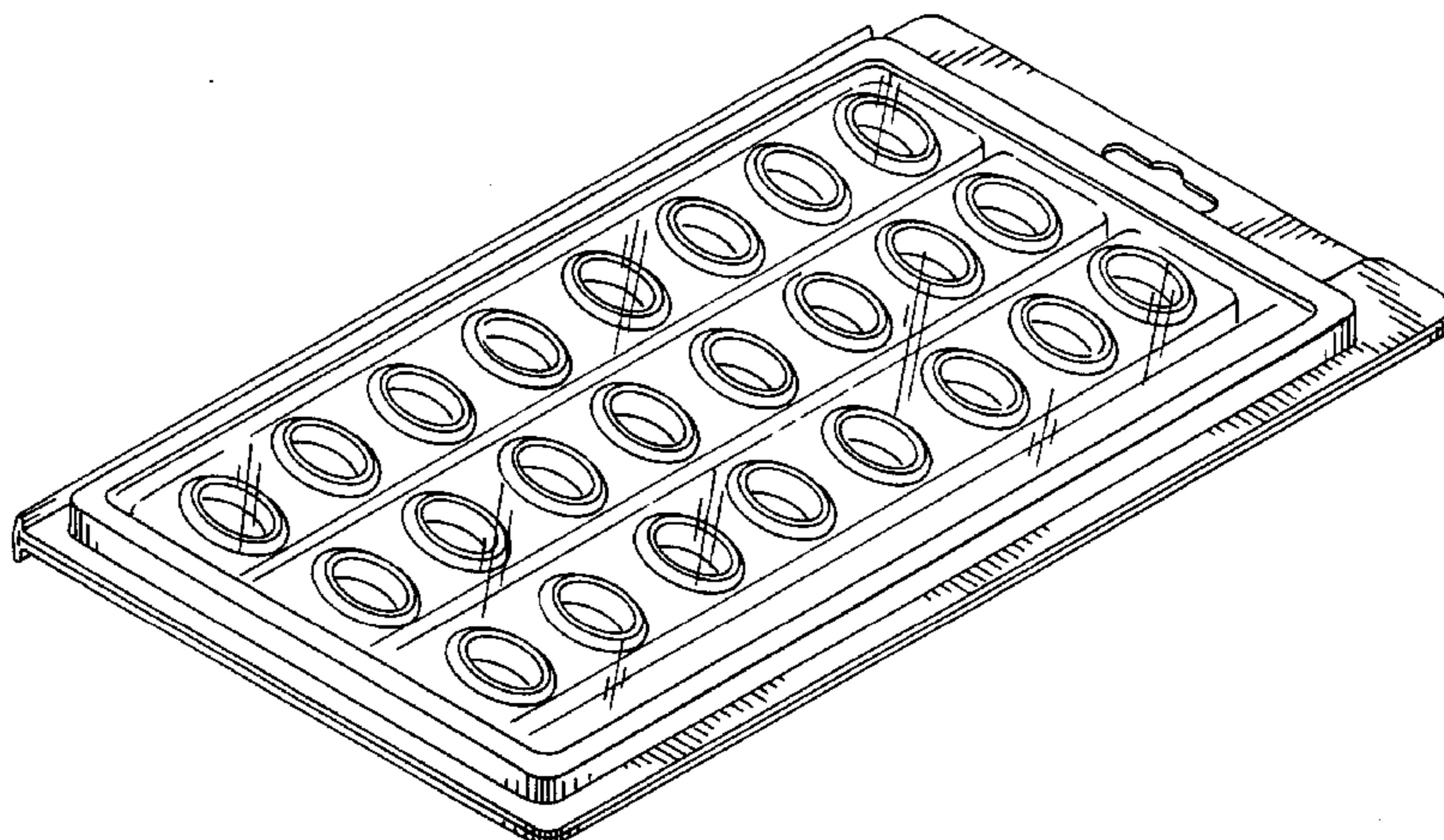

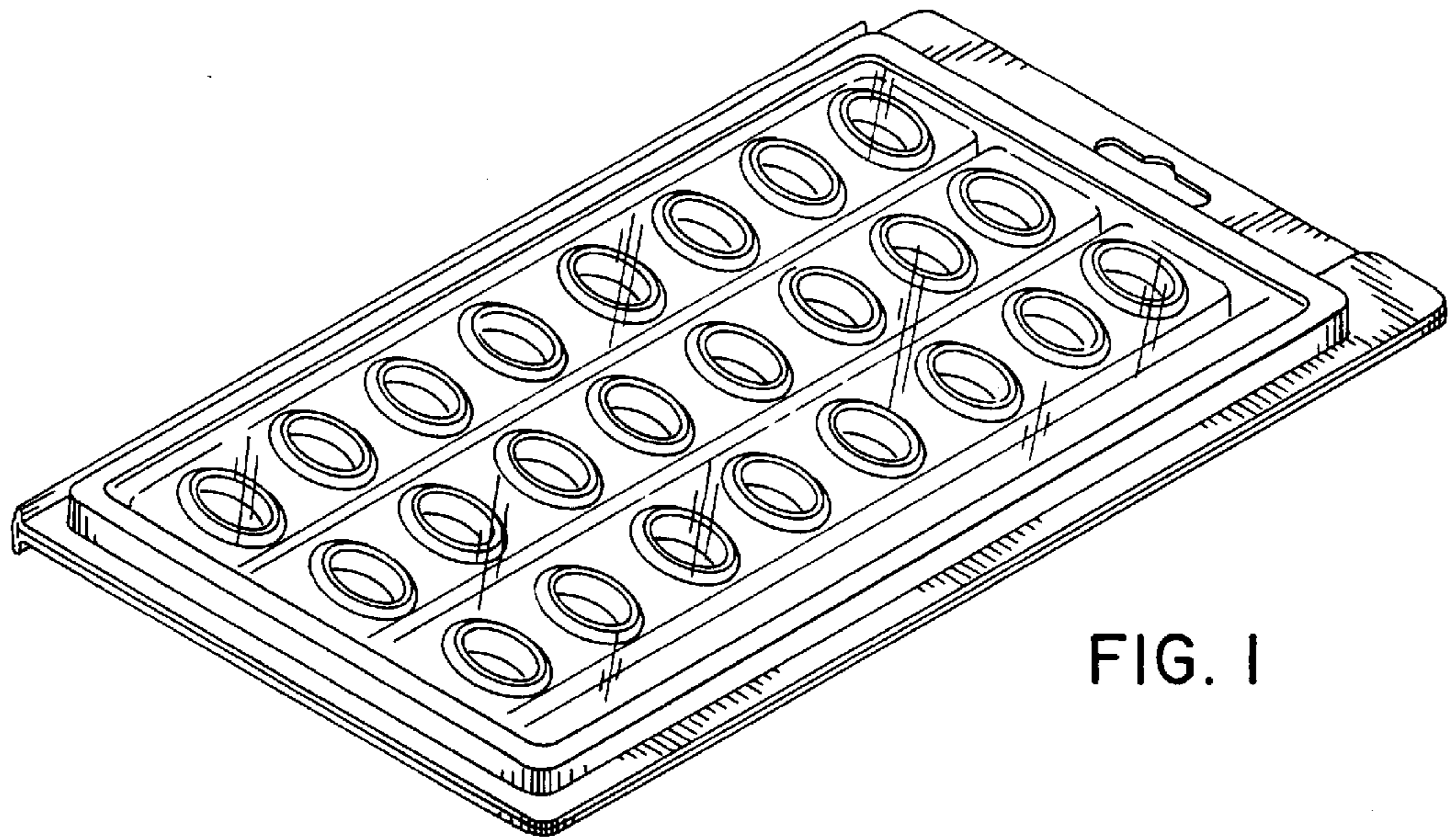

FIG. 1

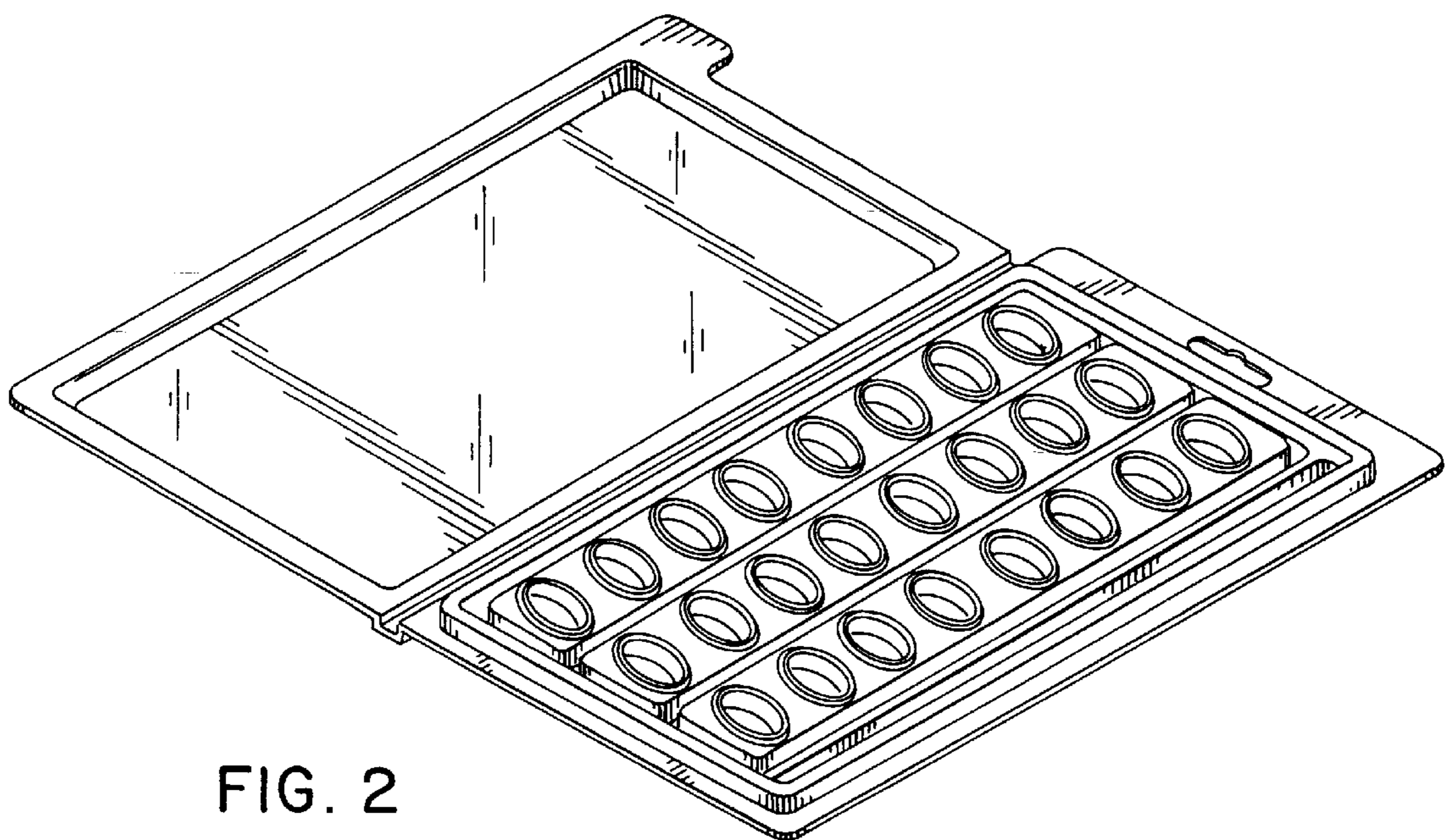

FIG. 2

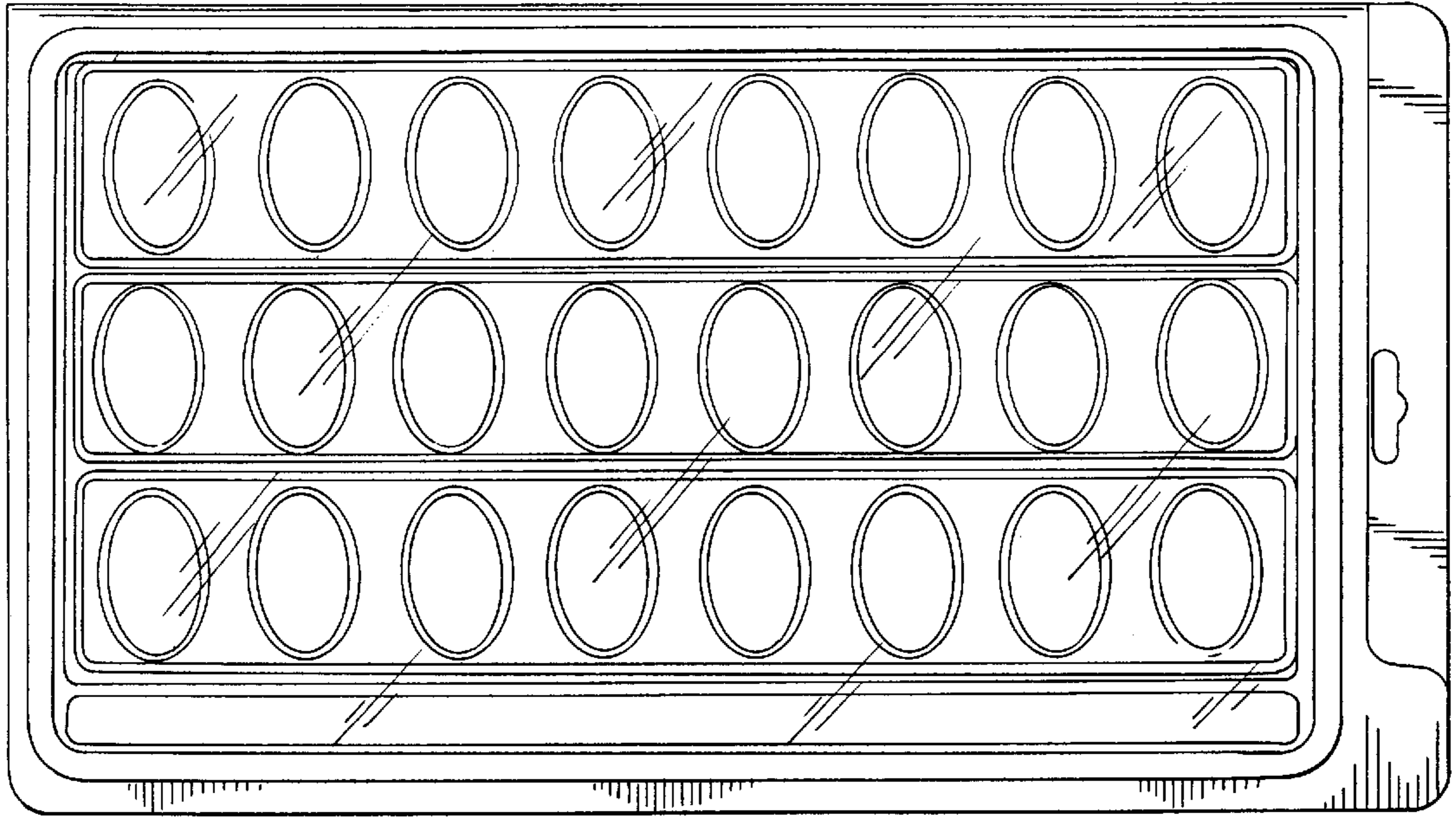

FIG. 3

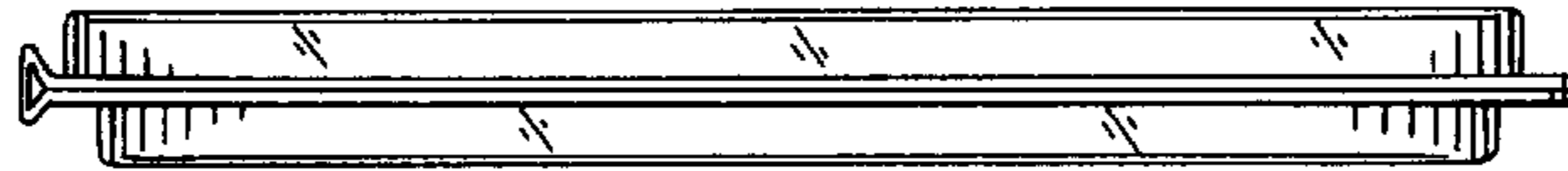

FIG. 5

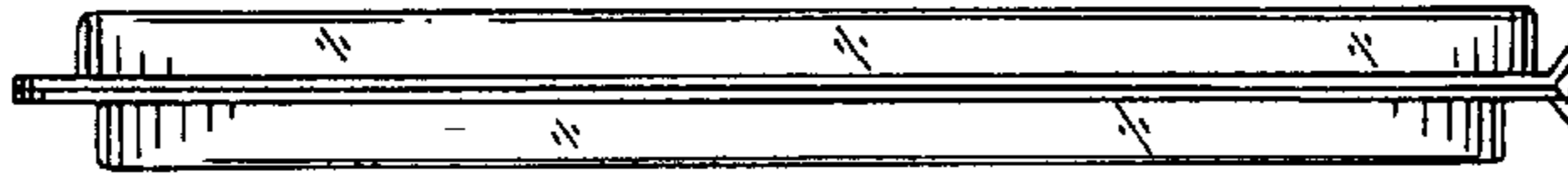

FIG. 6

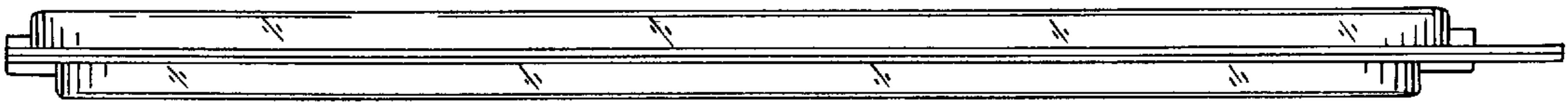
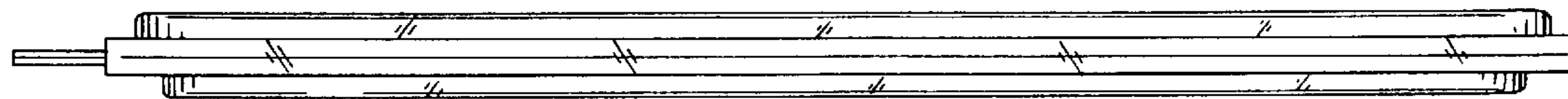

FIG. 7

FIG. 8



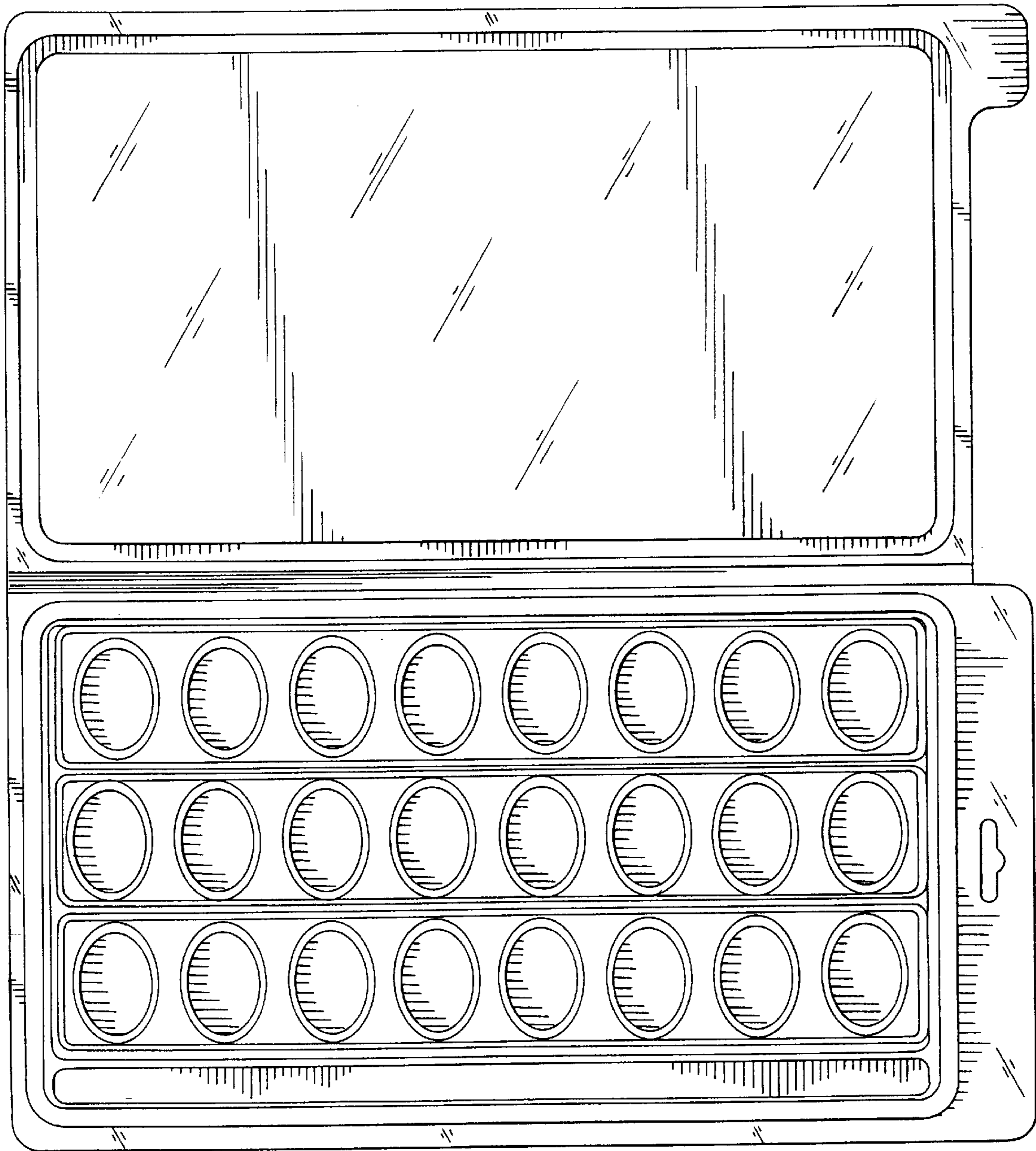

FIG. 4

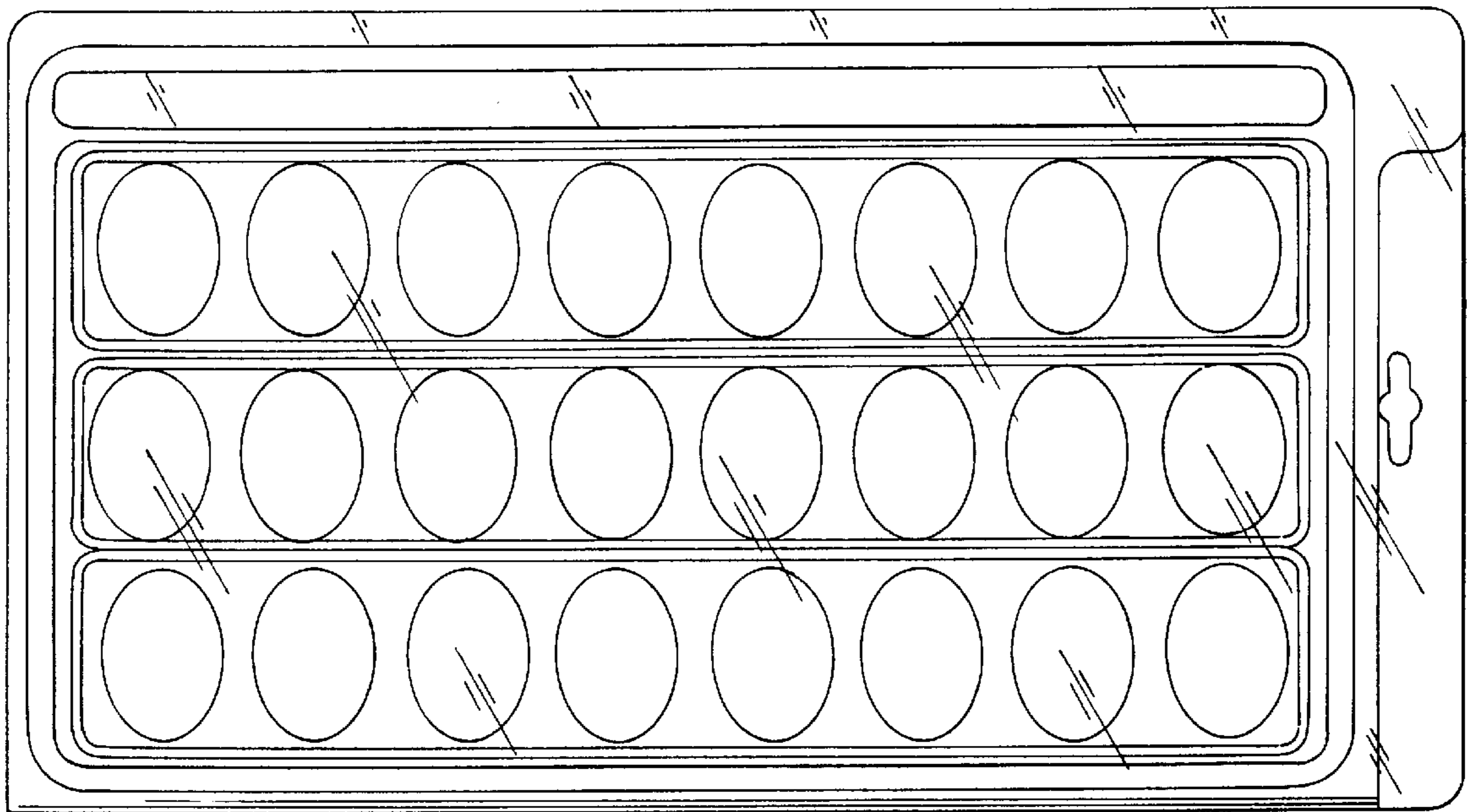

FIG. 9