



US00D399120S

United States Patent [19]
Costello

[11] **Patent Number: Des. 399,120**
[45] **Date of Patent: **Oct. 6, 1998**

[54] **SECURITY LOCK FOR WINDOW SASH**

4,223,930 9/1980 Costello 292/346
4,235,465 11/1980 Costello 292/346

[76] Inventor: **Michael Costello**, 18 Paris St., East
Boston, Mass. 02128

Primary Examiner—Brian N. Vinson
Attorney, Agent, or Firm—Morse & Altman; Gerald Altman

[**] Term: **14 Years**

[57] **CLAIM**

[21] Appl. No.: **63,741**

The ornamental design for security lock for window sash, as shown and described.

[22] Filed: **Dec. 13, 1996**

DESCRIPTION

[51] **LOC (6) Cl.** **08-07**

[52] **U.S. Cl.** **D8/338; D8/343**

[58] **Field of Search** D8/336, 338; 70/89,
70/90; 292/194, 240, 241, 242, 346

FIG. 1 is a top plan view of a security lock for window sash showing my new design;
FIG. 2 is a front elevational view thereof;
FIG. 3 is a right side elevational view thereof, the left side being a mirror image of that shown; and,
FIG. 4 is a bottom plan view thereof.

[56] **References Cited**

U.S. PATENT DOCUMENTS

D. 249,017	8/1978	Costello	D8/337
D. 268,643	4/1983	Anderson	D8/337
D. 293,548	1/1988	Bates et al.	D8/337
D. 350,275	9/1994	Olsen et al.	D8/338
4,102,546	7/1978	Costello	292/346

The rear is plain and un-ornamented, and the broken-line disclosure is for illustrative purposes only and forms no part of the claimed design.

1 Claim, 2 Drawing Sheets

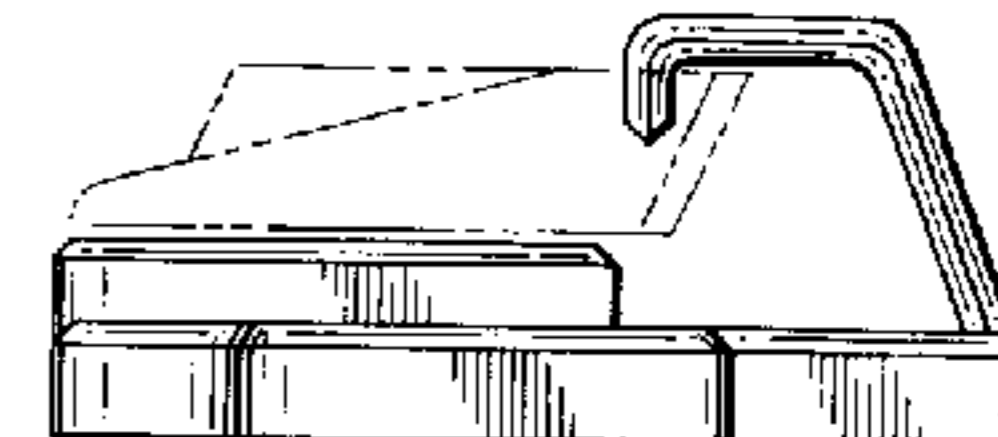
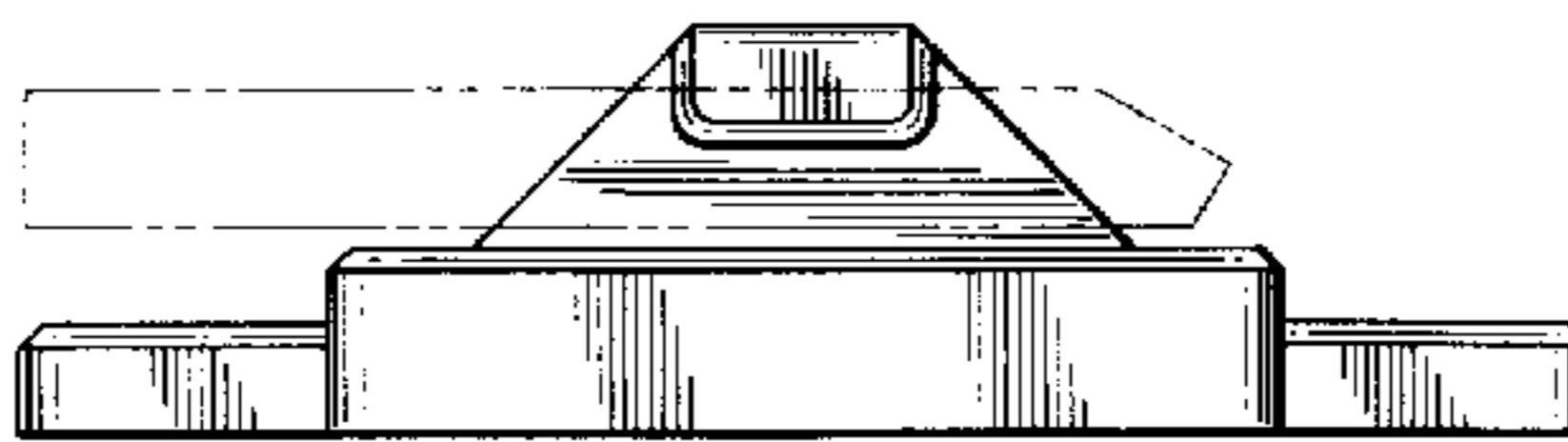
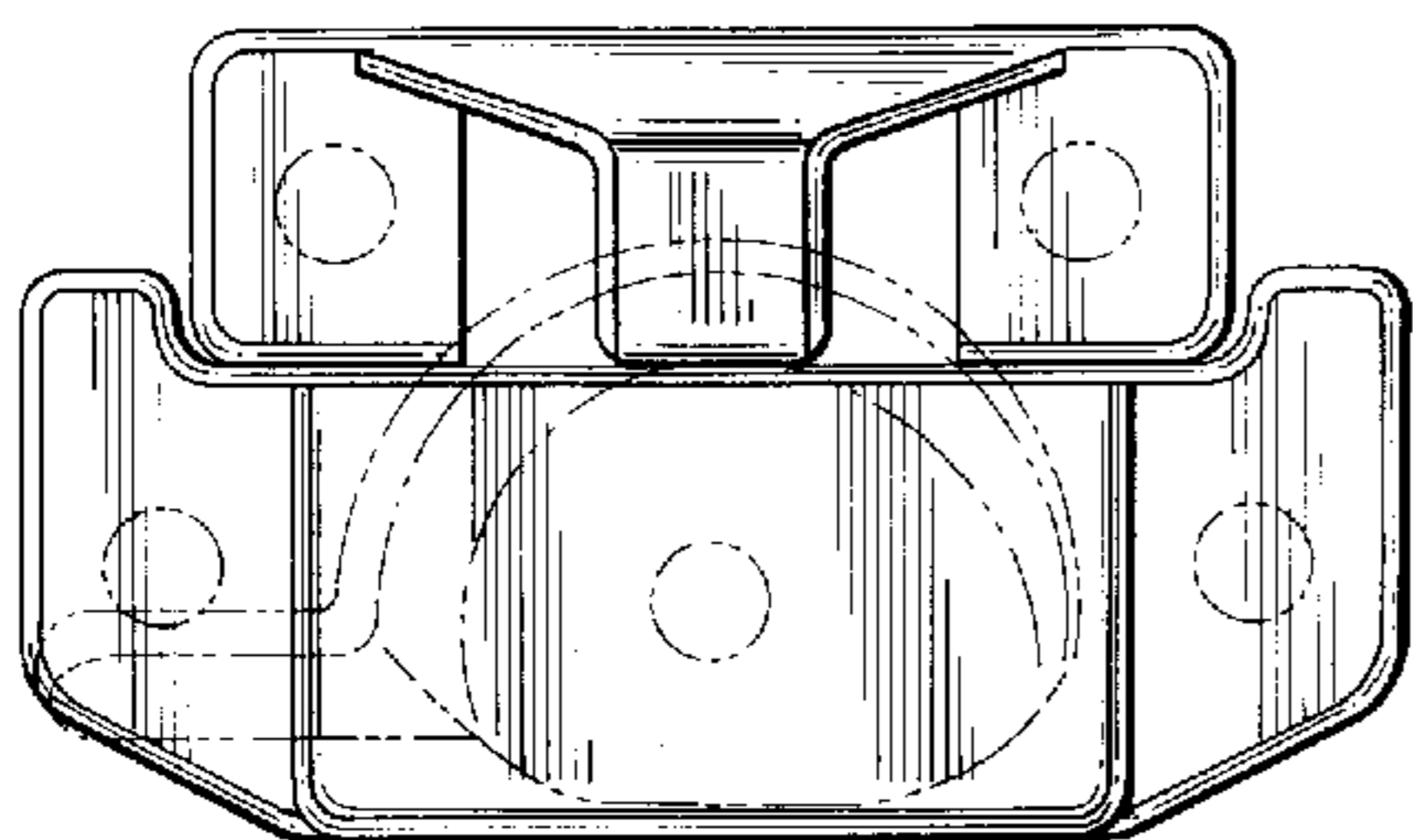

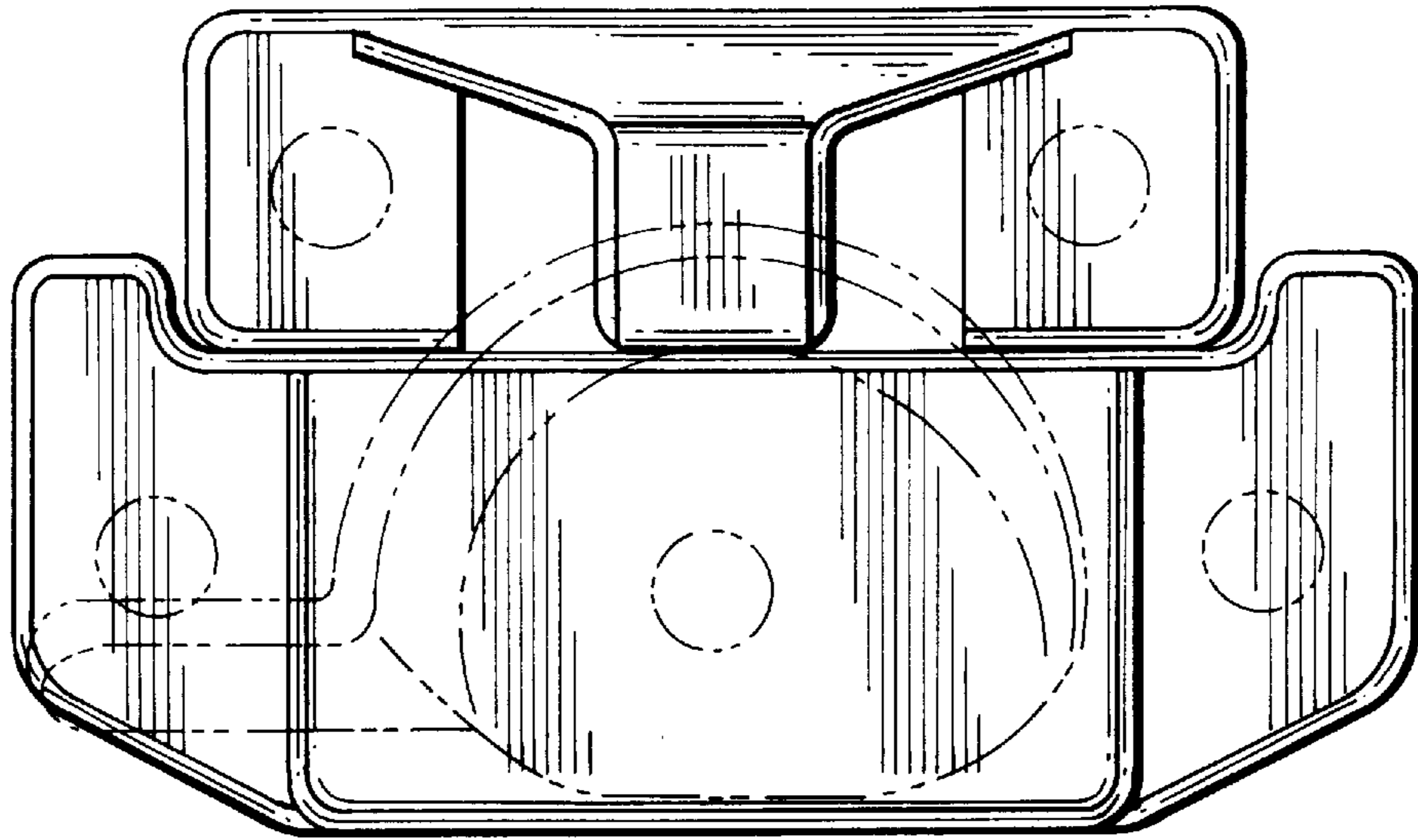

FIG. 1

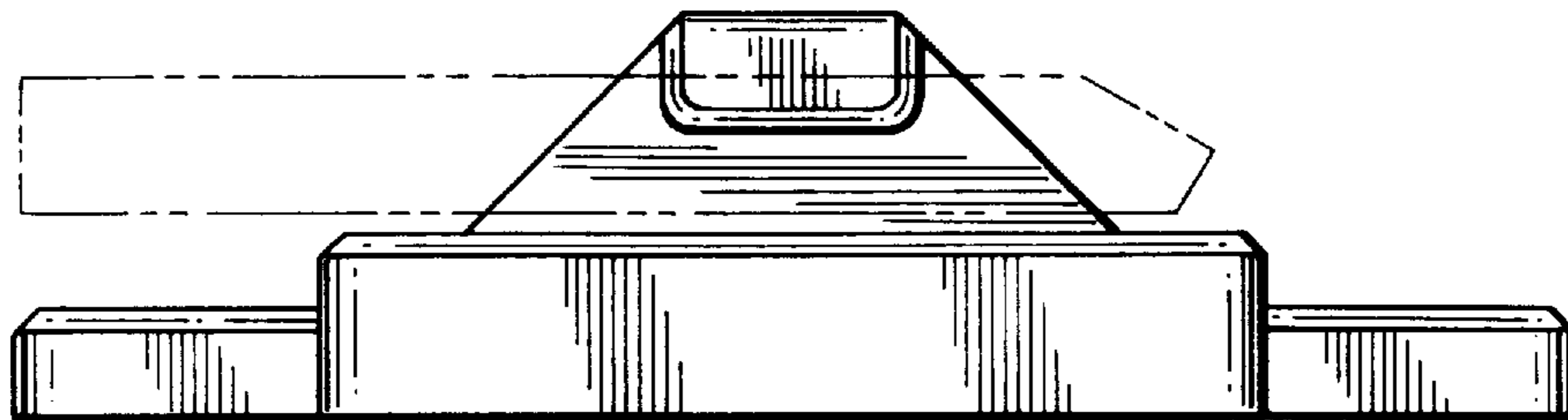

FIG. 2

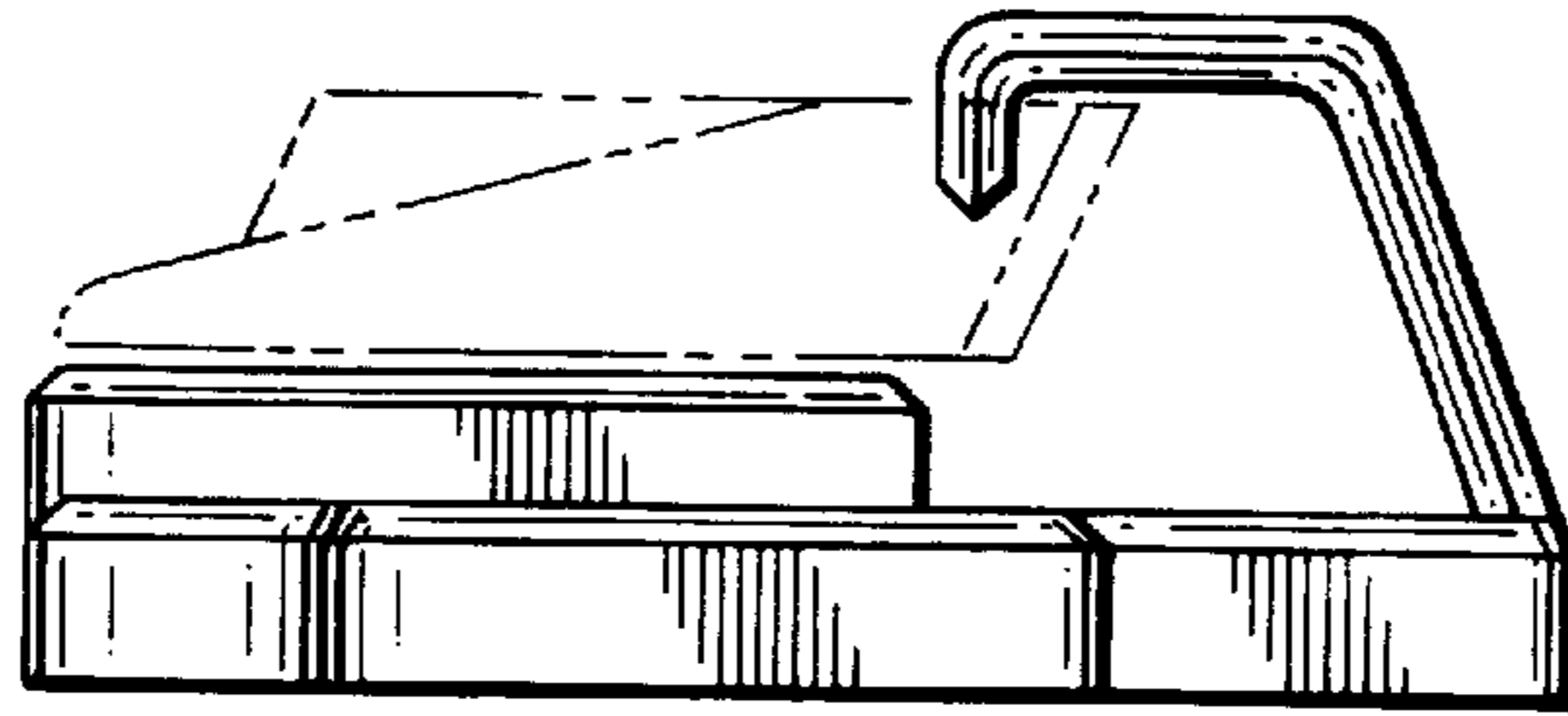

FIG. 3

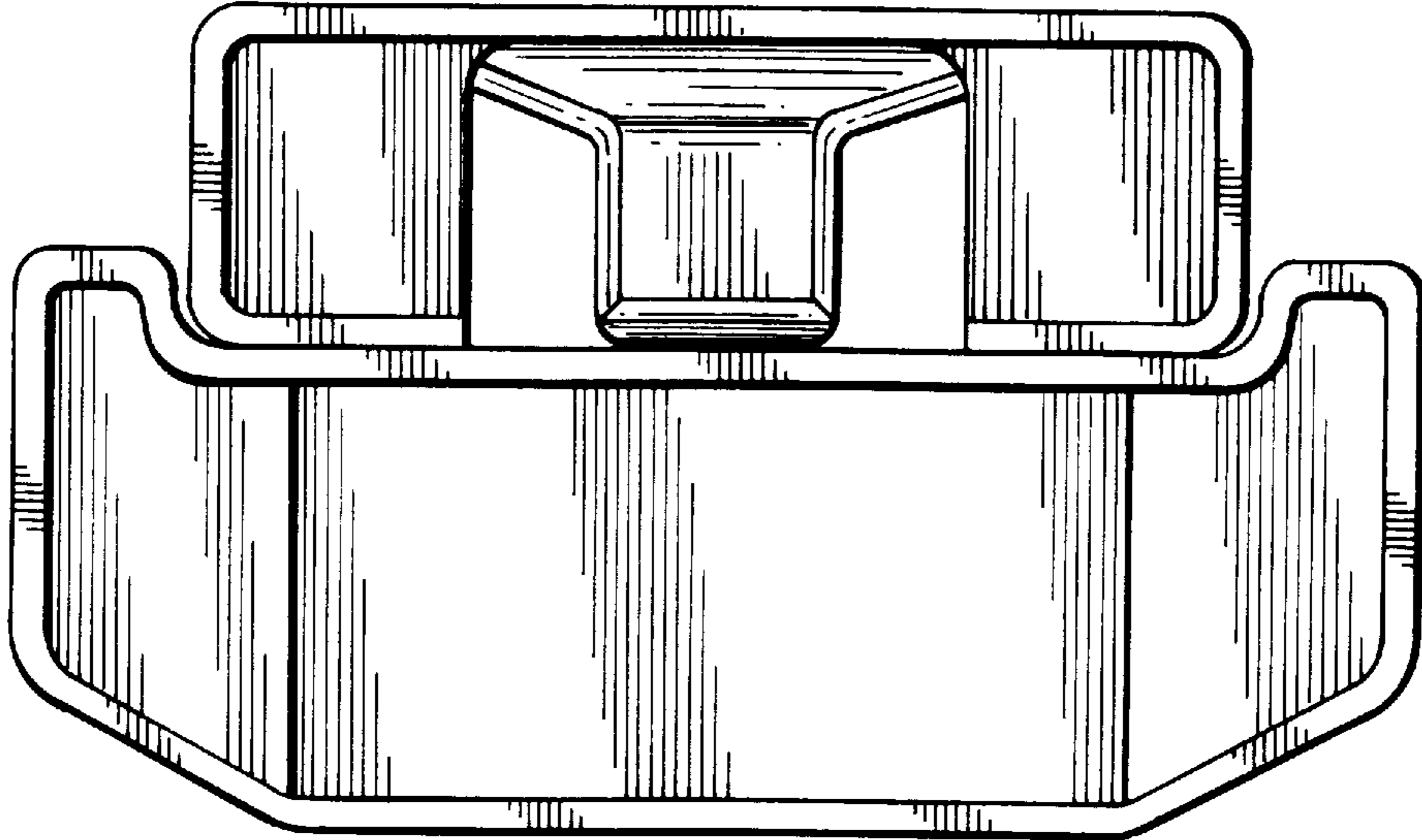

FIG. 4