



US00D398917S

United States Patent [19]

Senshiki

[11] **Patent Number: Des. 398,917**

[45] **Date of Patent: **Sep. 29, 1998**

[54] **FACSIMILE TRANSMITTER-RECEIVER
CAPABLE OF SERVING AS PHOTOCOPIER**

[75] Inventor: **Yasunori Senshiki**, Kunitachi, Japan

[73] Assignee: **Canon Kabushiki Kaisha**, Japan

[**] Term: **14 Years**

[21] Appl. No.: **78,373**

[22] Filed: **Oct. 22, 1997**

[30] **Foreign Application Priority Data**

Apr. 28, 1997 [JP] Japan 9-052697

[51] **LOC (6) Cl.** **16-03**

[52] **U.S. Cl.** **D14/118**

[58] **Field of Search** D14/118, 124,
D14/299; 358/400, 401; D18/36, 37

[56] **References Cited**

U.S. PATENT DOCUMENTS

- D. 363,713 10/1995 Kanari et al. D14/118
- D. 368,084 3/1996 Kaneko D14/118
- D. 377,370 1/1997 Escobedo et al. D14/118 X
- D. 385,267 10/1997 Omino D14/118

- D. 386,490 11/1997 Fujimoto D14/118
- 5,172,243 12/1992 Hayashi et al. 358/400
- 5,183,431 2/1993 Todokoro D14/118 X
- 5,387,980 2/1995 Baitz et al. 358/408

OTHER PUBLICATIONS

Panasonic, Panafax, front page, Jun. 1994.

Primary Examiner—Prabhakar G. Deshmukh
Attorney, Agent, or Firm—Fitzpatrick, Cella, Harper & Scinto

[57] **CLAIM**

The ornamental design for a facsimile transmitter-receiver capable of serving as photocopier, as shown and described.

DESCRIPTION

FIG. 1 is a front view of a facsimile transmitter-receiver capable of serving as photocopier showing my new design; FIG. 2 is a rear view thereof; FIG. 3 is a top plan view thereof; FIG. 4 is a bottom plan view thereof; FIG. 5 is a left side view thereof; FIG. 6 is a right side view thereof; and, FIG. 7 is a perspective view thereof.

1 Claim, 5 Drawing Sheets

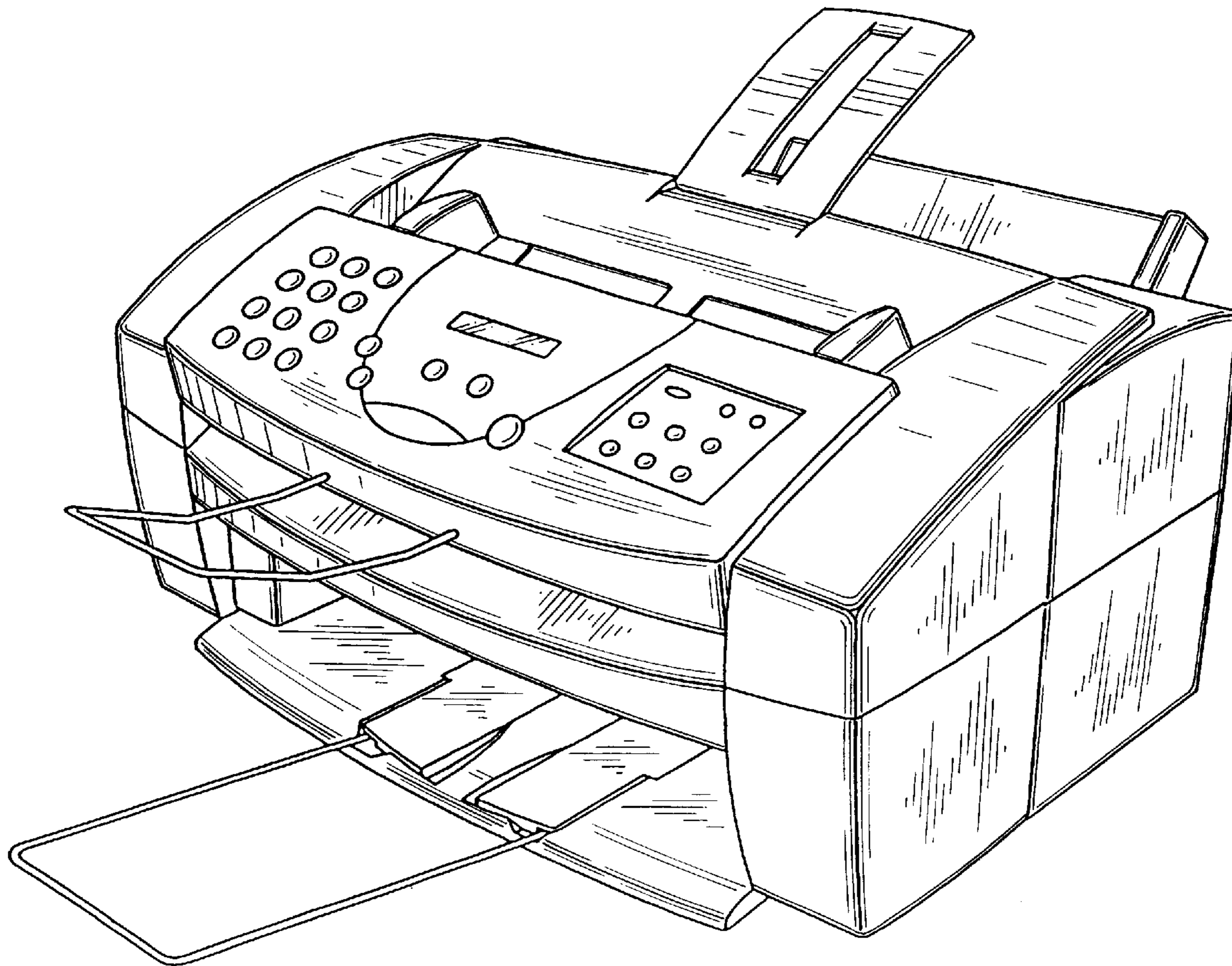

FIG. 1

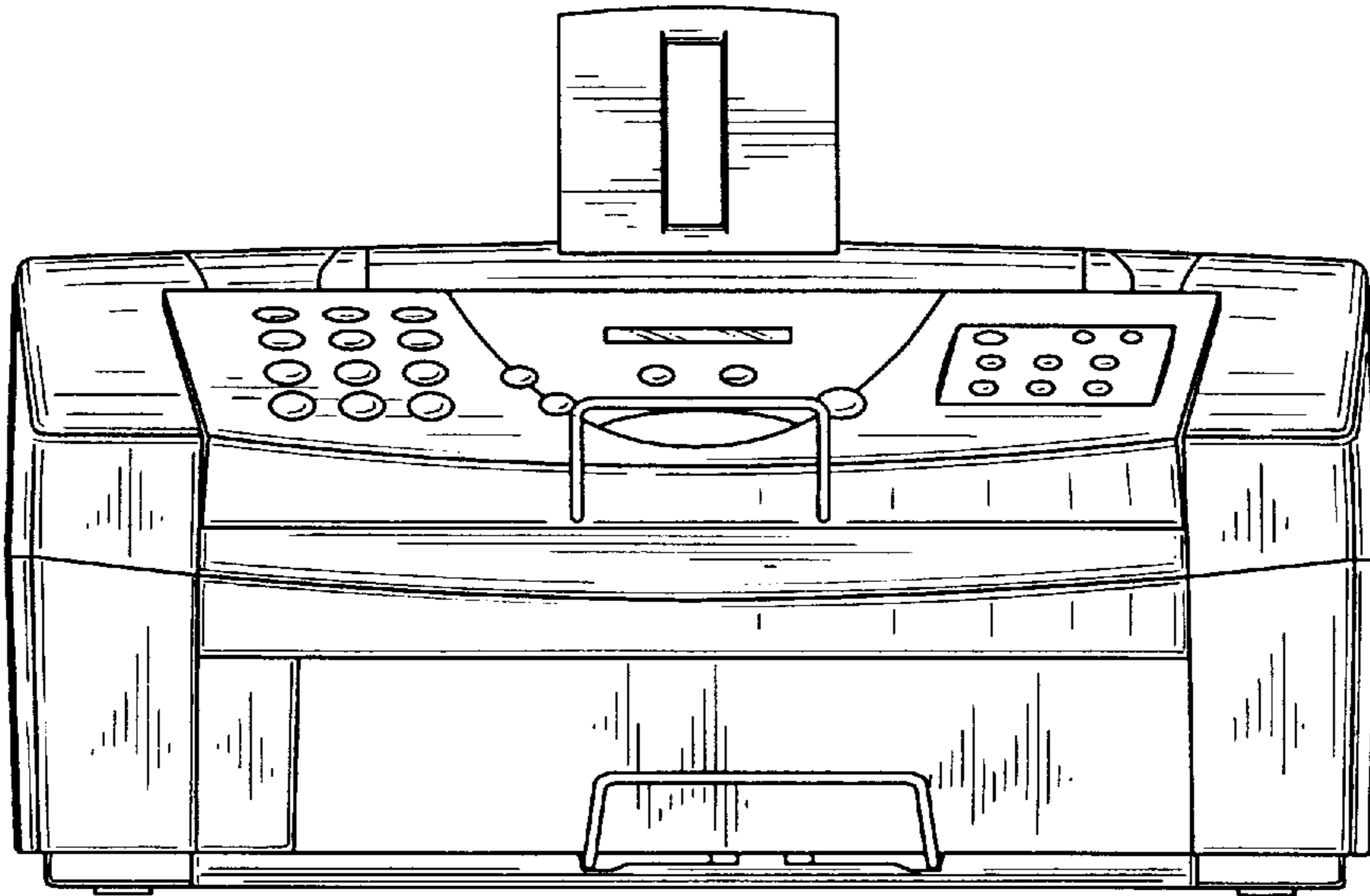

FIG. 2

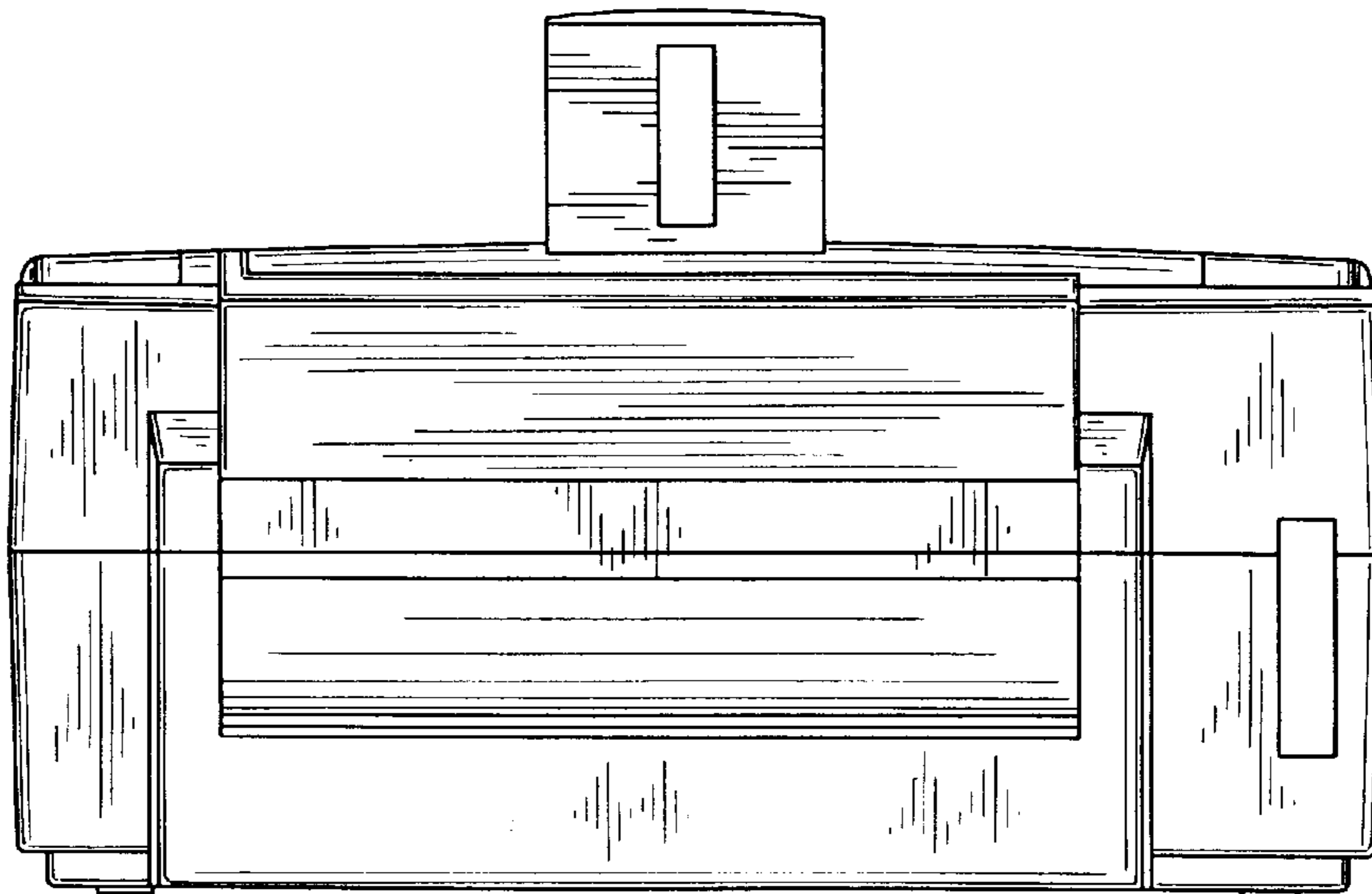

FIG. 3

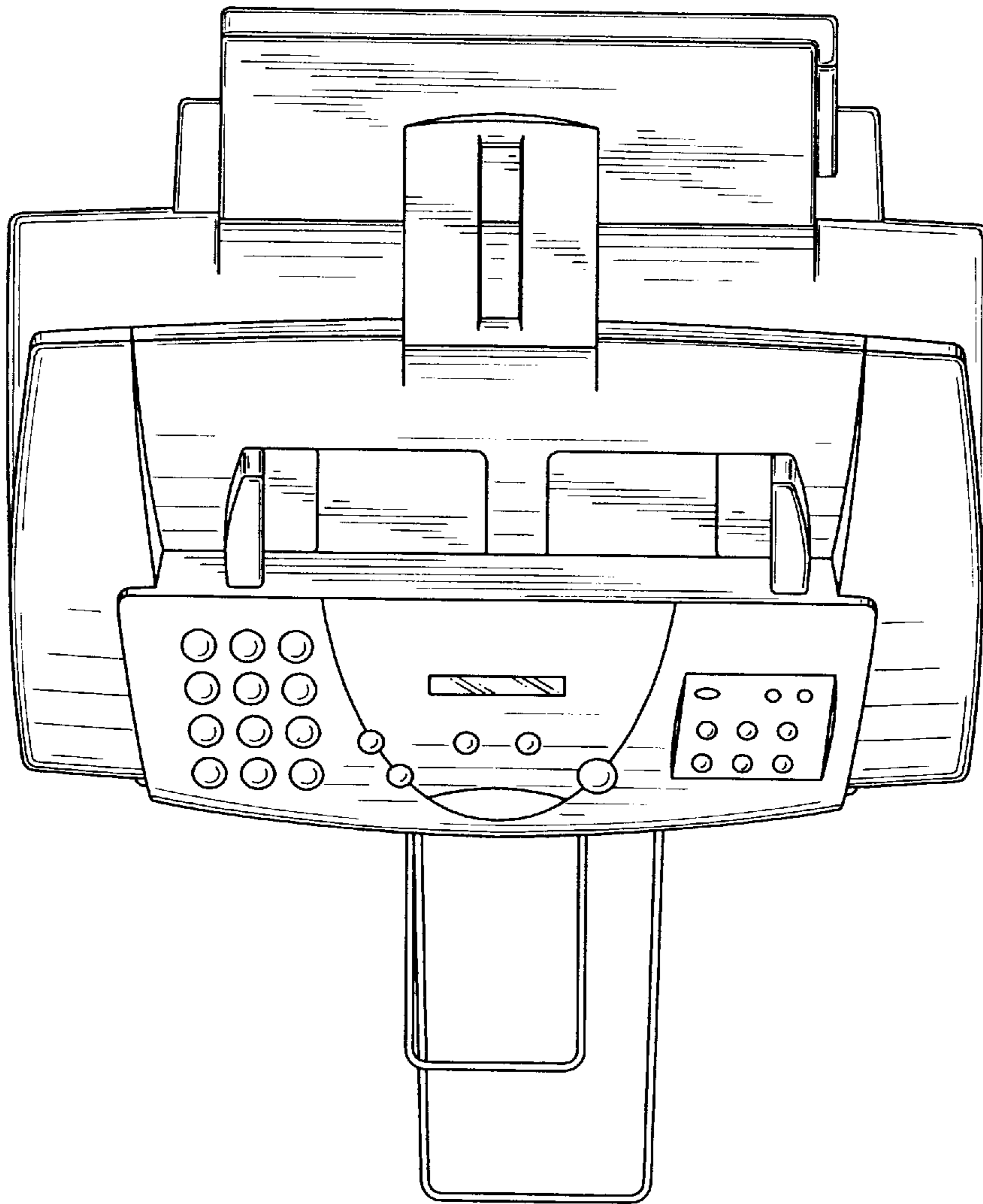

FIG. 4

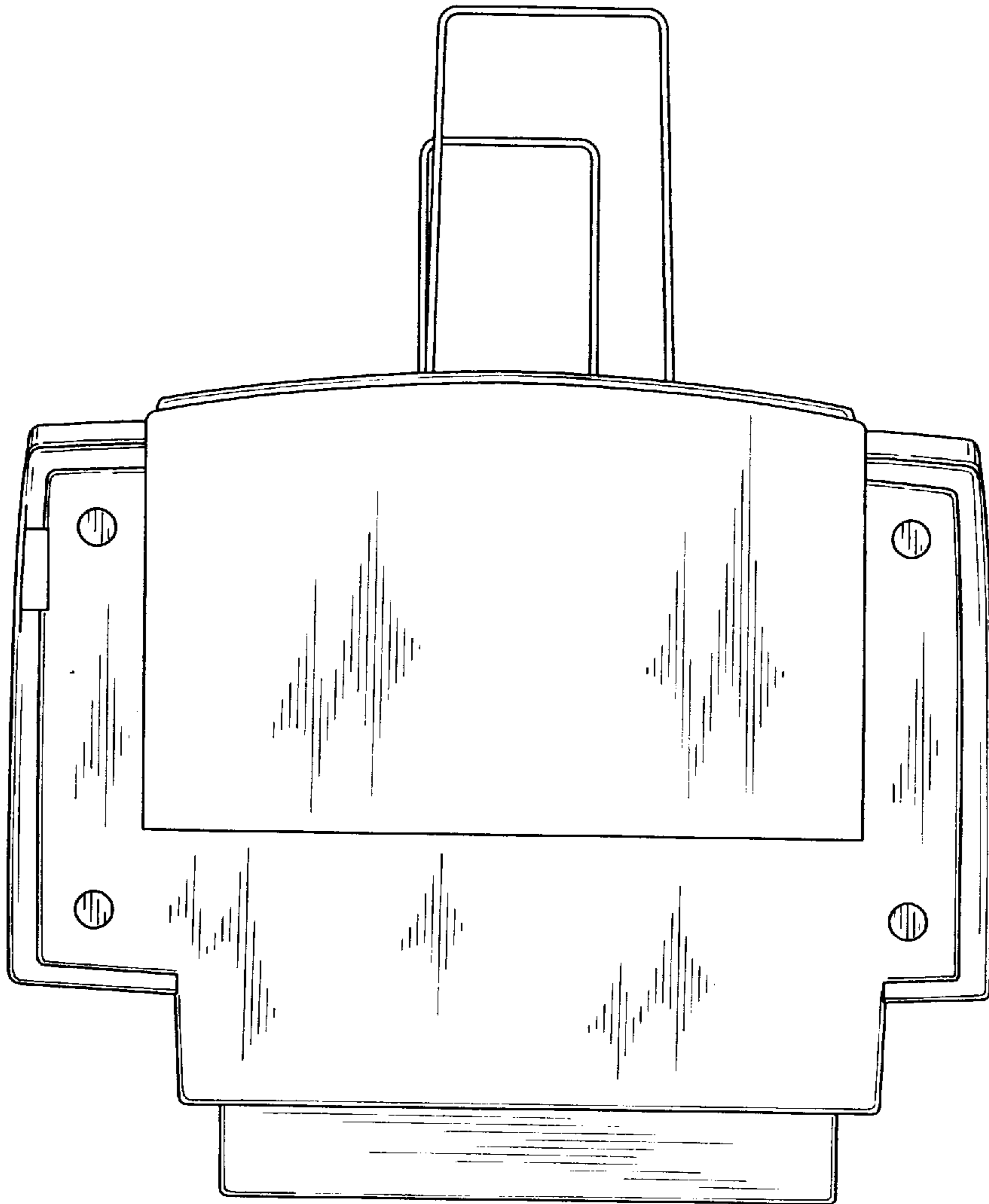

FIG. 5

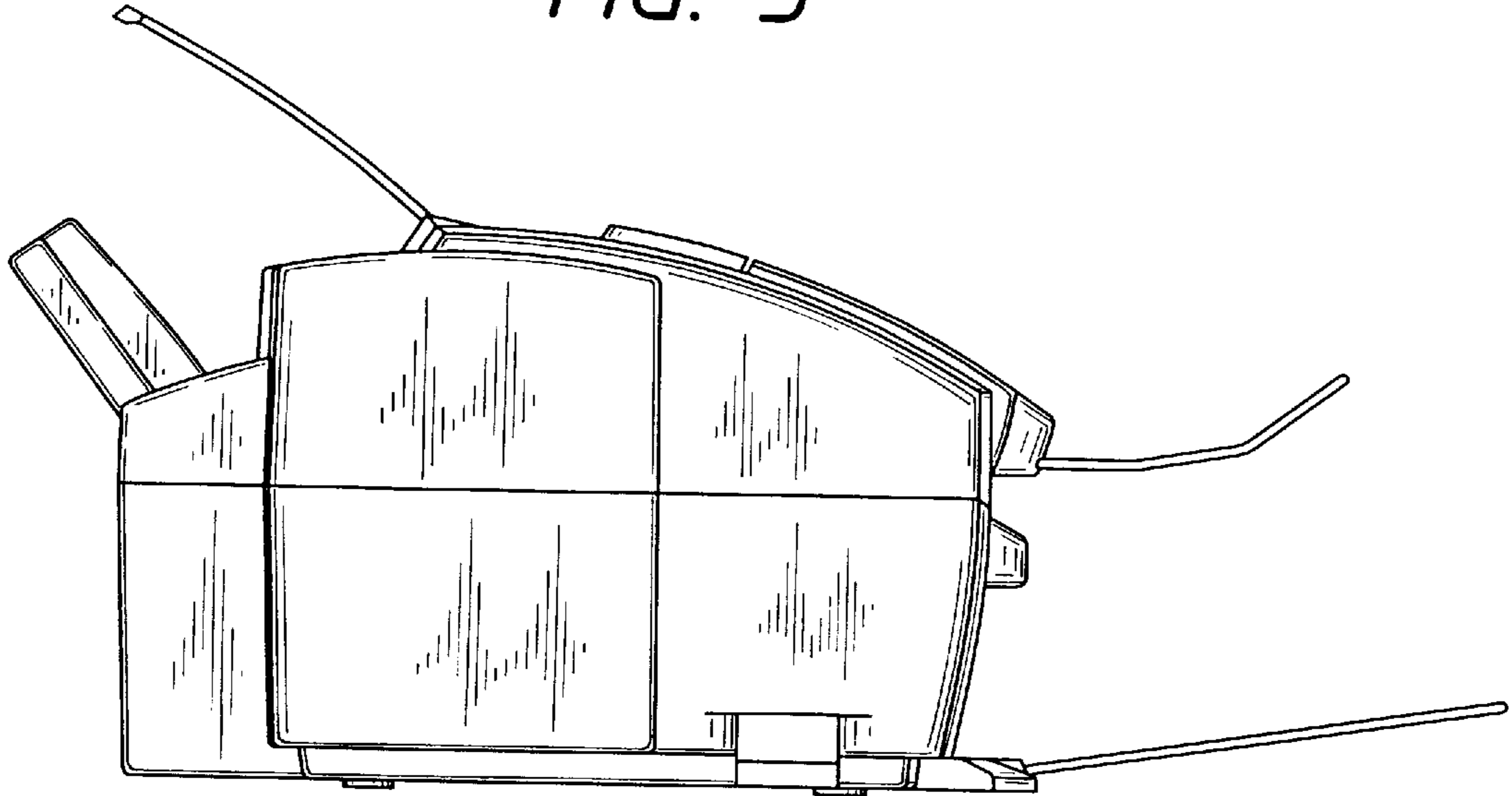

FIG. 6

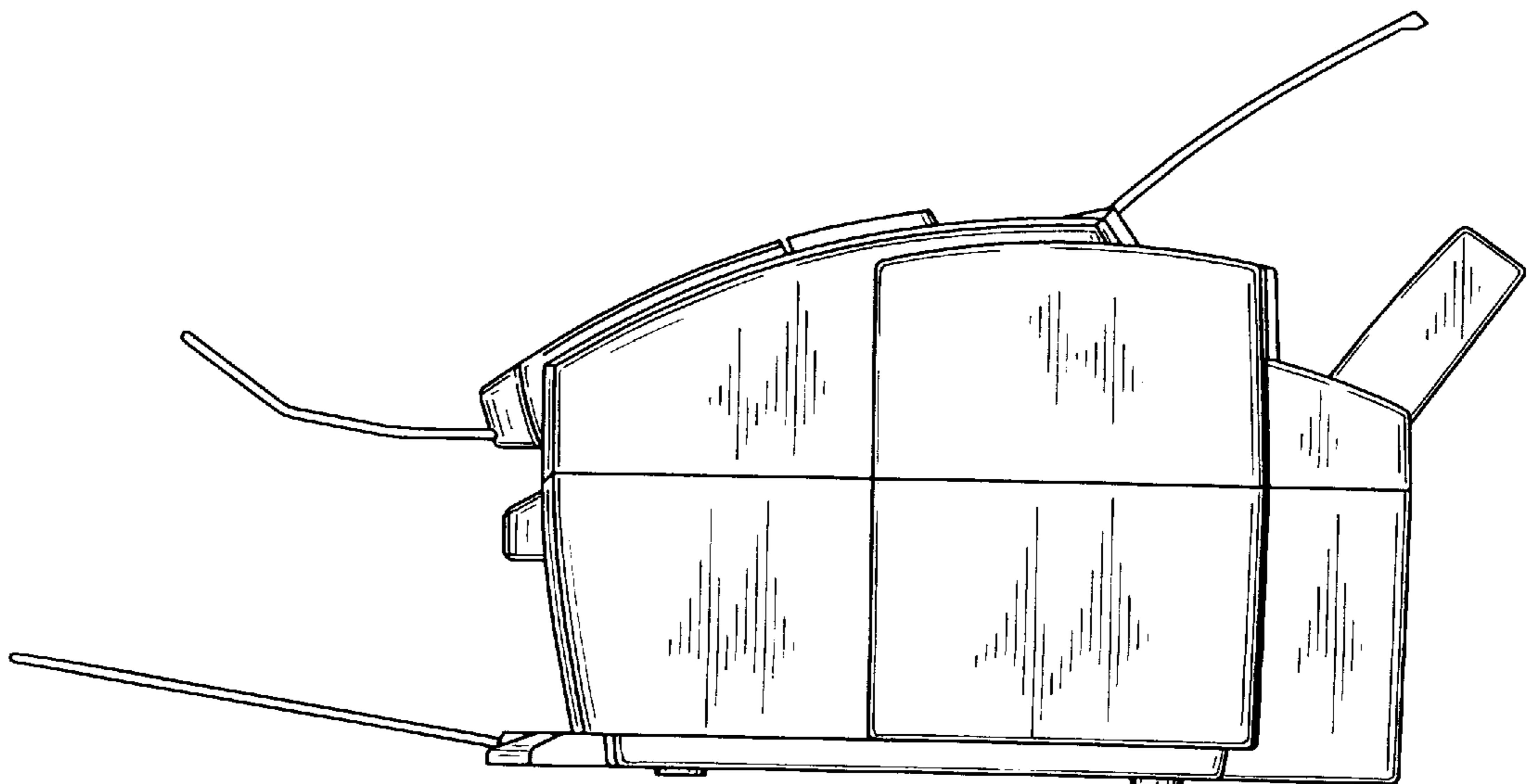

FIG. 7

