



US00D398802S

# United States Patent [19] Quinn

[11] **Patent Number: Des. 398,802**

[45] **Date of Patent: \*\*Sep. 29, 1998**

[54] **CHILD BOLSTER PILLOW FOR A CAR SEAT**

5,641,199 6/1997 Bond-Madsen ..... 297/229  
5,669,665 9/1997 Nowak ..... 5/922

[76] Inventor: **Rebecca C. Quinn**, 3946 Great Falls Hwy., Lancaster, S.C. 29720

[\*\*] Term: **14 Years**

[21] Appl. No.: **70,687**

[22] Filed: **May 13, 1997**

[51] **LOC (6) Cl. .... 06-09**

[52] **U.S. Cl. .... D6/601; D6/333; D6/596**

[58] **Field of Search .... D6/595-597, 601-604, D6/611; 5/630-633, 636-638, 652, 652.1, 653-655, 655.3, 656, 907; 297/219.1, 219.12, 226, 225, 229, 254, 250.1, 284.3, 284.5**

[56] **References Cited**

**U.S. PATENT DOCUMENTS**

D. 159,483	8/1950	Glassman .....	D6/604
D. 315,076	3/1991	Hanna .....	D6/601
4,175,786	11/1979	Schaller et al. .	
4,343,510	8/1982	Cone .	
4,376,551	3/1983	Cone .	
4,892,357	1/1990	Nieto-Busby et al. .	
5,248,182	9/1993	Hittie .	
5,332,285	7/1994	Sinnhuber .	

**FOREIGN PATENT DOCUMENTS**

660140	6/1965	Belgium .
1.433.601	2/1966	France .
44 02 962 A1	2/1965	Germany .

*Primary Examiner*—Janice E. Seeger  
*Attorney, Agent, or Firm*—Richard C. Litman

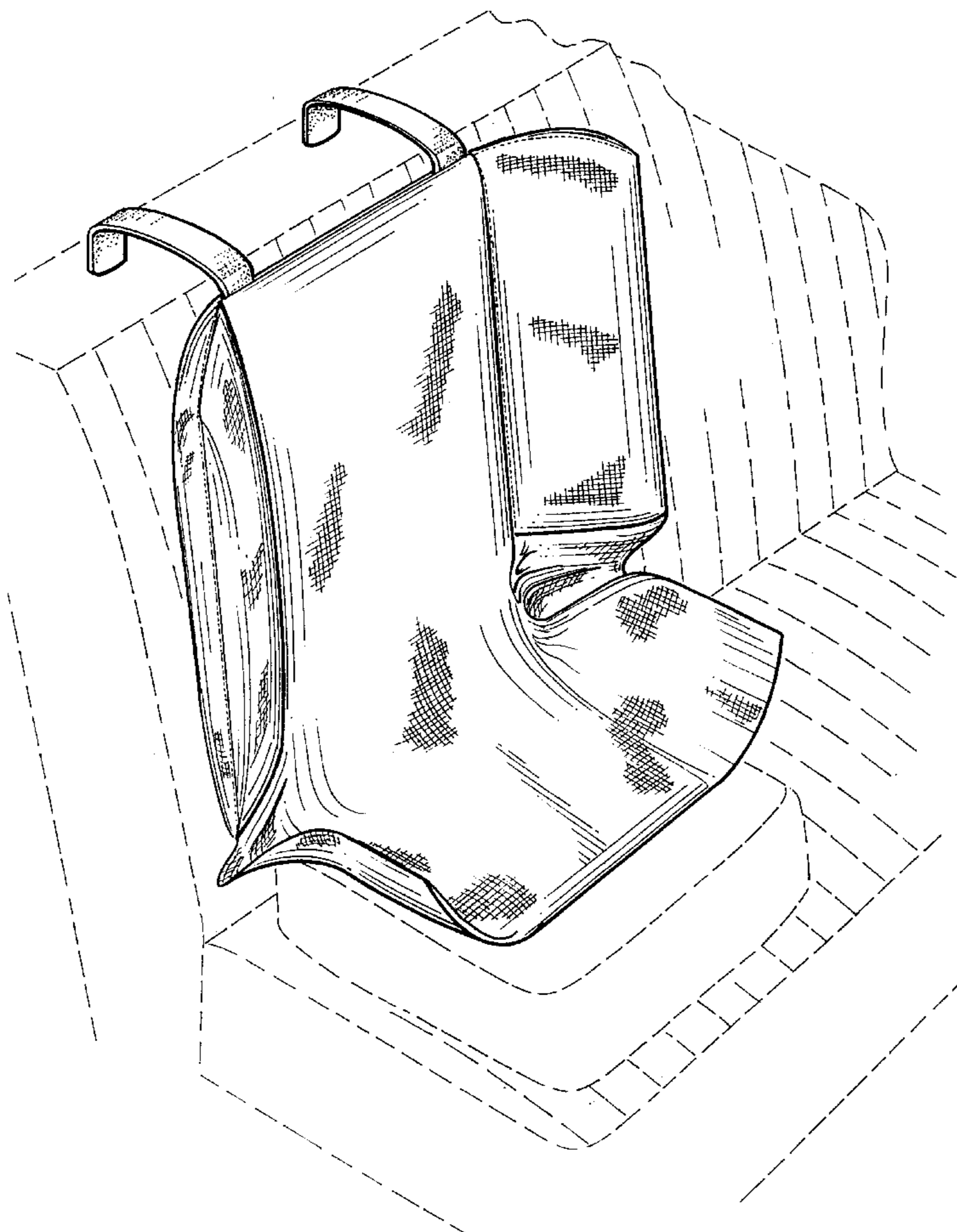
[57] **CLAIM**

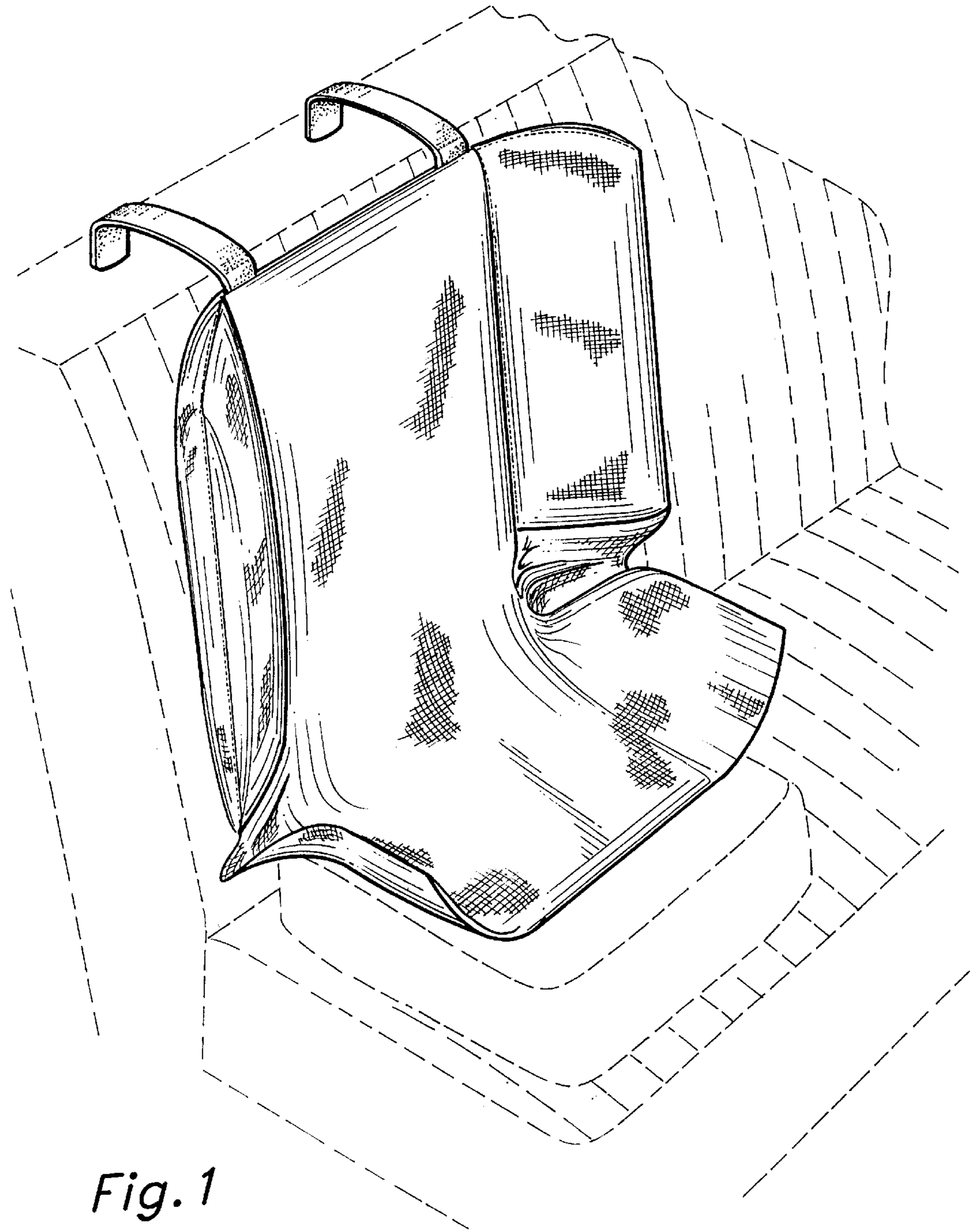
The ornamental design for a child bolster pillow for a car seat, as shown and described.

**DESCRIPTION**

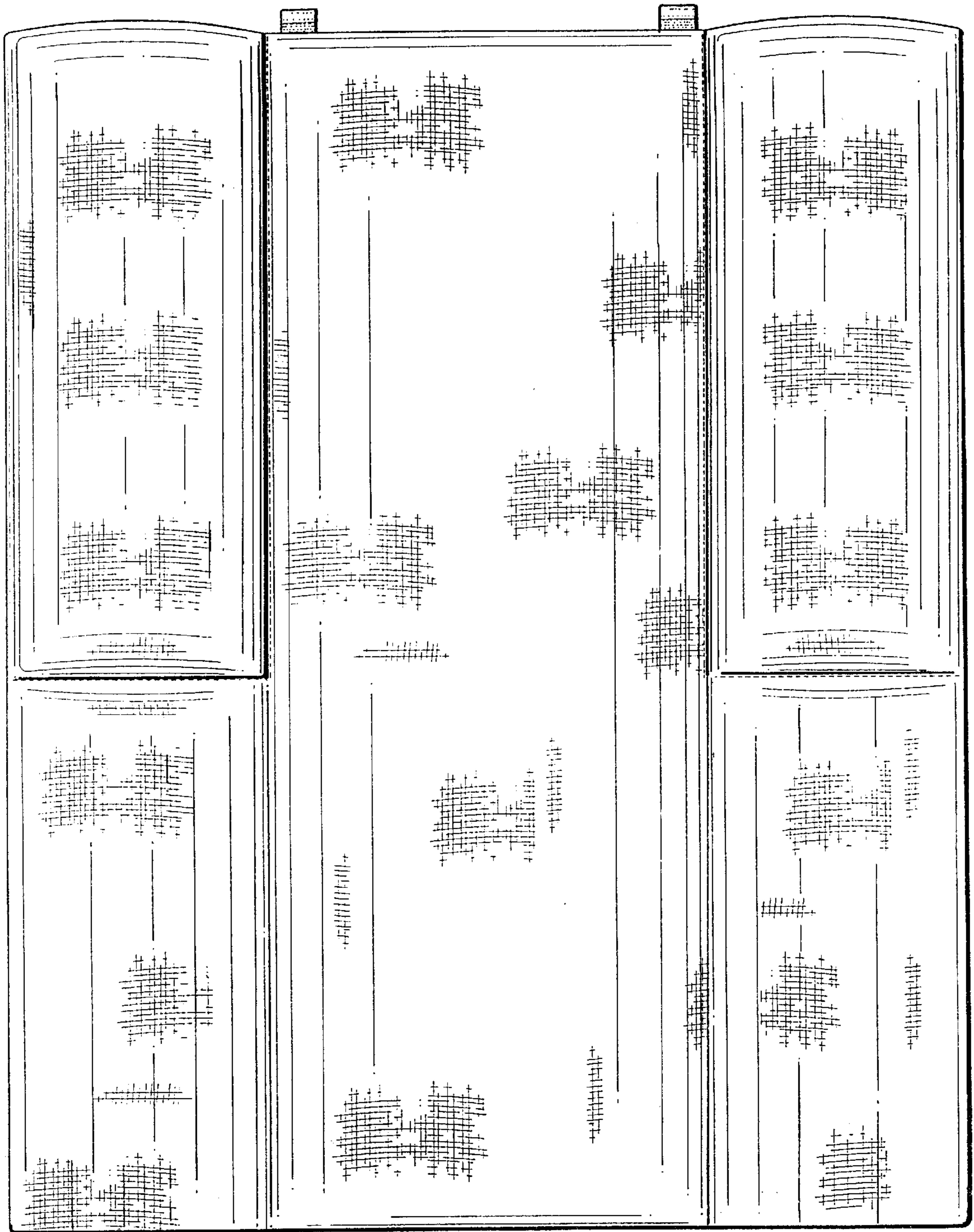
FIG. 1 is a perspective view of a child bolster pillow for a car seat, showing my new design in folded condition for use; the broken lines are for environmental purposes only and form no part of the claimed design;  
FIG. 2 is a front elevational view thereof;  
FIG. 3 is a left side elevational view with the right side being a mirror image thereof;  
FIG. 4 is a top view thereof;  
FIG. 5 is a bottom view thereof; and,  
FIG. 6 is a rear elevational view thereof;

**1 Claim, 5 Drawing Sheets**

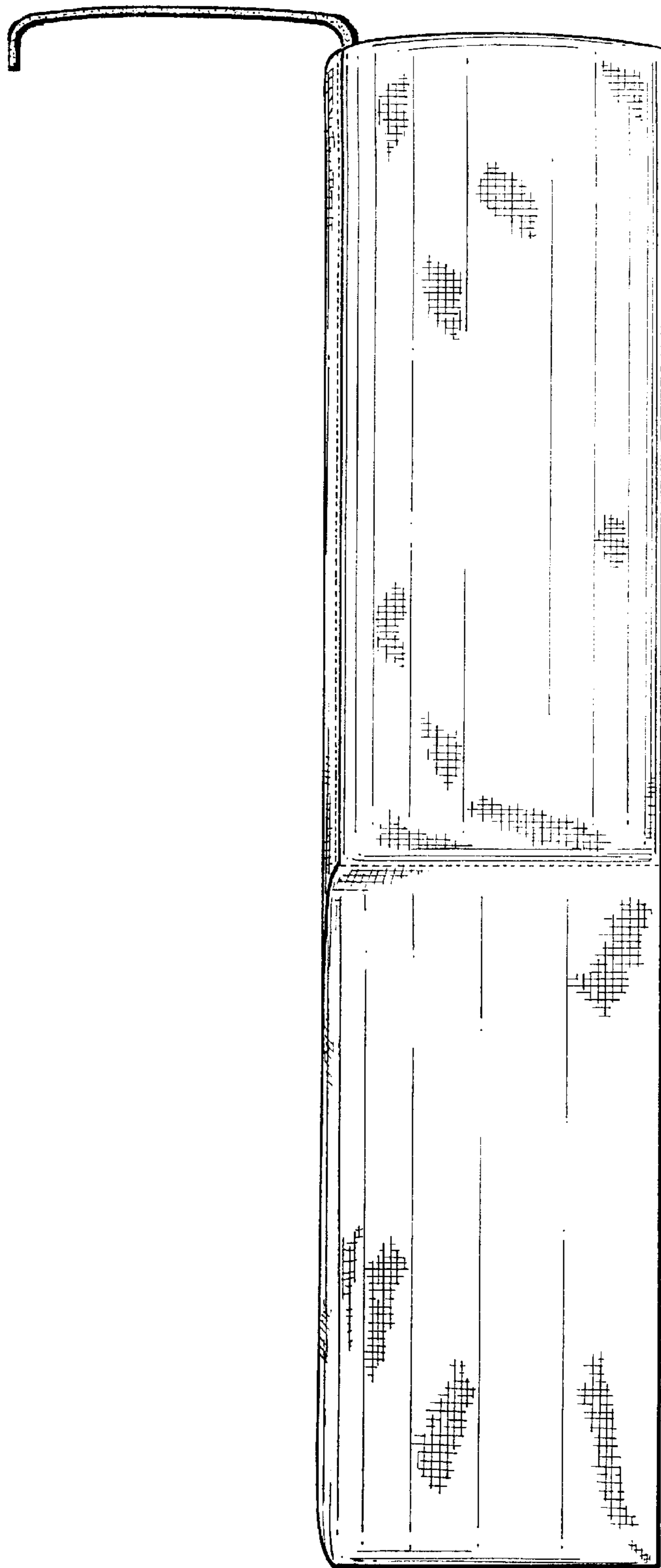




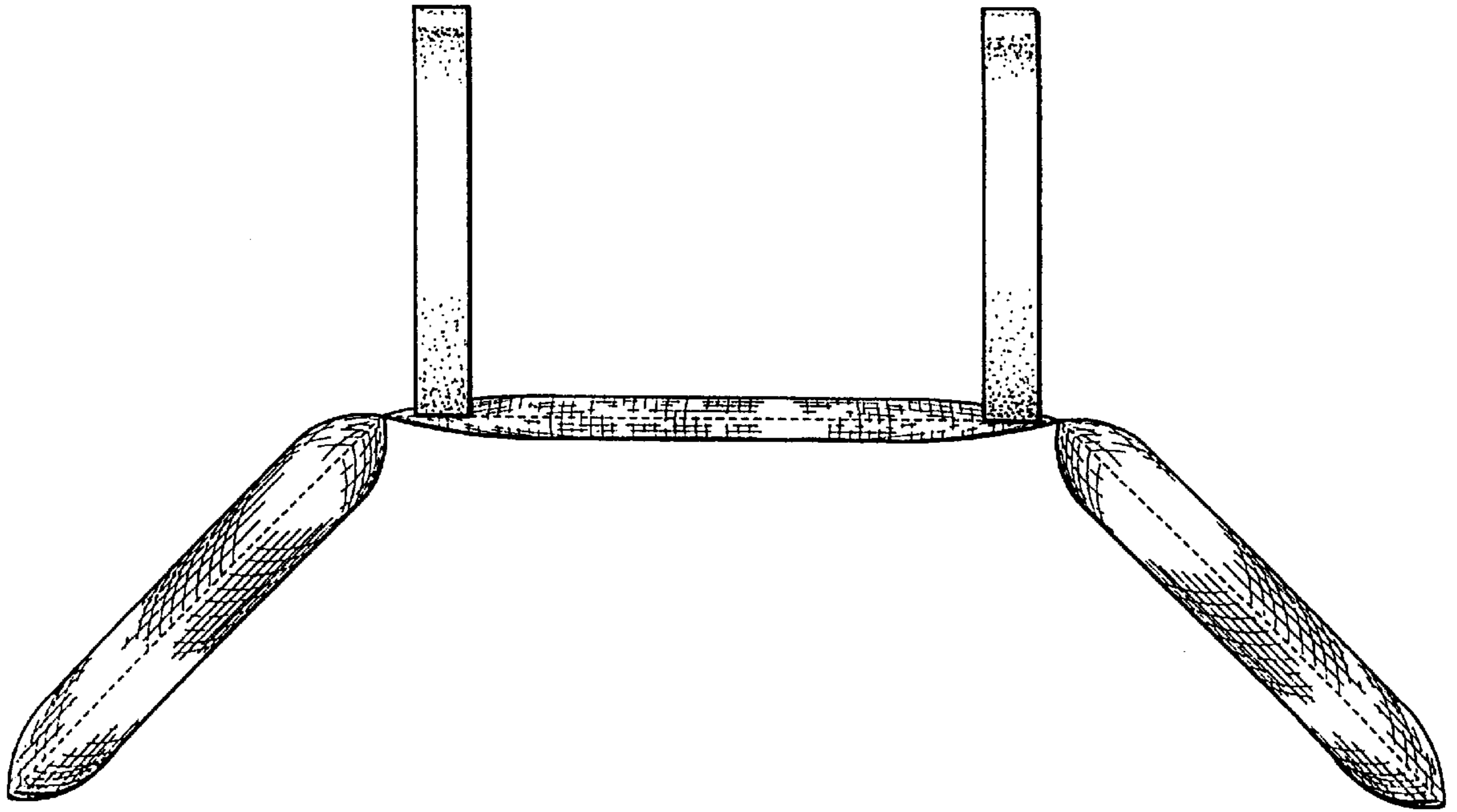
*Fig. 1*



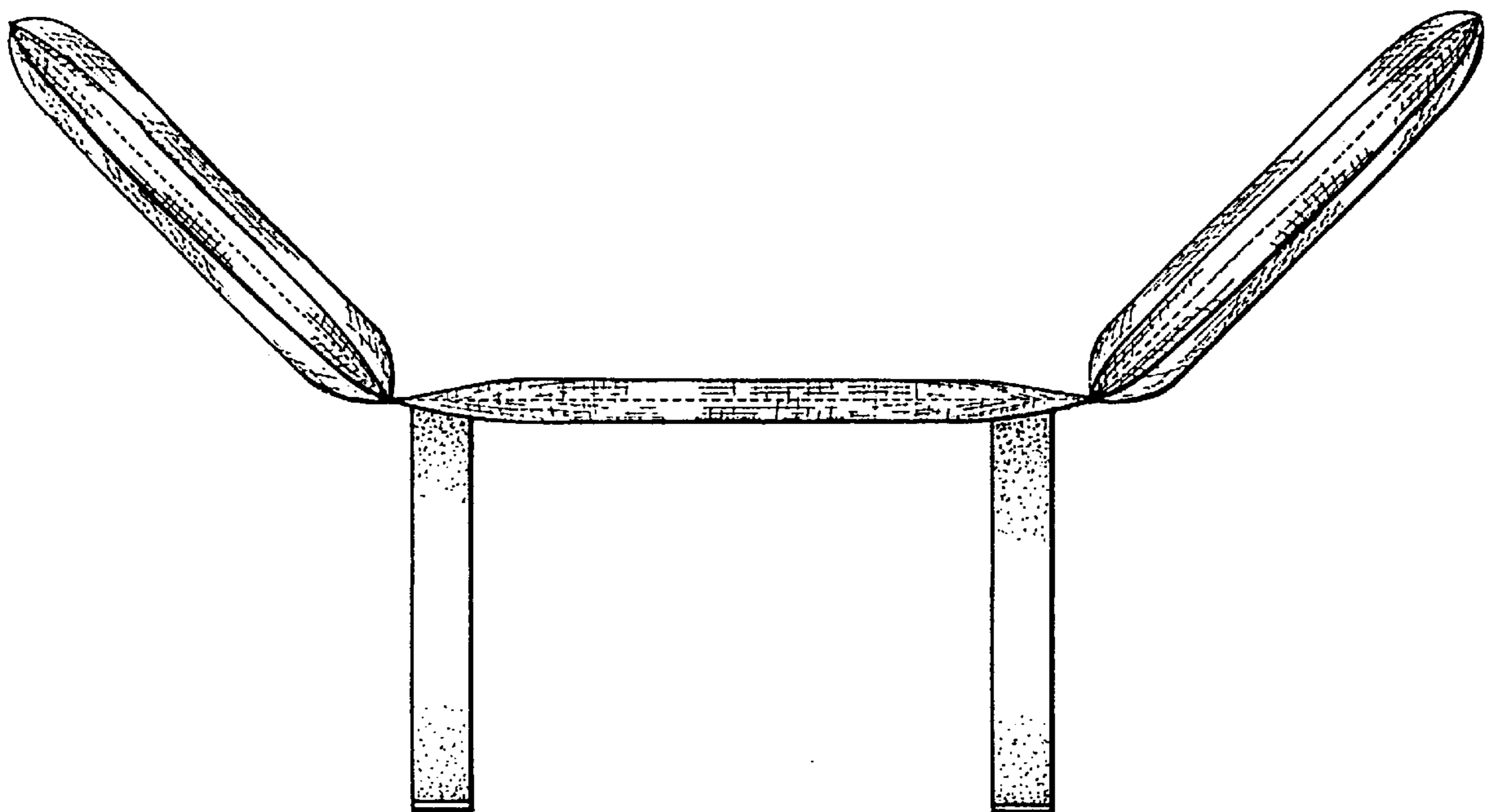
*Fig. 2*



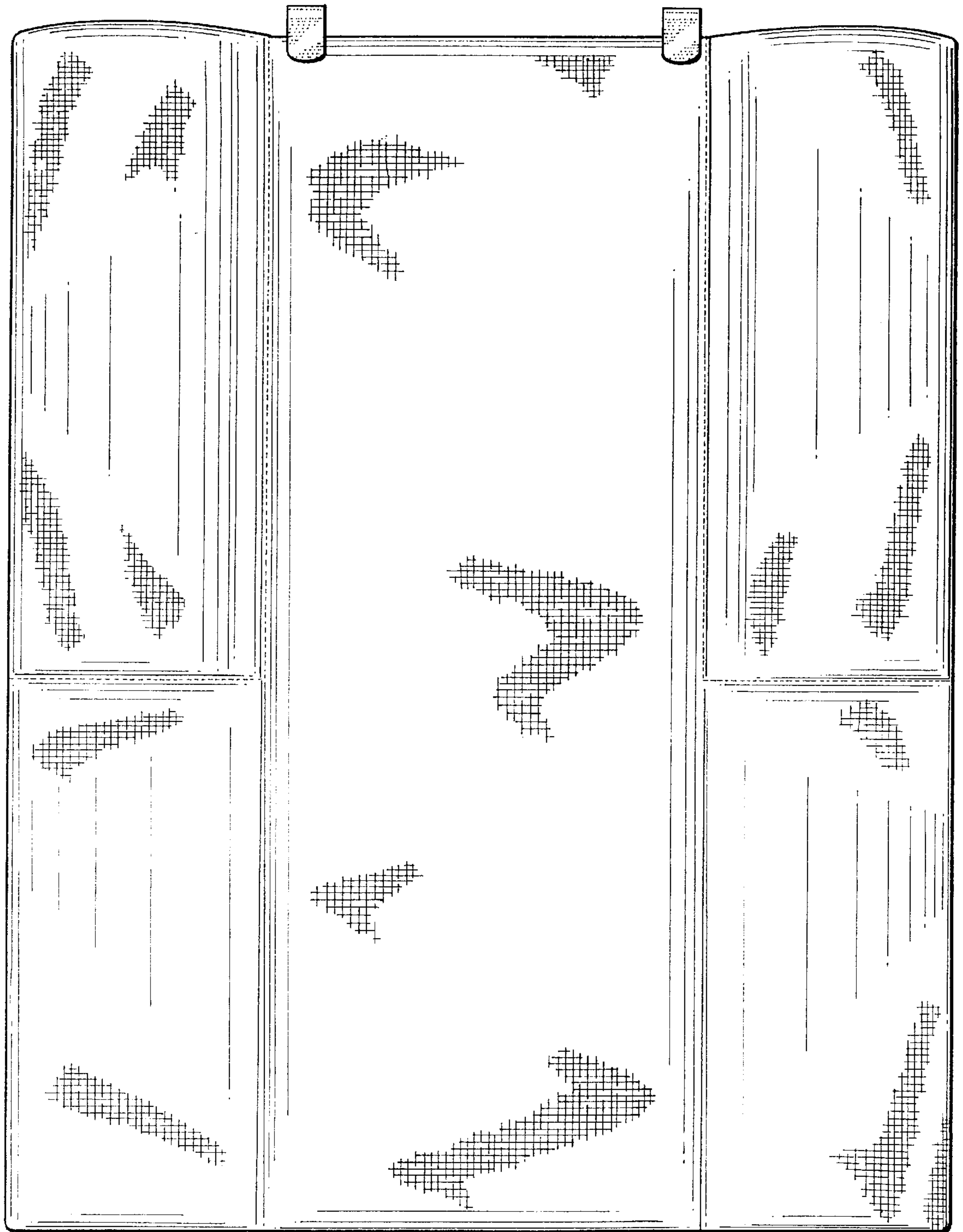
*Fig. 3*



*Fig. 4*



*Fig. 5*



*Fig. 6*