



US00D398800S

United States Patent [19]

Phillips et al.

[11] Patent Number: **Des. 398,800**

[45] Date of Patent: ****Sep. 29, 1998**

[54] **1.5 GALLON SOAP DISPENSER**

D. 285,397 9/1986 Breger D6/545

[75] Inventors: **Brian Phillips**, Joliet; **Eric Wilmot**, Chicago; **John Kauzlarich**, Clarendon Hills, all of Ill.

Primary Examiner—Brian N. Vinson
Attorney, Agent, or Firm—Emrich & Dithmar

[73] Assignee: **Steiner Company, Inc.**, Chicago, Ill.

[57] **CLAIM**

[**] Term: **14 Years**

The ornamental design for the 1.5 gallon soap dispenser, as shown and described.

[21] Appl. No.: **76,665**

DESCRIPTION

[22] Filed: **Sep. 12, 1997**

FIG. 1 is a perspective view of the soap dispenser illustrating the new design;

[51] **LOC (6) Cl.** **07-07**

FIG. 2 is a front elevational view of the soap dispenser illustrated in FIG. 1;

[52] **U.S. Cl.** **D6/545**

FIG. 3 is a rear elevational view of the soap dispenser illustrated in FIG. 1;

[58] **Field of Search** D6/542-545; 222/156, 222/159, 173, 180, 181; 221/282

FIG. 4 is a top elevational view of the dispenser illustrated in FIG. 1;

[56] **References Cited**

FIG. 5 is a bottom elevational view of the dispenser illustrated in FIG. 1; and,

U.S. PATENT DOCUMENTS

FIG. 6 is a side elevational view of the dispenser illustrated in FIG. 1.

- D. 189,521 1/1961 Phillipe D6/545
- D. 199,663 12/1964 Kuehner D6/545
- D. 271,165 11/1983 Lander D6/545

1 Claim, 6 Drawing Sheets

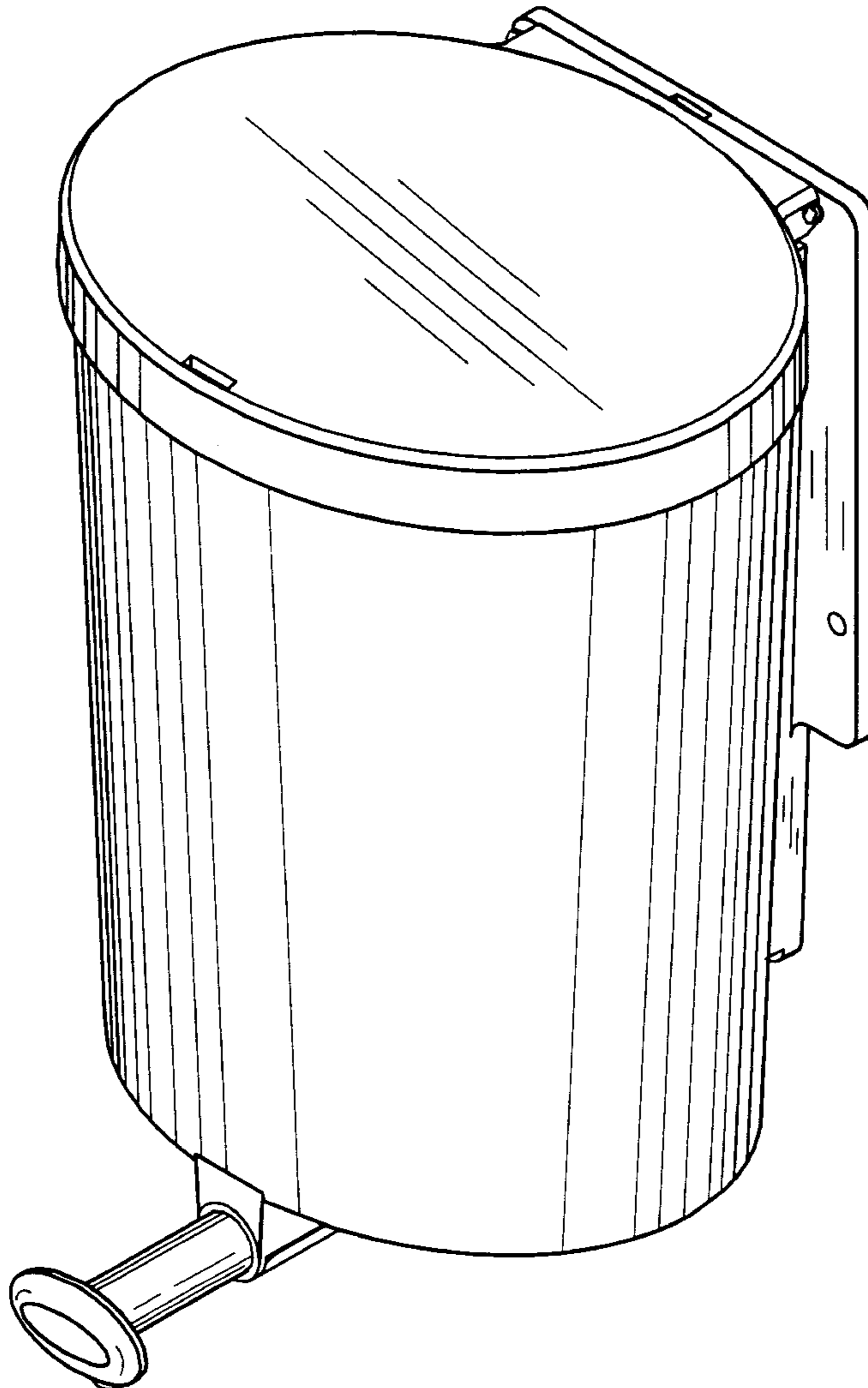

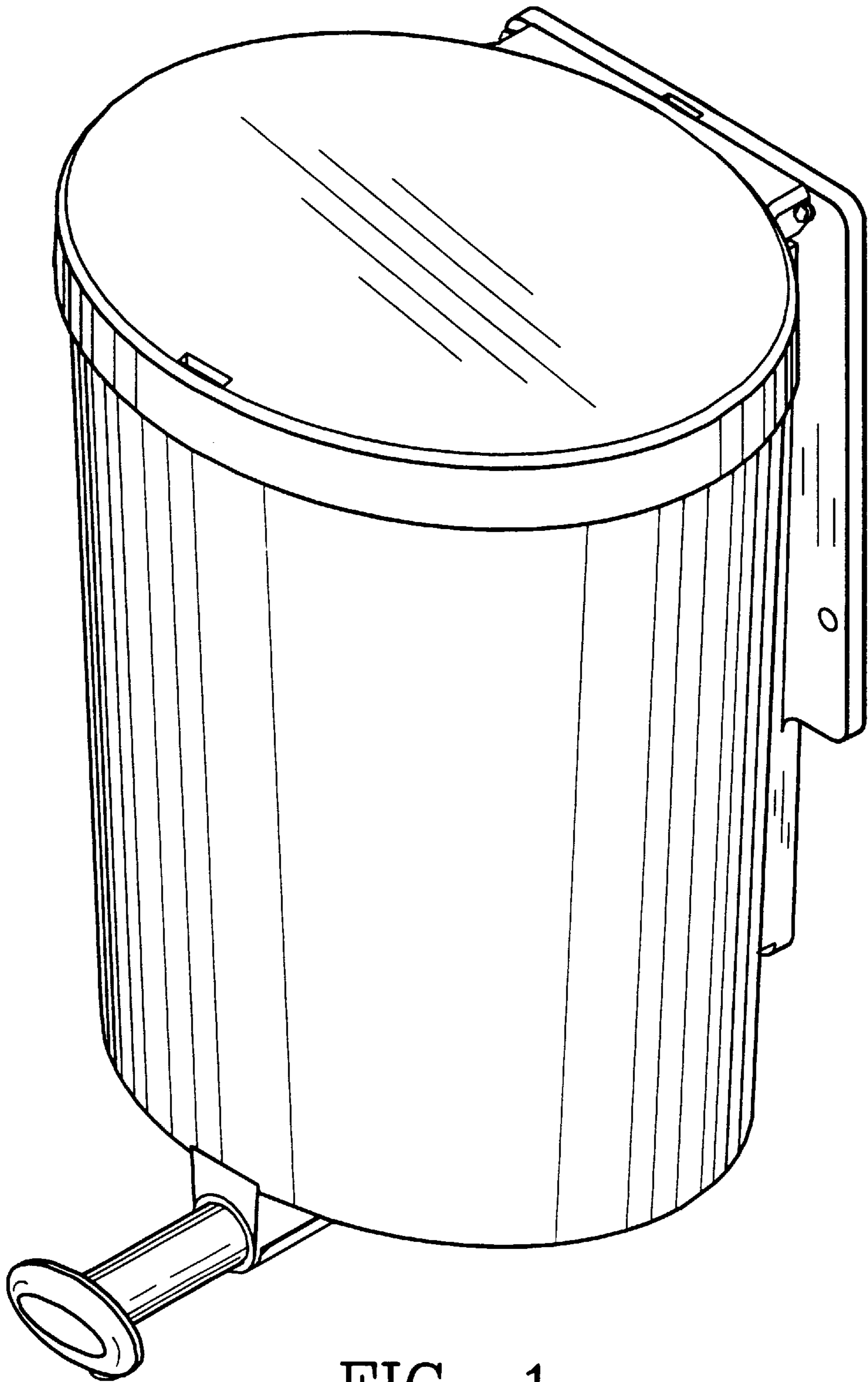

FIG. 1

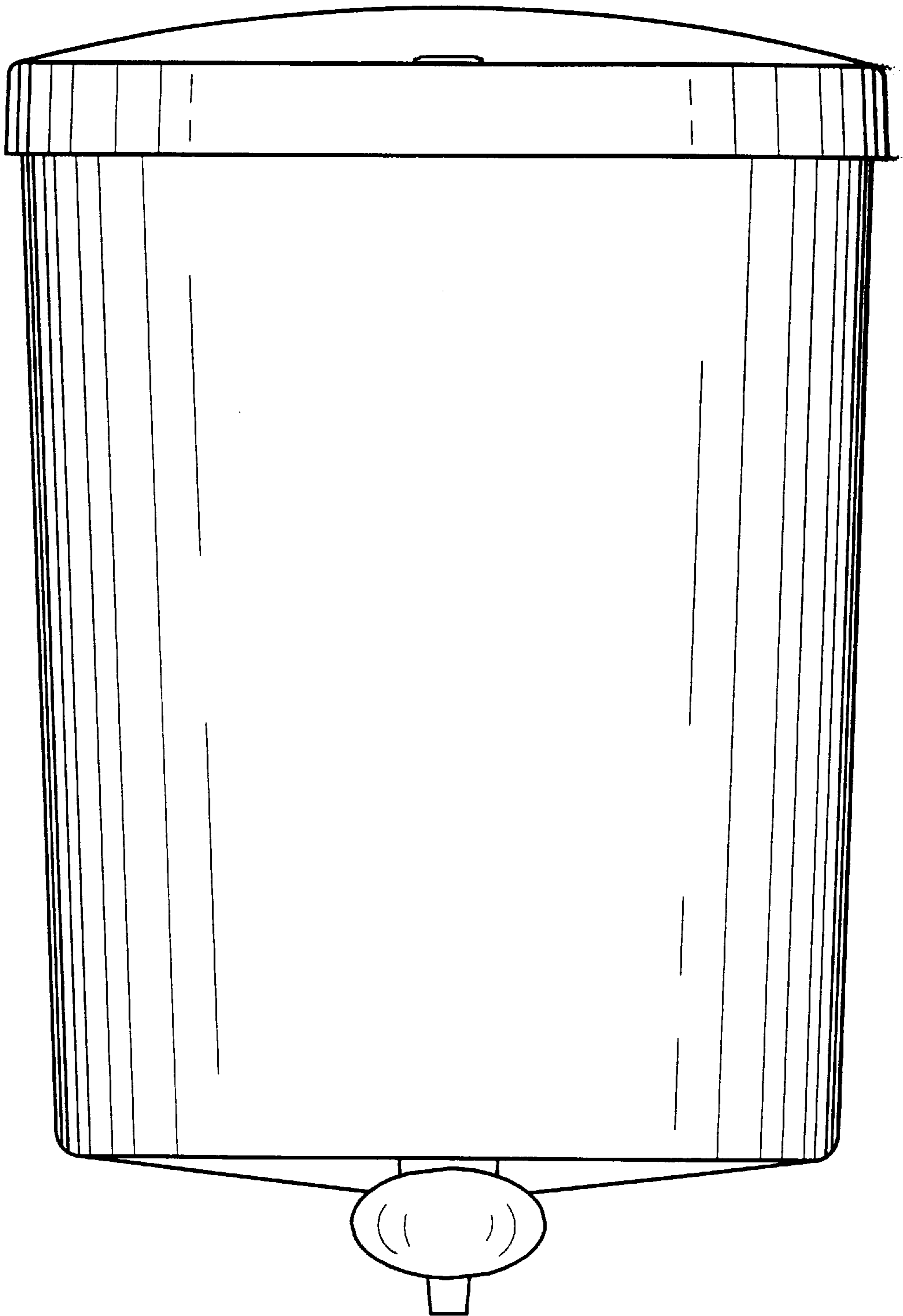

FIG. 2

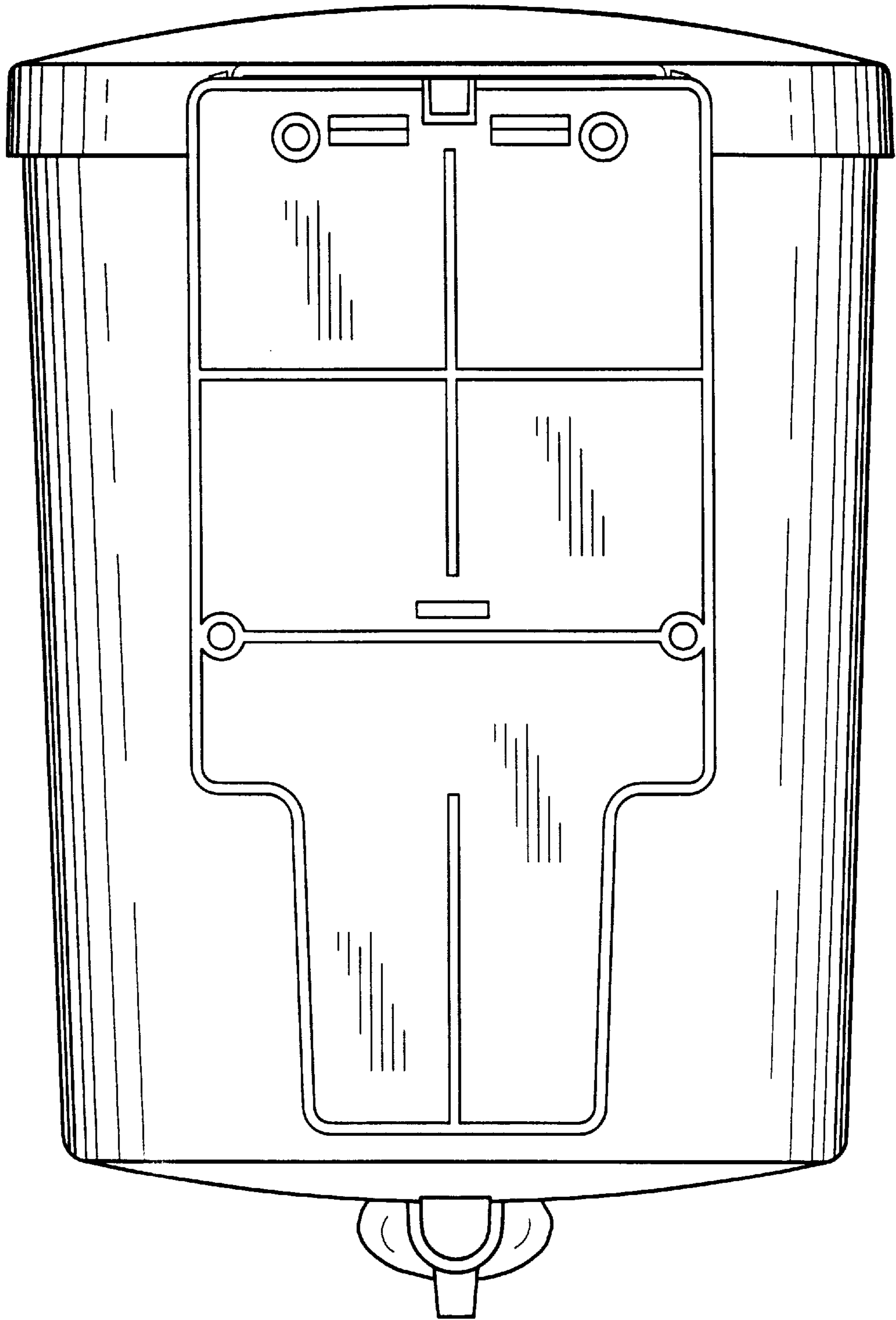

FIG. 3

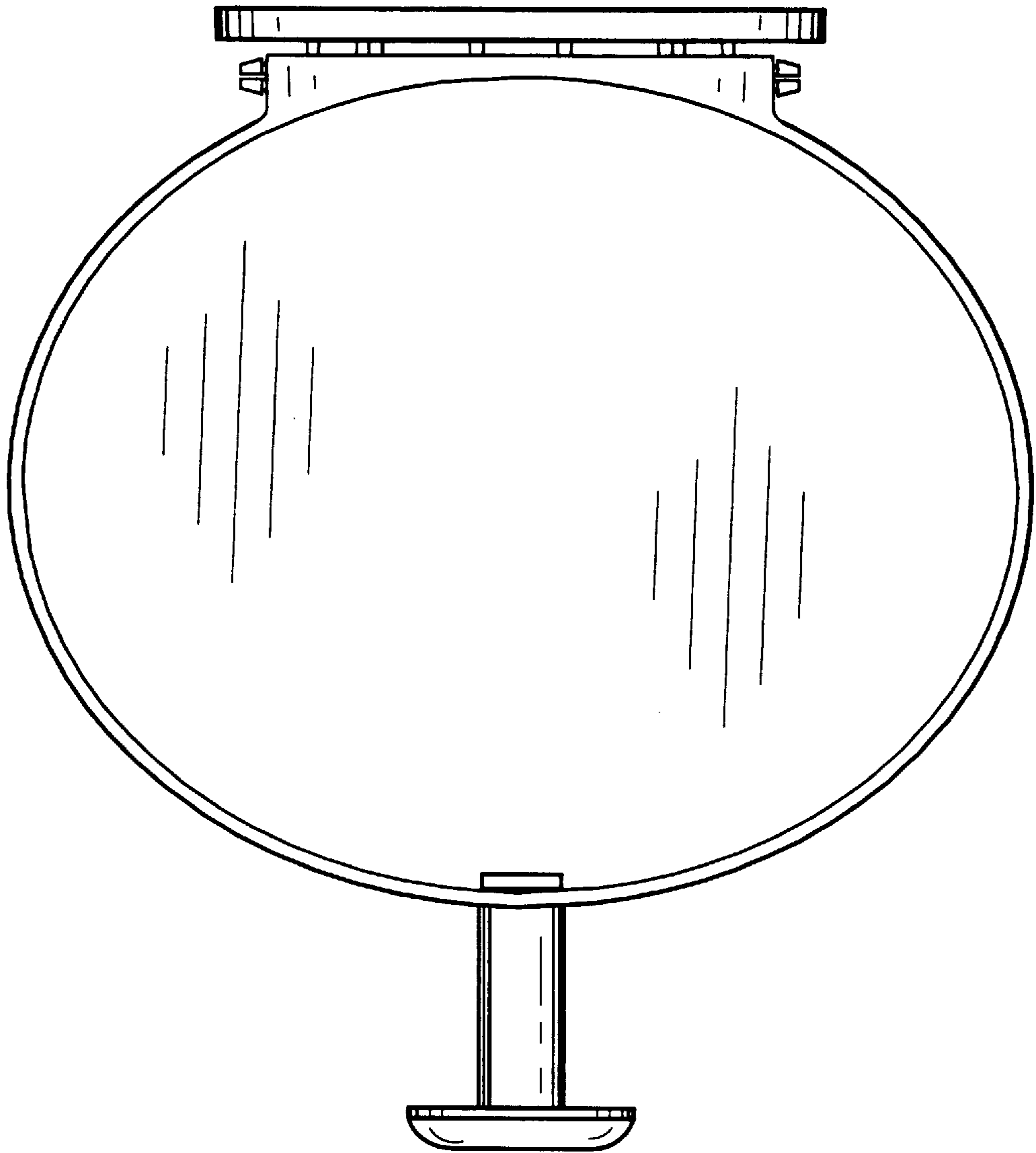

FIG. 4

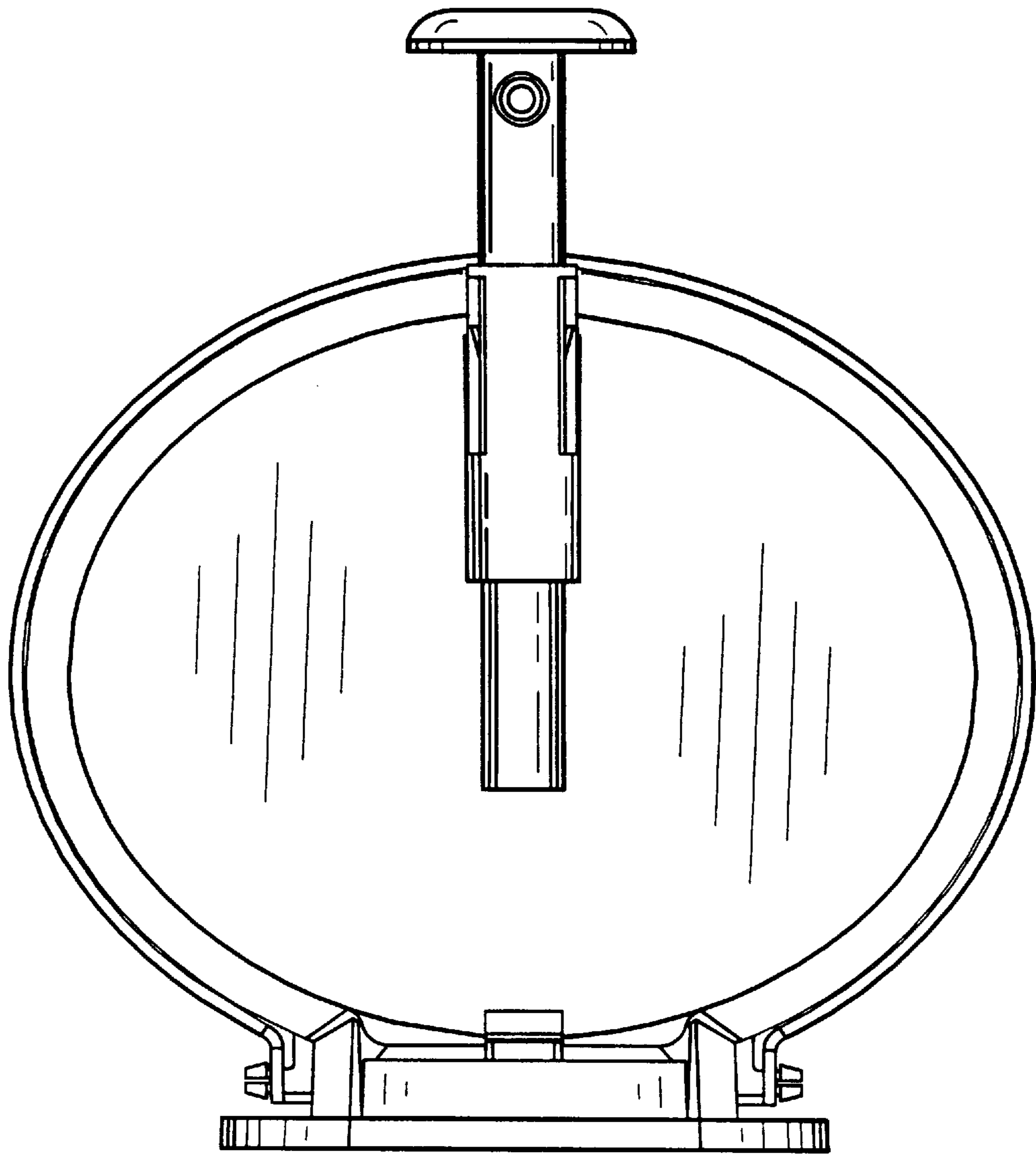

FIG. 5

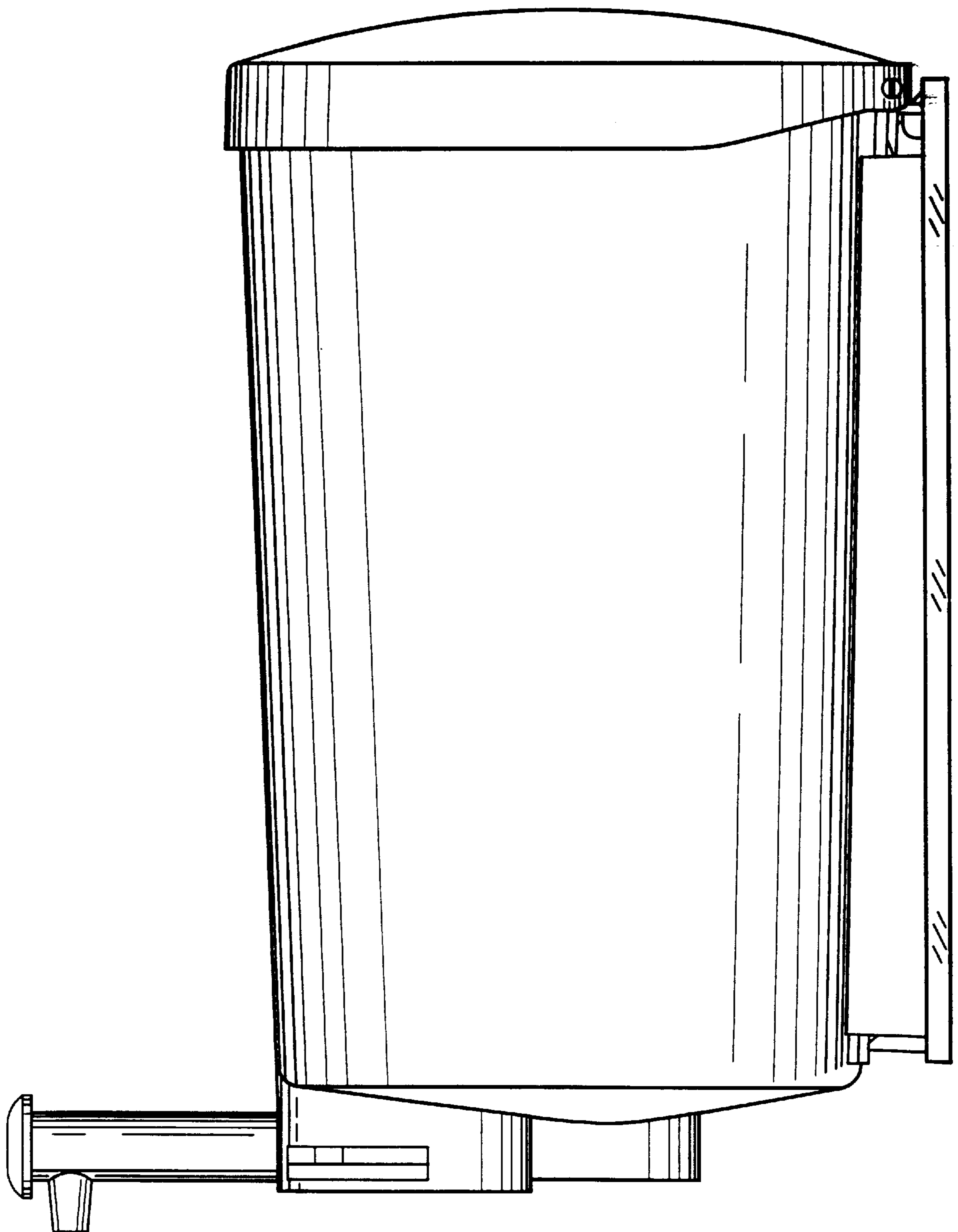

FIG. 6