



US00D398726S

United States Patent [19]

Presnell et al.

[11] Patent Number: **Des. 398,726**

[45] Date of Patent: ****Sep. 22, 1998**

[54] **WASTE CONTAINER TROLLEY**

[75] Inventors: **Donald C. Presnell**, Stephens City, Va.;
Brett Severance, Ann Arbor, Mich.;
Robert J. Tokash, Stephens City, Va.;
Joel Wittkamp, Raleigh, N.C.

4,905,945 3/1990 Peterson 248/907
4,930,653 6/1990 Machando 220/23
5,005,729 4/1991 Hollman 220/908
5,040,808 8/1991 McIntyre 248/907
5,052,703 10/1991 Bertrand 220/47.34
5,074,572 12/1991 Delmerico et al. 280/47.34
5,110,147 5/1992 Gershman 280/79.5

[73] Assignee: **Rubbermaid Commercial Products Inc.**, Winchester, Va.

[**] Term: **14 Years**

[21] Appl. No.: **49,894**

[22] Filed: **Feb. 2, 1996**

[51] **LOC (6) Cl.** **09-09**

[52] **U.S. Cl.** **D34/10**

[58] **Field of Search** D34/1, 5-7, 9,
D34/10, 11; 220/908-9; 248/95, 97, 99,
907, 346

[56] **References Cited**

U.S. PATENT DOCUMENTS

D. 214,644	7/1969	Maris	D34/1
D. 251,833	5/1979	Maza et al.	D12/31
D. 256,902	9/1980	Maza et al.	D12/31
D. 257,721	12/1980	Maza et al.	D12/31
D. 257,767	1/1981	Maza et al.	D12/31
D. 257,823	1/1981	Maza et al.	D12/31
D. 299,578	1/1989	Wilson	D34/5
D. 321,965	11/1991	Delmerico et al.	D34/23
D. 327,557	6/1992	Juergens	D34/11
D. 327,756	7/1992	Klein et al.	D34/1
D. 340,761	10/1993	Long	D34/10
926,288	6/1909	Rice .	
2,545,320	3/1951	Tilson et al.	248/907
3,031,207	4/1962	Bard	280/260
3,208,768	9/1965	Hulbert	280/408
3,366,396	1/1968	Hardy	280/32.5
3,689,106	9/1972	Young	280/179 R
3,802,717	4/1974	Eitreim	280/79.1
3,904,218	9/1975	Kostle	280/79.2
4,103,919	8/1978	Greenheck	280/79.1
4,127,202	11/1978	Jennings et al.	214/85
4,203,609	5/1980	Mitchell et al.	280/47.11
4,222,580	9/1980	Krokonko	280/47.34
4,313,612	2/1982	Rubens	208/79.1

FOREIGN PATENT DOCUMENTS

506025 9/1954 Canada .
154659 3/1954 Sweden .

OTHER PUBLICATIONS

Sell sheet, Dolly; Beckson Industrial Products Inc., Box 648, Guilford, Connecticut 06437. Published at least as early as Jan., 1996.

Sell sheet, Trolley; Hammerlit GmbH, 26762 Lee, Postfach. Published at least as early as Oct., 1995.

Sell sheet, Trolley; Schlosser & Co., GmbH, Industriestr. 39, 8062 Markt Indersdorf. Published at least as early as Oct., 1995.

Pp. 8 and 9, Dollies; Continental Manufacturing Company, 123 Byassee Drive, Hazelwood, Missouri 63042. Published at least as early as Oct., 1994.

Catalog page, Dolly; Tucker Housewares, 25 Tucker Drive, Leominster, Massachusetts 01453. Published at least as early as May, 1994.

Primary Examiner—Alan P. Douglas
Assistant Examiner—Robin V. Taylor
Attorney, Agent, or Firm—Richard B. O'Planick

[57] **CLAIM**

The ornamental design for a waste container trolley, as shown and described.

DESCRIPTION

FIG. 1 is a top left front perspective view of a waste container trolley showing our new design;
FIG. 2 is a top plan view thereof;
FIG. 3 is a left side elevational view thereof;
FIG. 4 is a front elevational view thereof;
FIG. 5 is a rear elevational view thereof; and,
FIG. 6 is a right side elevational view thereof.

1 Claim, 5 Drawing Sheets

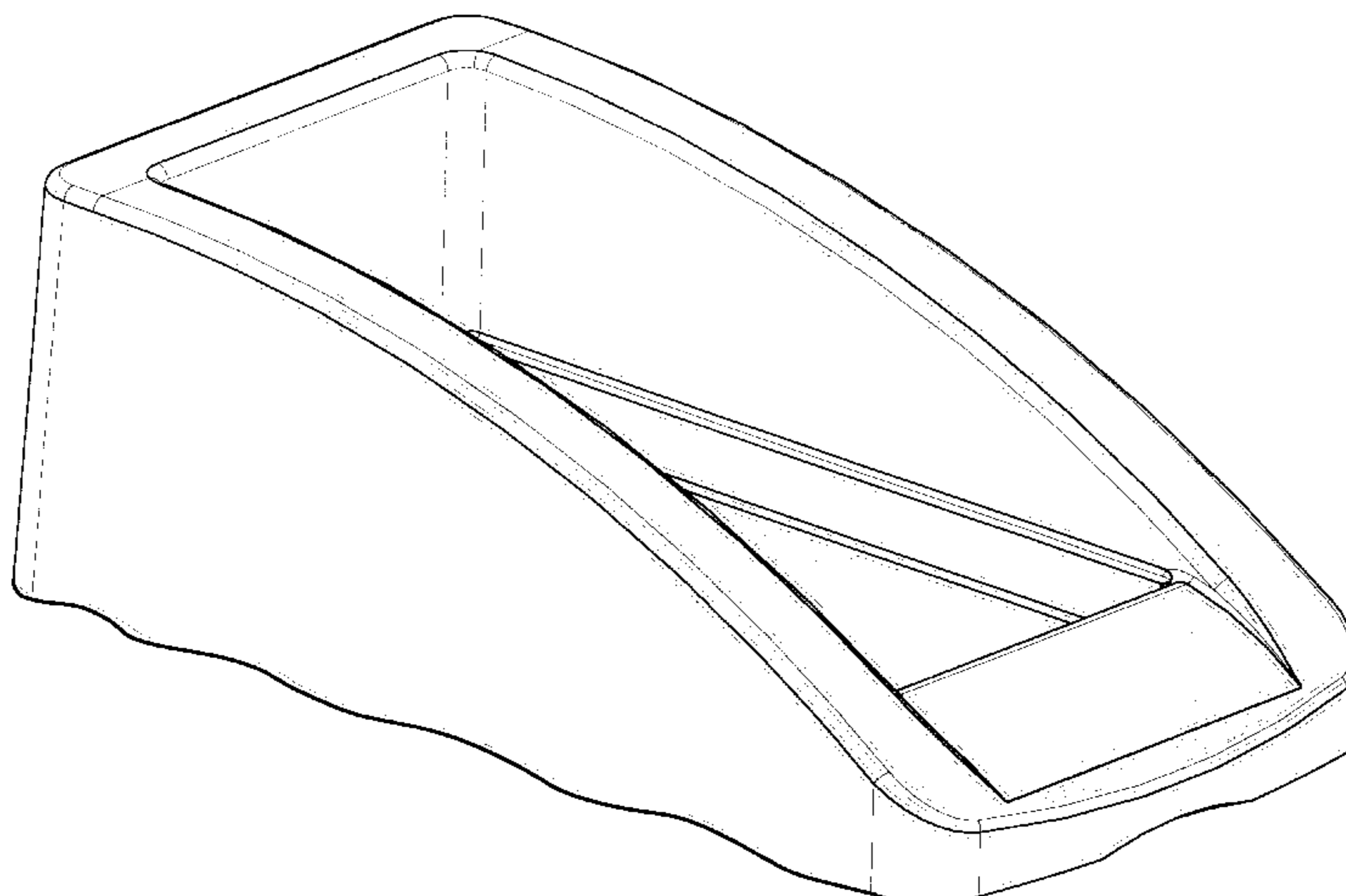

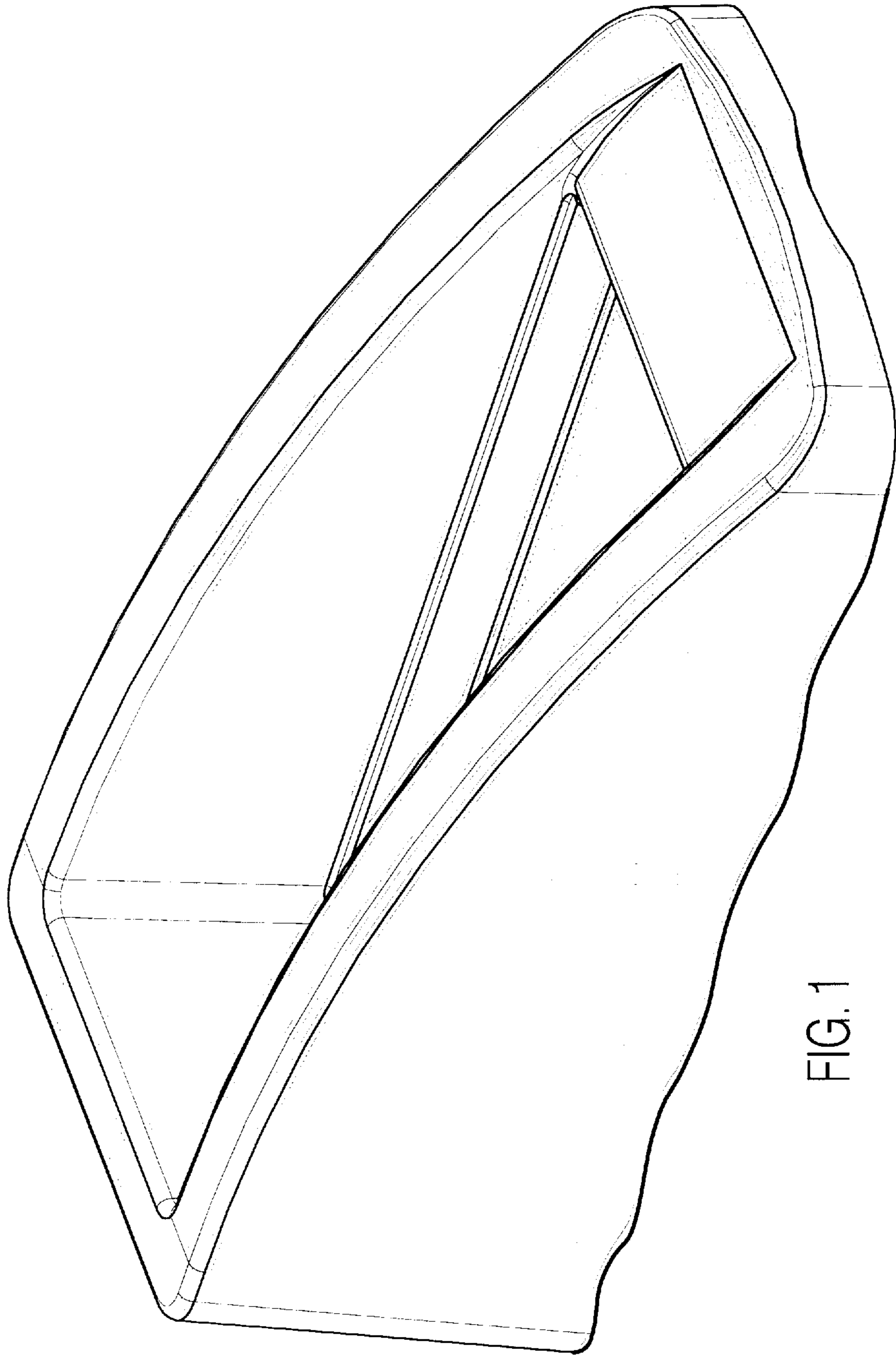

FIG. 1

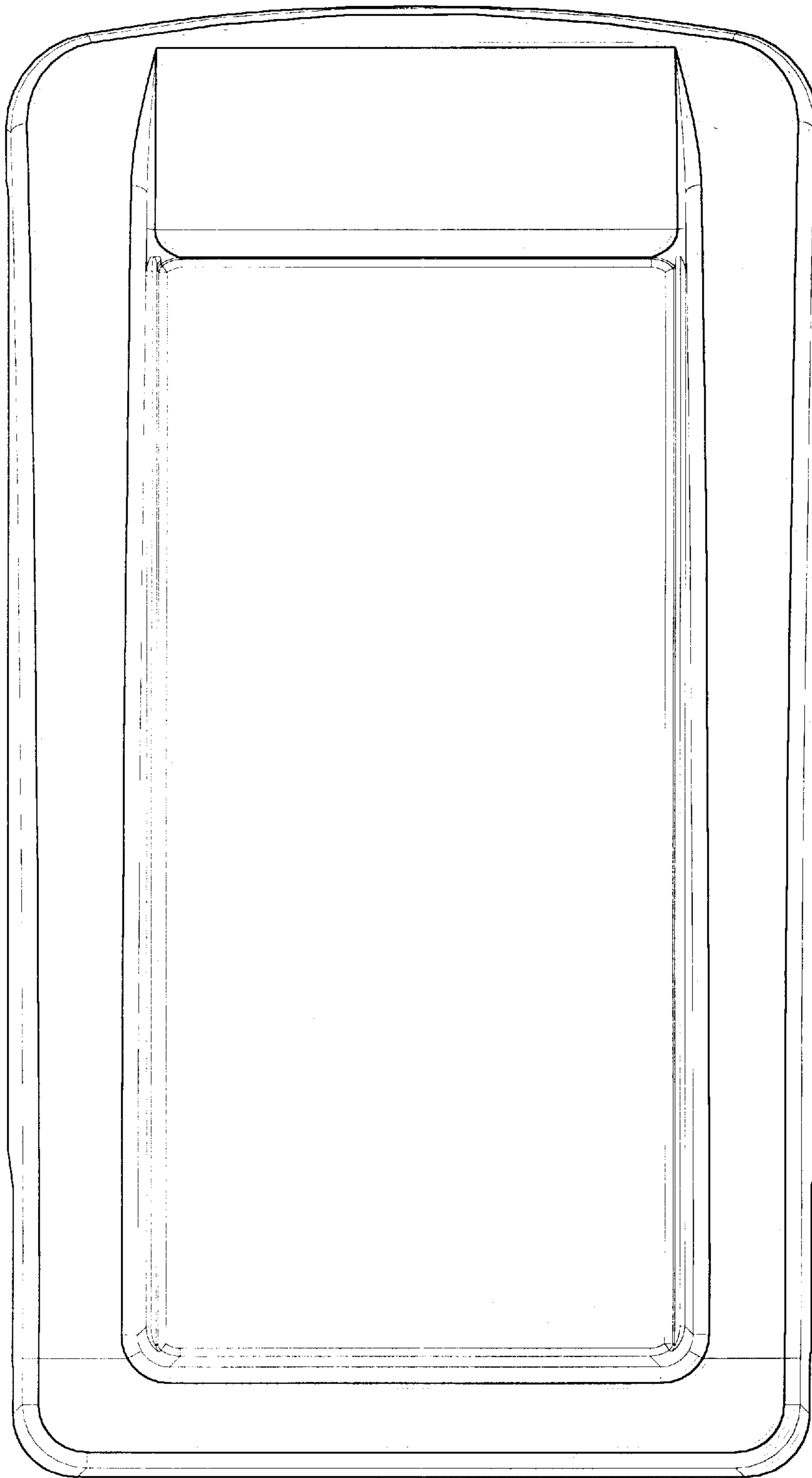

FIG. 2

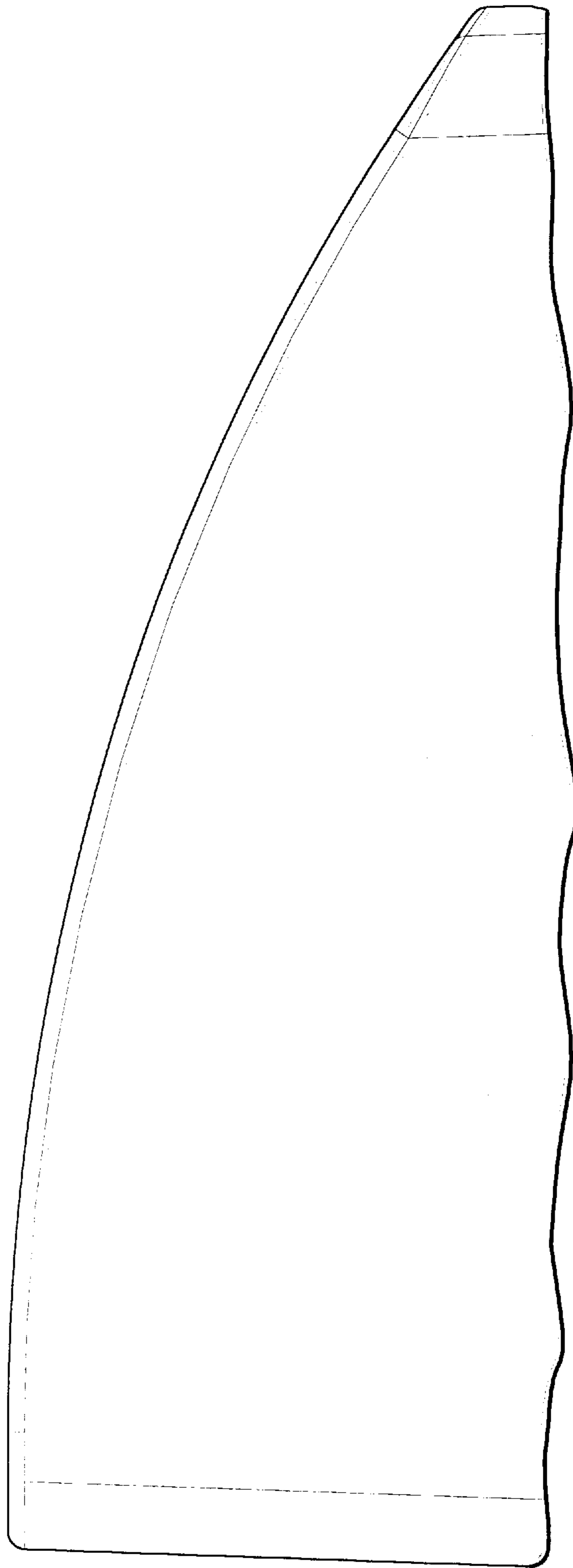

FIG. 3

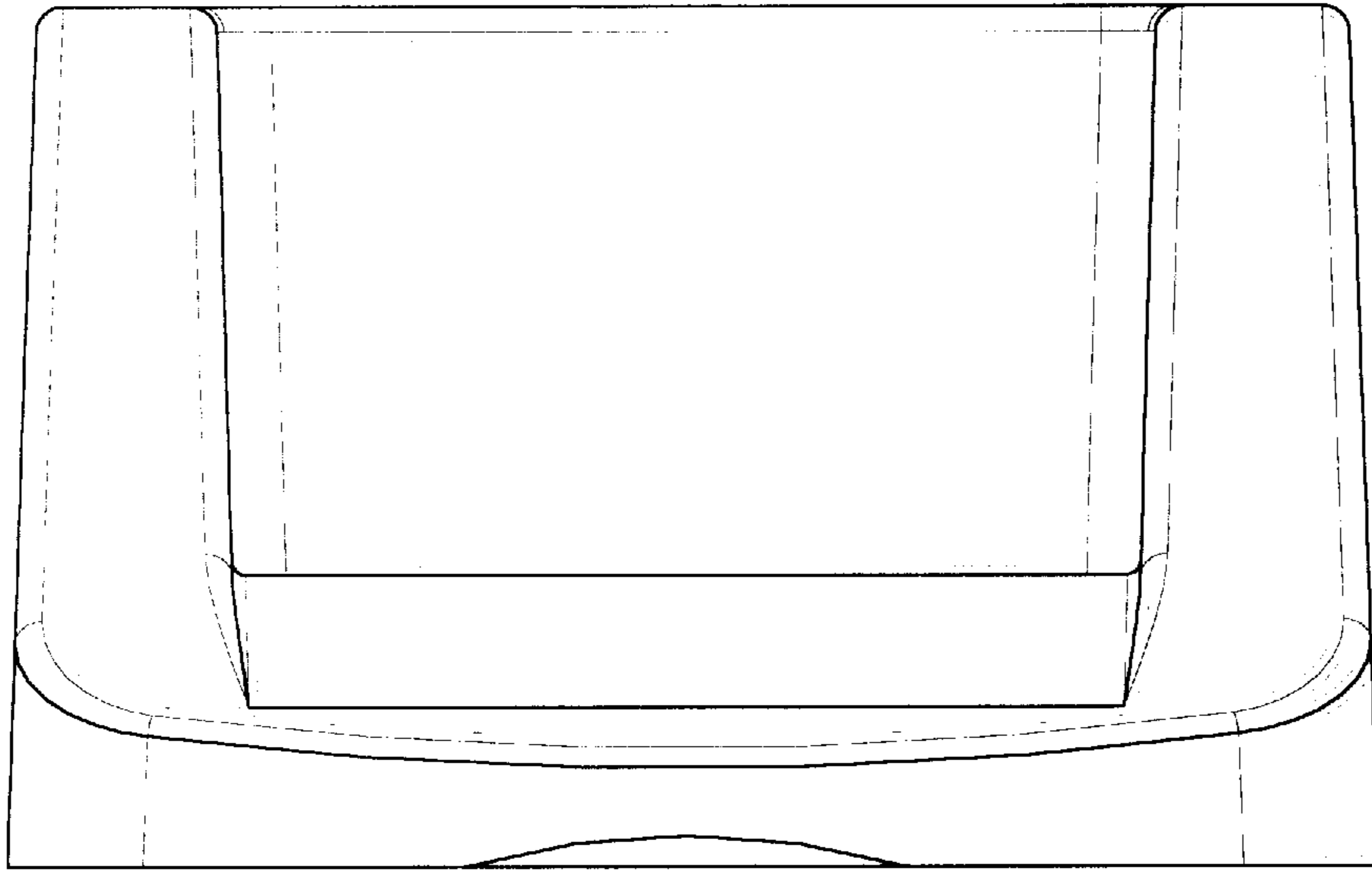

FIG. 4

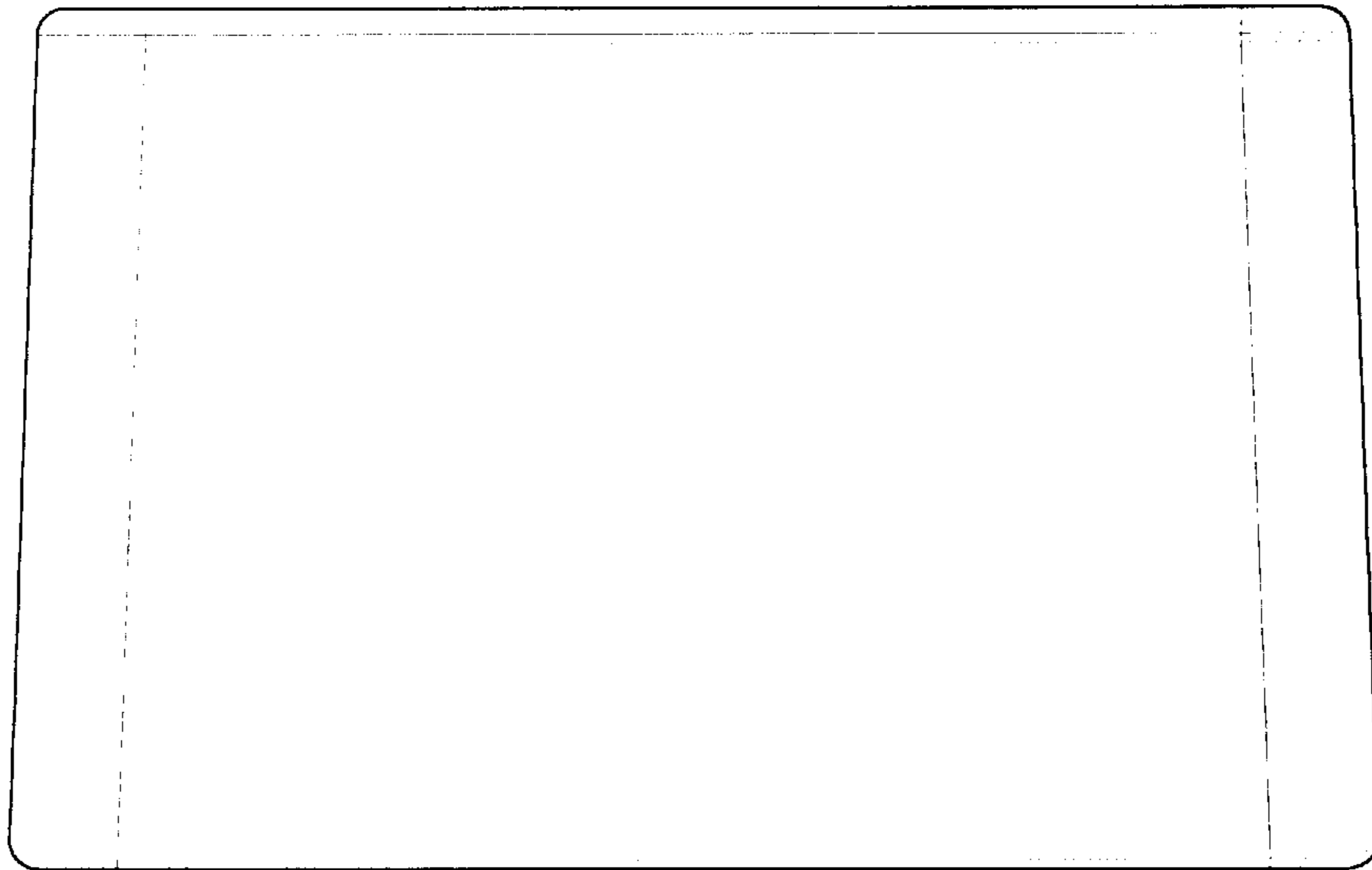

FIG. 5

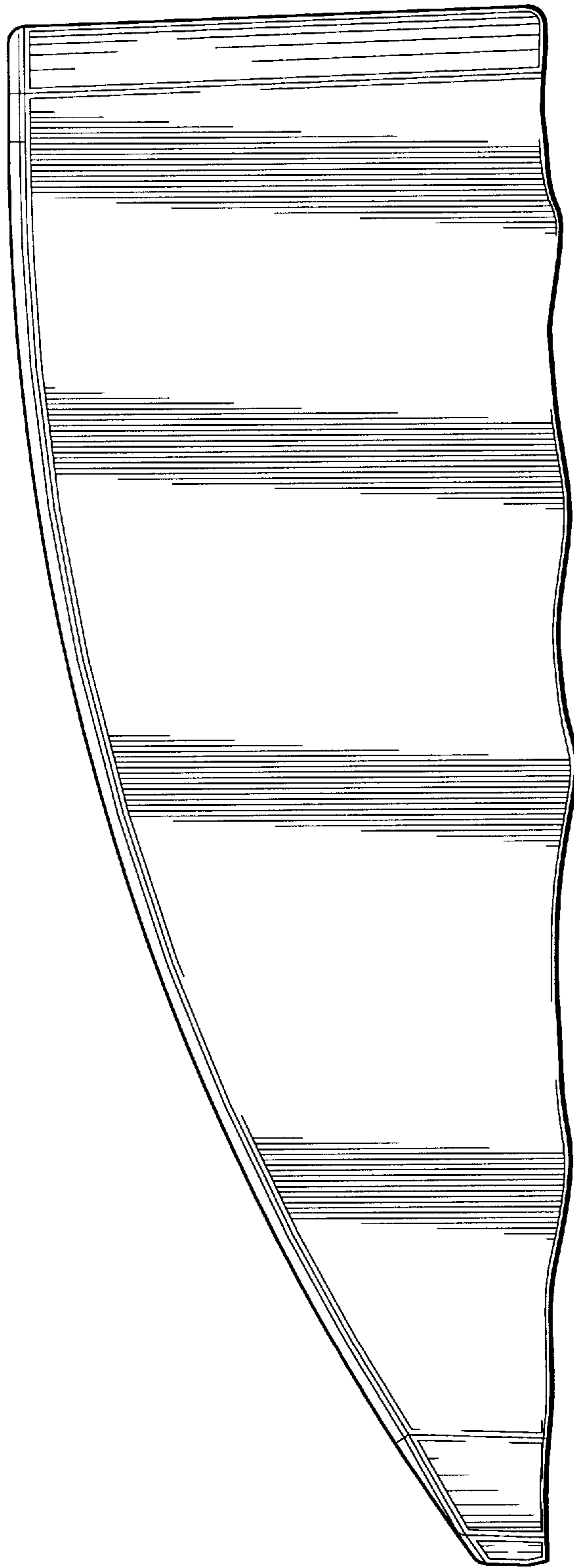

FIG. 6