



US00D398583S

United States Patent [19]

Sette et al.

[11] Patent Number: **Des. 398,583**

[45] Date of Patent: ****Sep. 22, 1998**

[54] **MULTI-CONNECTOR EXPANSION INTERFACE DEVICE**

[75] Inventors: **Paul R. Sette**, Branford; **Richard A. Sloan, Jr.**, Southbury, both of Conn.

[73] Assignee: **Pitney Bowes Inc.**, Stamford, Conn.

[**] Term: **14 Years**

[21] Appl. No.: **61,948**

[22] Filed: **Nov. 4, 1996**

[51] **LOC (6) Cl.** **13-03**

[52] **U.S. Cl.** **D13/147**

[58] **Field of Search** D13/133, 146, D13/147, 162, 164; 439/540.1, 638, 639, 650, 660; 361/683, 686

[56] **References Cited**

U.S. PATENT DOCUMENTS

5,321,580	6/1994	Hosoi et al.	361/683	X
5,325,491	6/1994	Fasig	395/325	
5,386,567	1/1995	Lien et al.	395/700	
5,411,416	5/1995	Balon et al.	439/639	
5,592,362	1/1997	Ohgami et al.	361/686	

OTHER PUBLICATIONS

Western Telematic, Inc., Mar. 1988 Product Catalog, Data Broadcasting Unit, p. 8.

Primary Examiner—Alan P. Douglas
Assistant Examiner—Lavone D. Tabor
Attorney, Agent, or Firm—Robert H. Whisker; Melvin J. Scolnick

[57] **CLAIM**

The ornamental design for a multi-connector expansion interface device, as shown and described.

DESCRIPTION

FIG. 1 is a top, front and right side perspective view of a multi-connector expansion interface device which incorporates the new design;
FIG. 2 is a top plan view thereof;
FIG. 3 is a front view thereof;
FIG. 4 is a right side view thereof;
FIG. 5 is a left side view thereof; and
FIG. 6 is a rear view thereof;
FIG. 7 is a top, front and right side perspective view of an alternative embodiment of a multi-connector expansion interface device which incorporates the new design;
FIG. 8 is a top plan view thereof;
FIG. 9 is a front view thereof;
FIG. 10 is a right side view thereof;
FIG. 11 is a left side view thereof; and,
FIG. 12 is a rear view thereof.

1 Claim, 6 Drawing Sheets

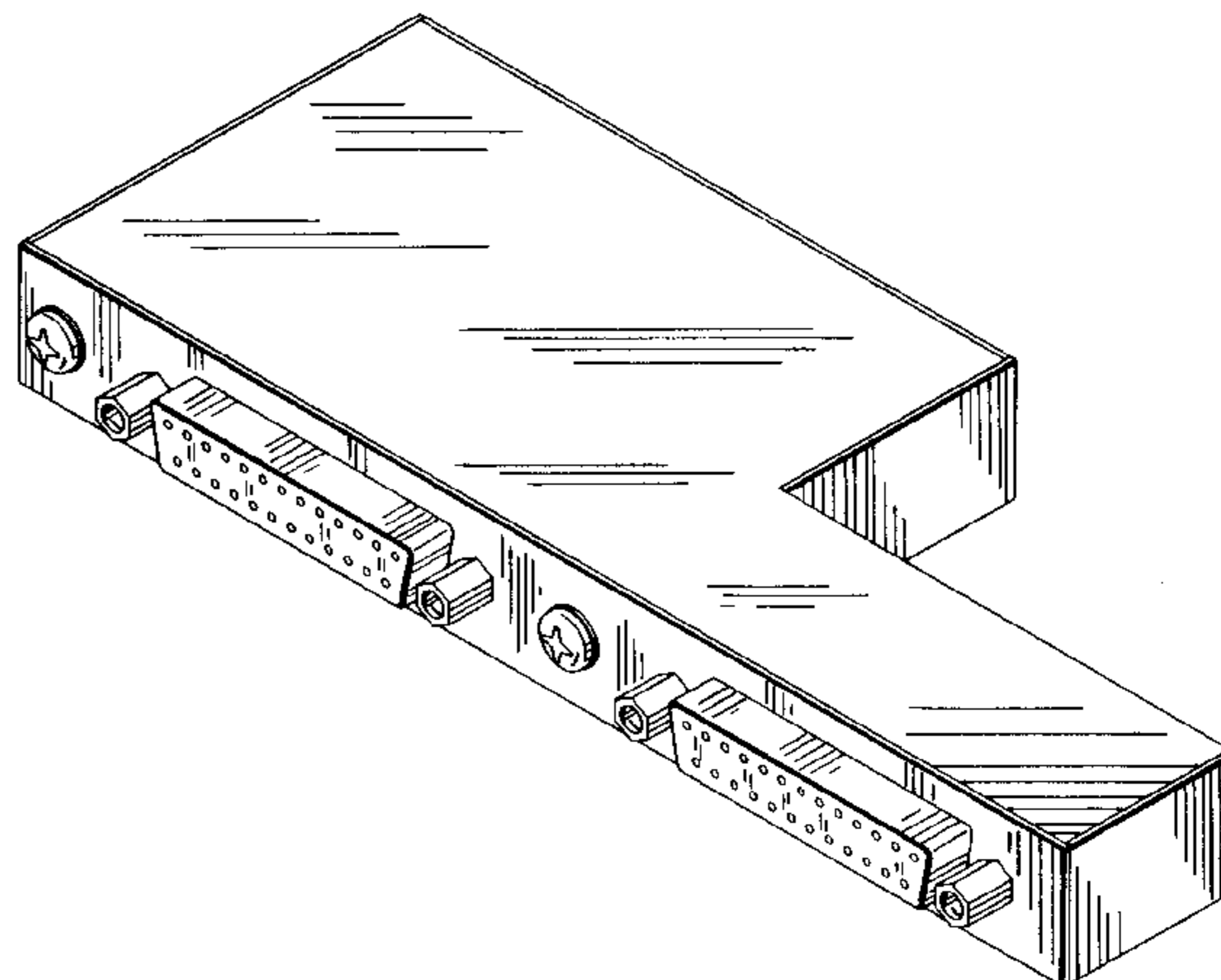
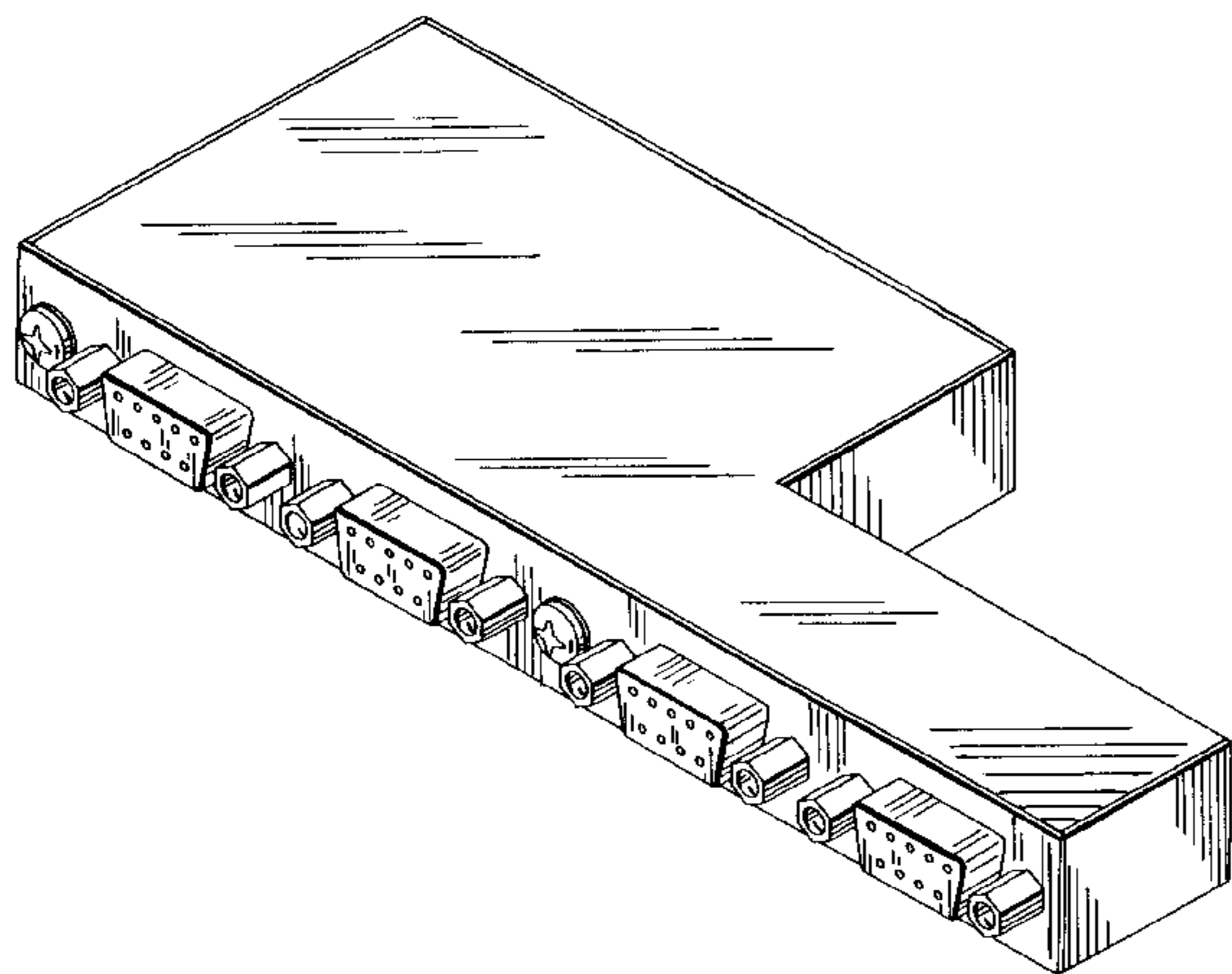

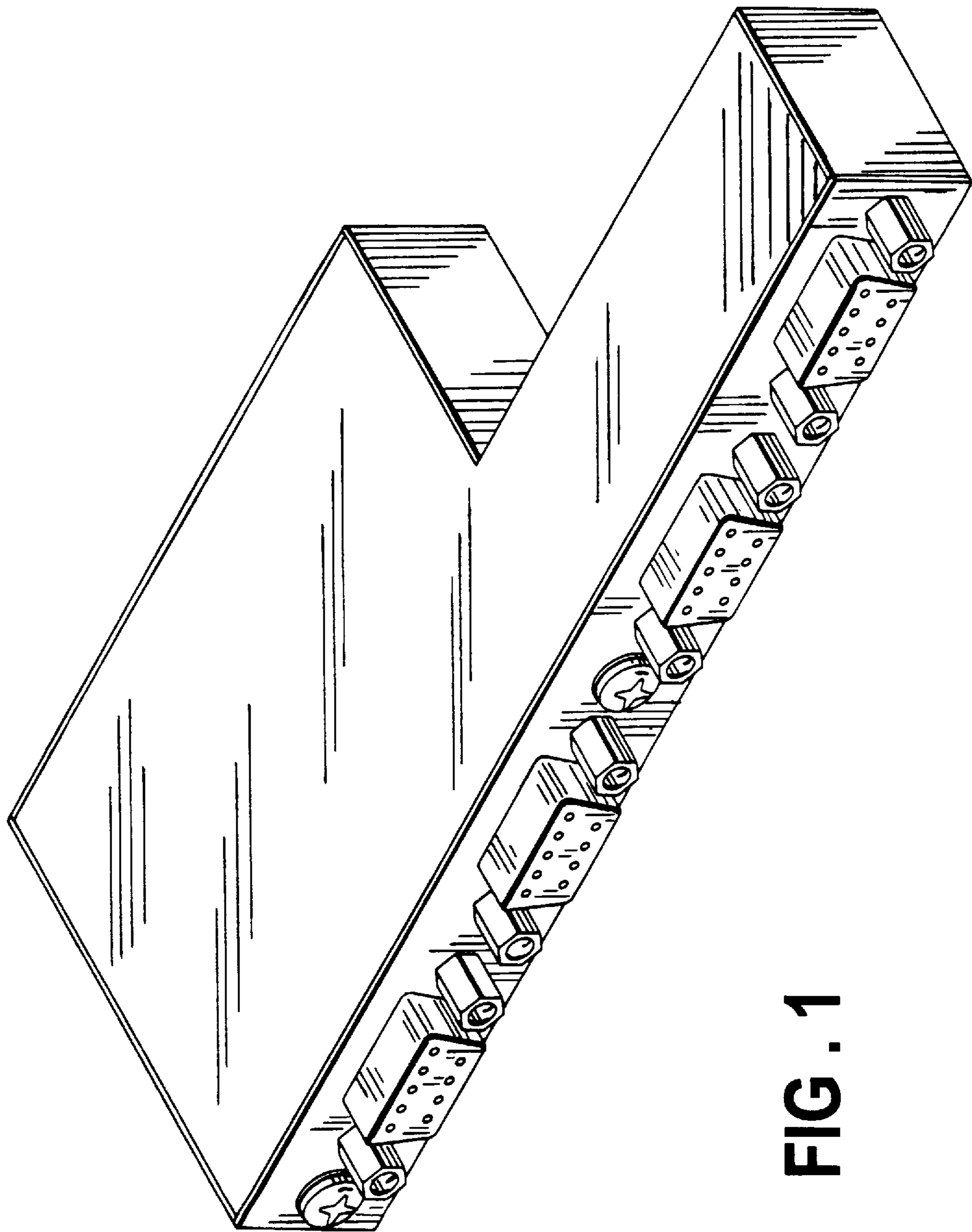

FIG. 1

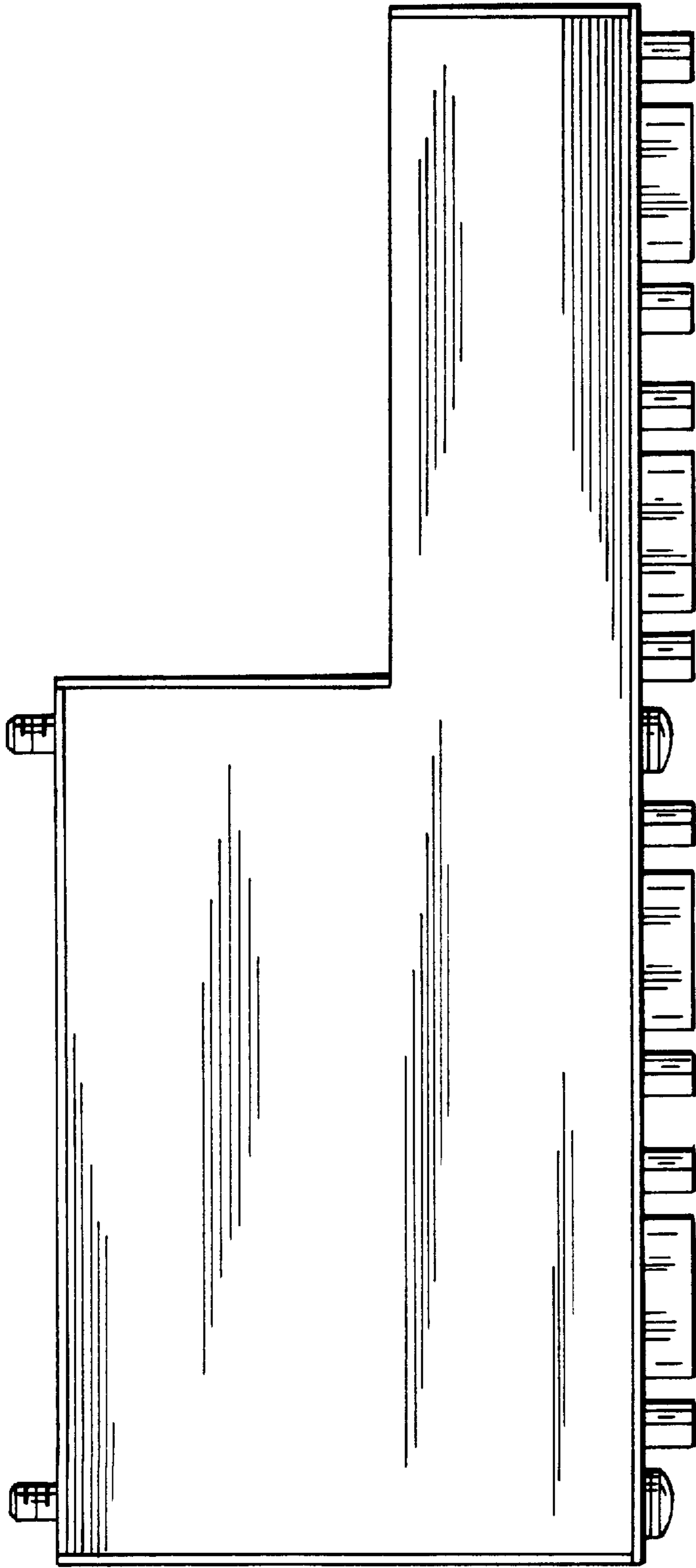

FIG. 2

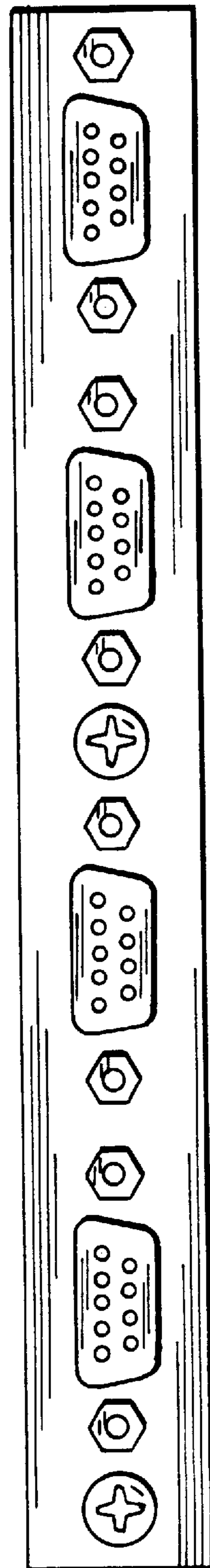

FIG. 3

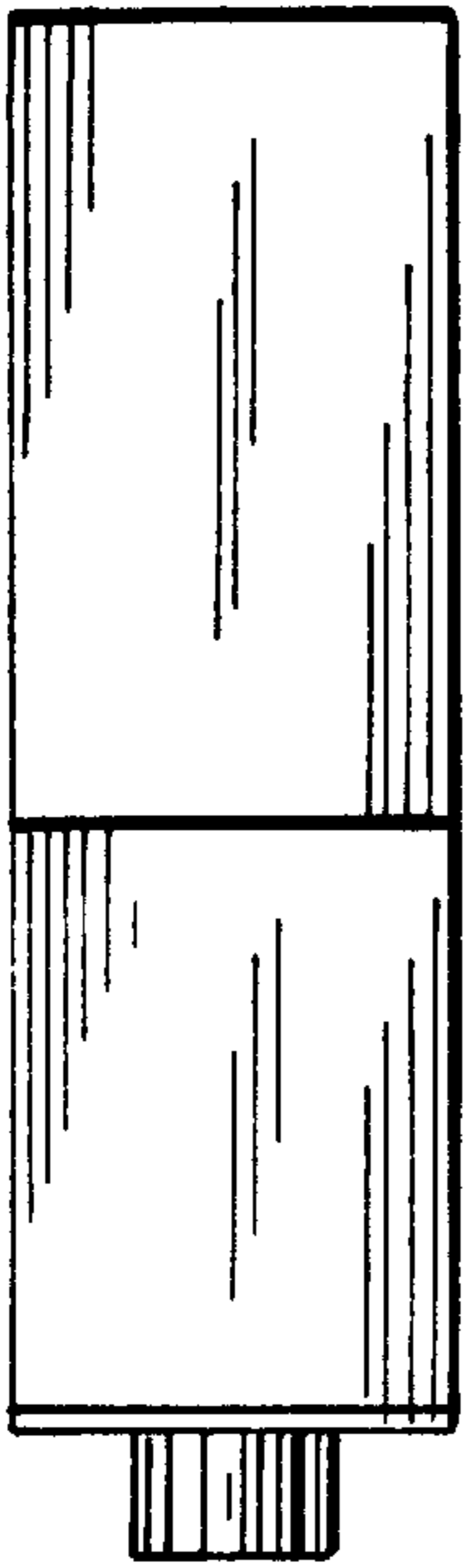

FIG. 4

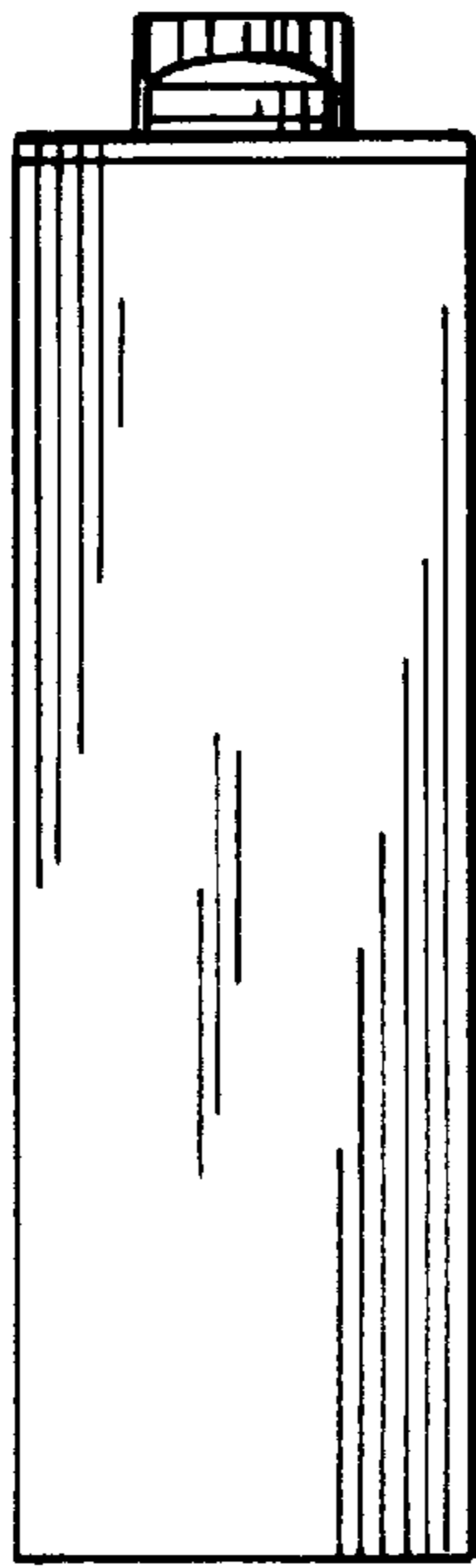

FIG. 5

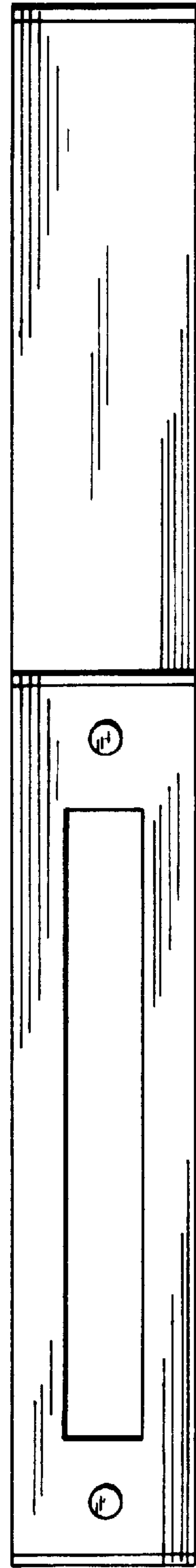

FIG. 6

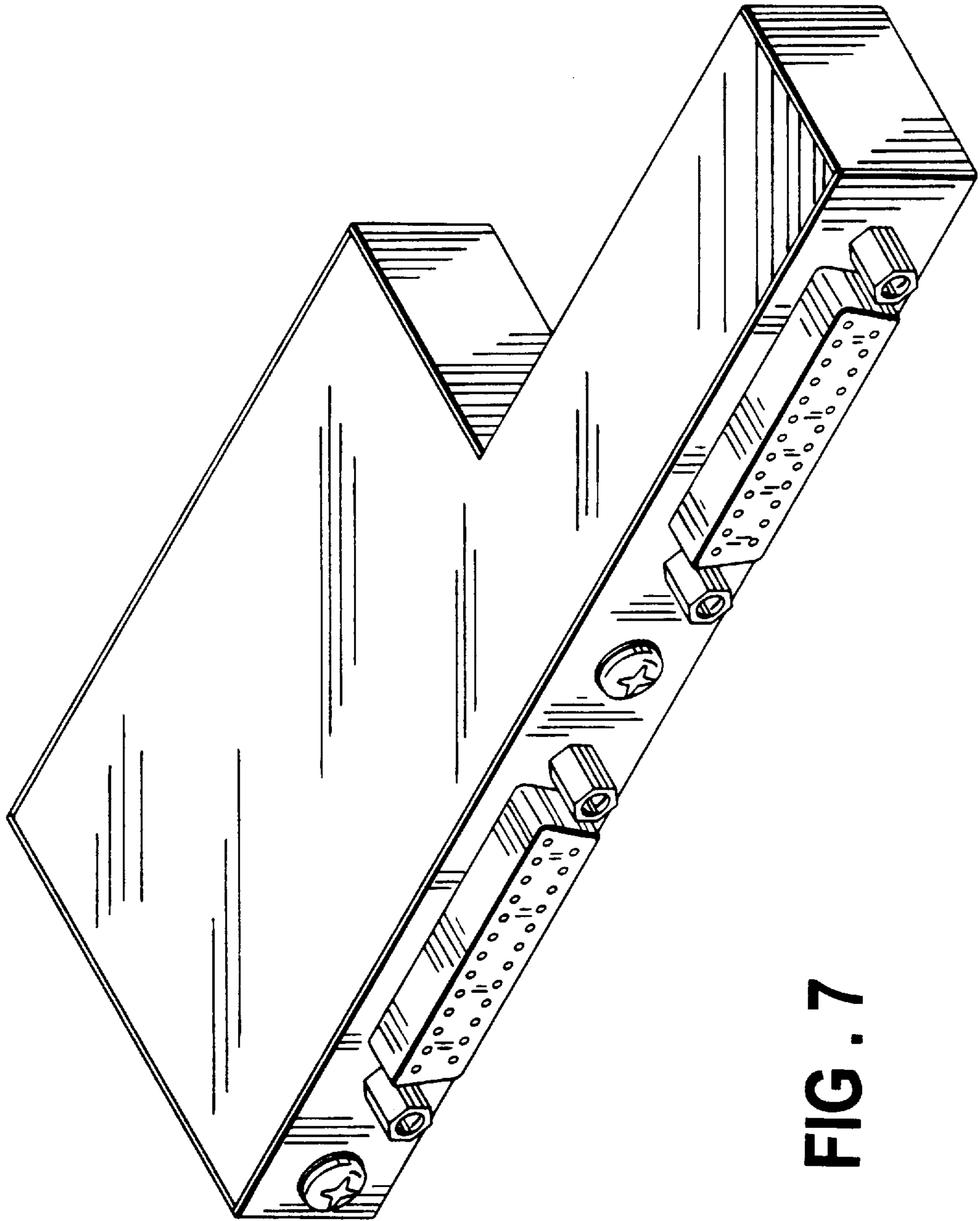

FIG. 7

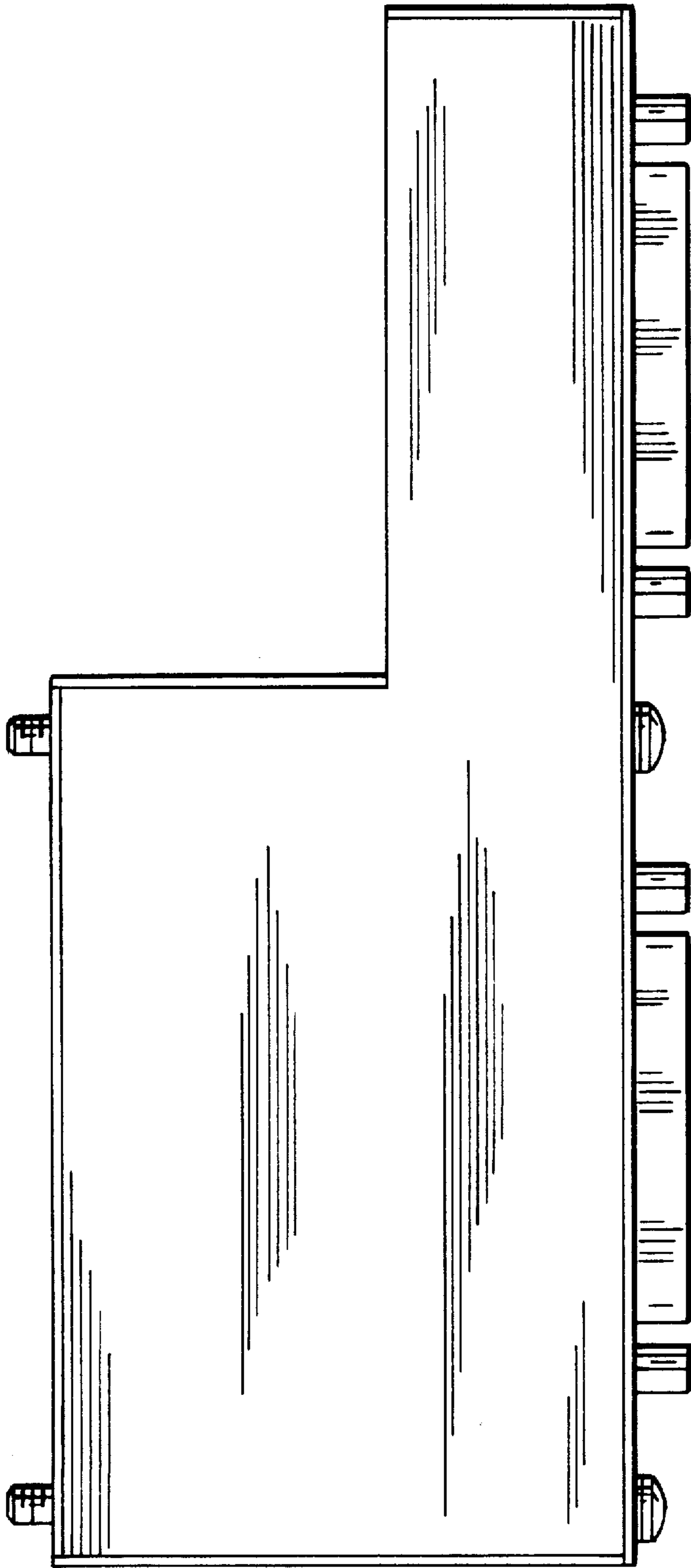

FIG. 8

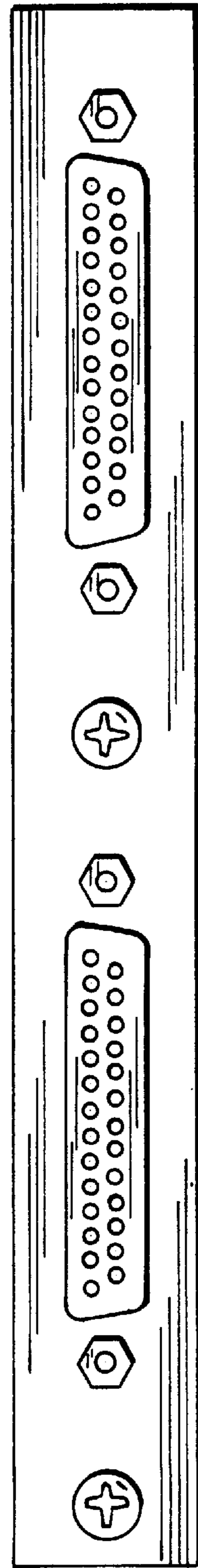

FIG. 9

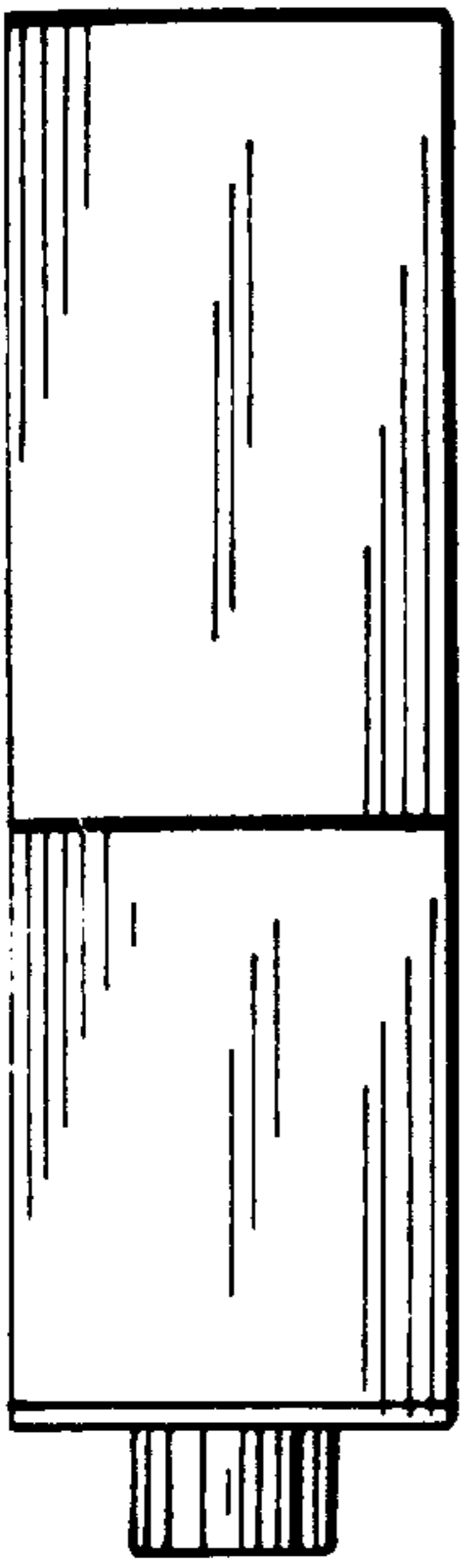

FIG. 10

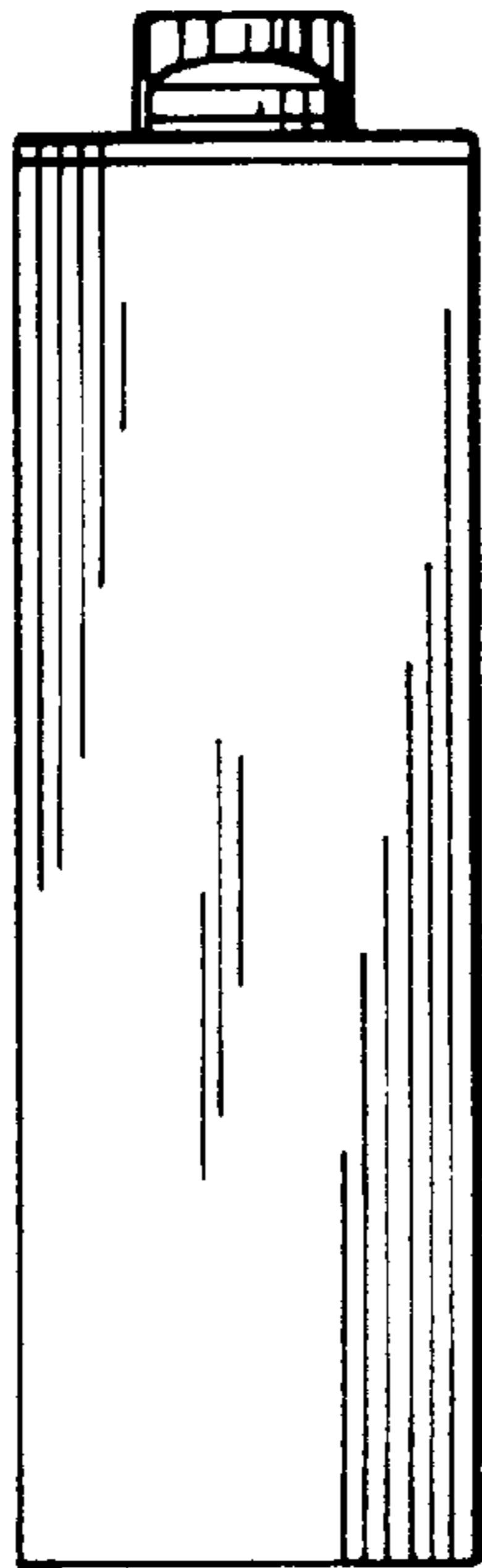

FIG. 11

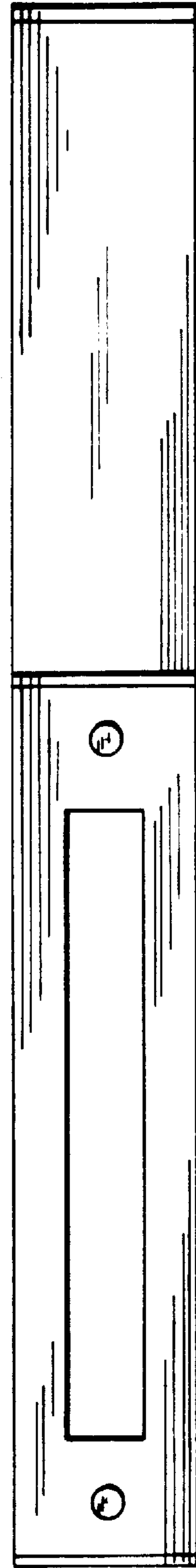

FIG. 12