



US00D398526S

# United States Patent [19]

Schwarz et al.

[11] **Patent Number: Des. 398,526**

[45] **Date of Patent: \*\*Sep. 22, 1998**

[54] **SIX-EDGE CONTAINER**

[75] Inventors: **Ingo Schwarz**, Meschede; **Christian Vogel**, Iserlohn, both of Germany

[73] Assignee: **Alcan Deutschland GmbH**, Gottingen, Germany

[\*\*] Term: **14 Years**

[21] Appl. No.: **77,205**

[22] Filed: **Sep. 29, 1997**

### [30] Foreign Application Priority Data

Jul. 14, 1997 [DE] Germany ..... M 97 06 550.1

[51] **LOC (6) Cl.** ..... **09-03**

[52] **U.S. Cl.** ..... **D9/431; D9/425; D9/430**

[58] **Field of Search** ..... D9/414, 424, 425, D9/428, 430, 431; 206/438, 557, 563, 564, 562; 220/651, 659, 662, 669-672

### [56] References Cited

#### U.S. PATENT DOCUMENTS

D. 288,295 2/1987 Holden ..... D9/425

D. 322,403 12/1991 Eaton ..... D9/425 X  
D. 374,819 10/1996 Wells ..... D9/452  
3,443,741 5/1969 Stockdale ..... D9/425 X  
4,911,083 3/1990 Considine ..... 206/562

*Primary Examiner*—Sandra L. Morris

*Assistant Examiner*—Nanda Bondade

*Attorney, Agent, or Firm*—Stevens, Davis, Miller & Mosher, L.L.P.

### [57] CLAIM

The ornamental design for a six-edge container, as shown and described.

### DESCRIPTION

FIG. 1 is an inside perspective view of the container showing the present design;  
FIG. 2 is an outside perspective view thereof;  
FIG. 3 is a top view thereof;  
FIG. 4 is a bottom view thereof;  
FIG. 5 is a front view thereof;  
FIG. 6 is a rear view thereof; and,  
FIG. 7 is a right side view thereof which is a mirror image of the left side view thereof.

**1 Claim, 3 Drawing Sheets**

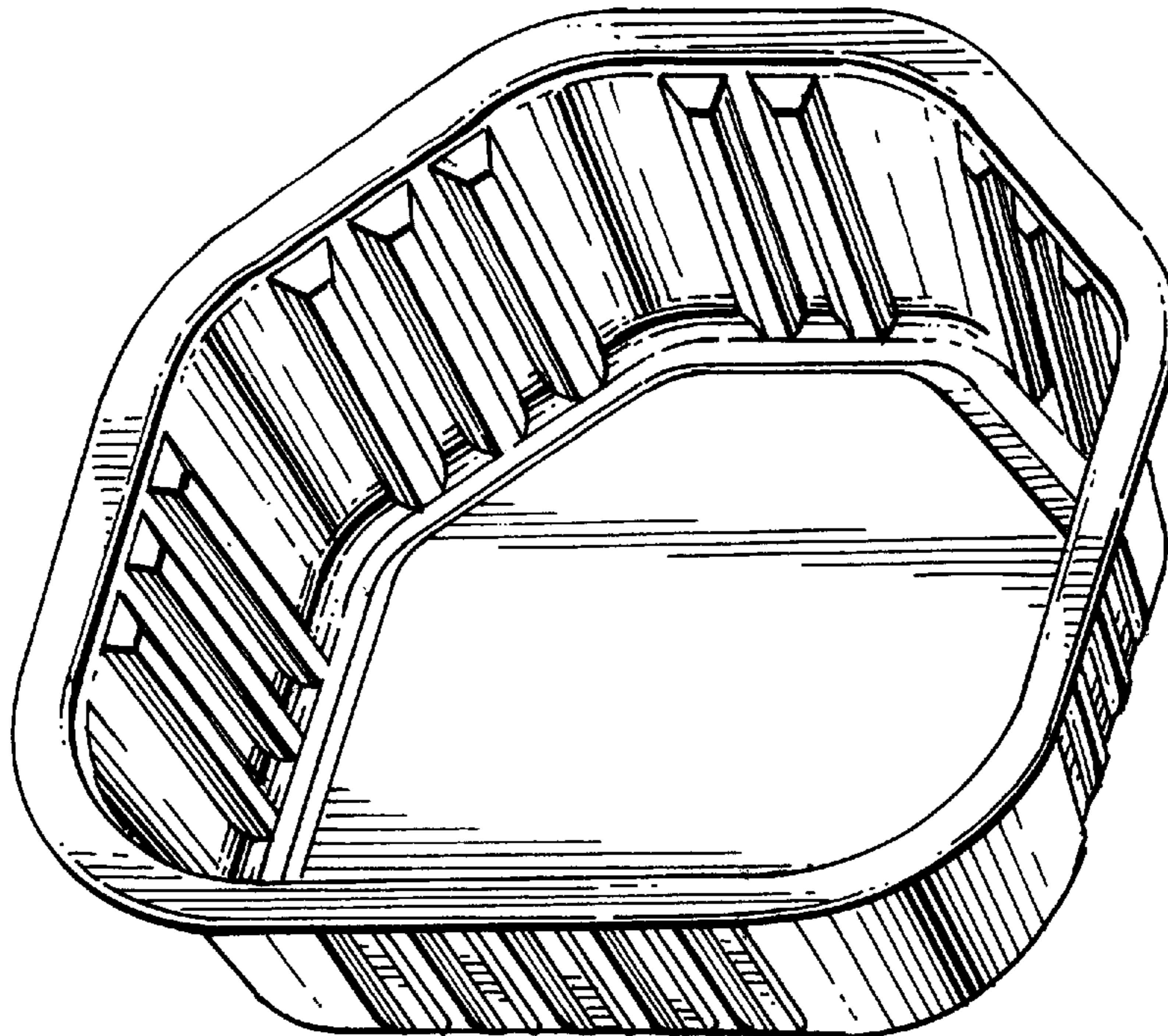

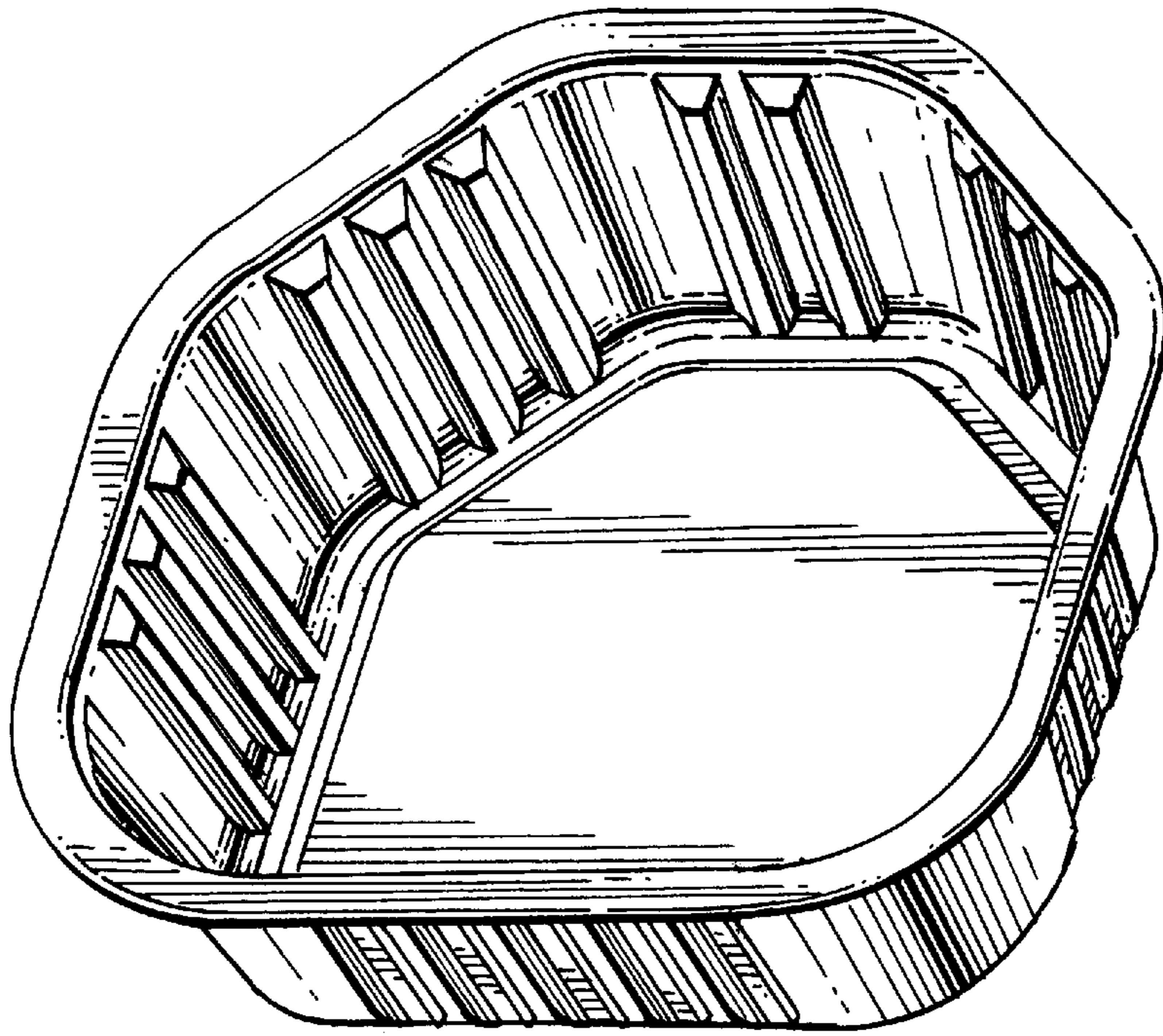

FIG. 1

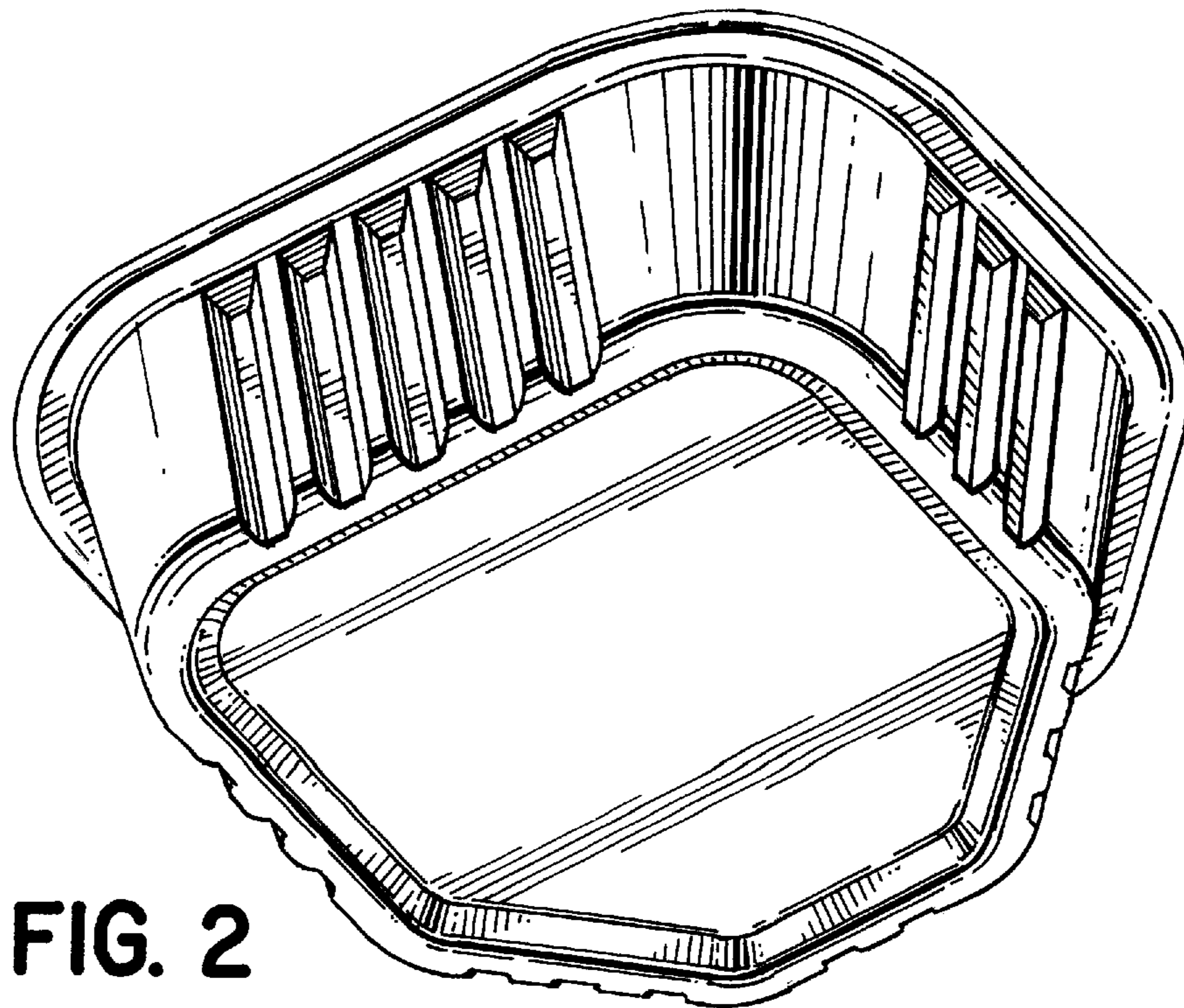

FIG. 2

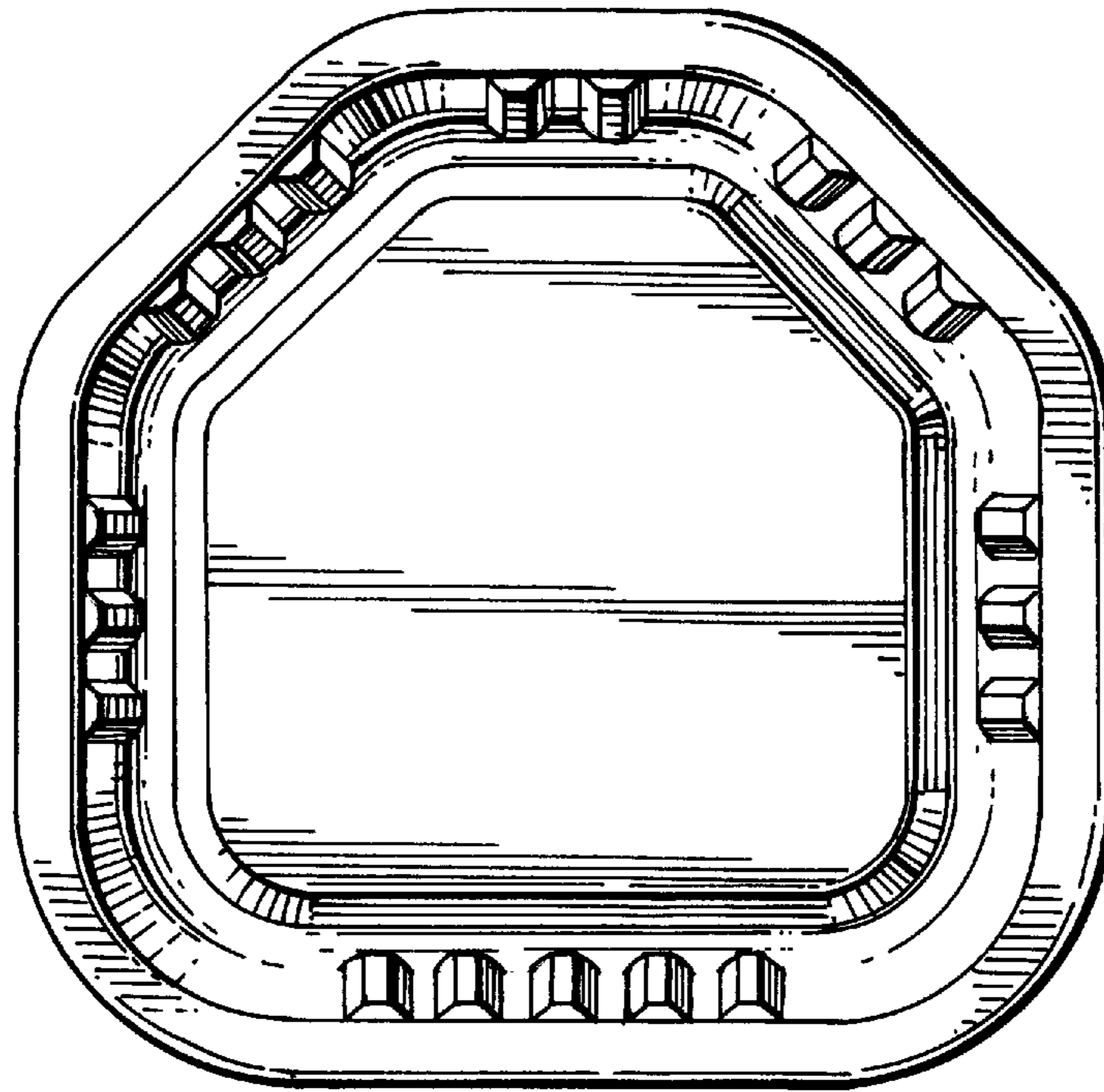

FIG. 3

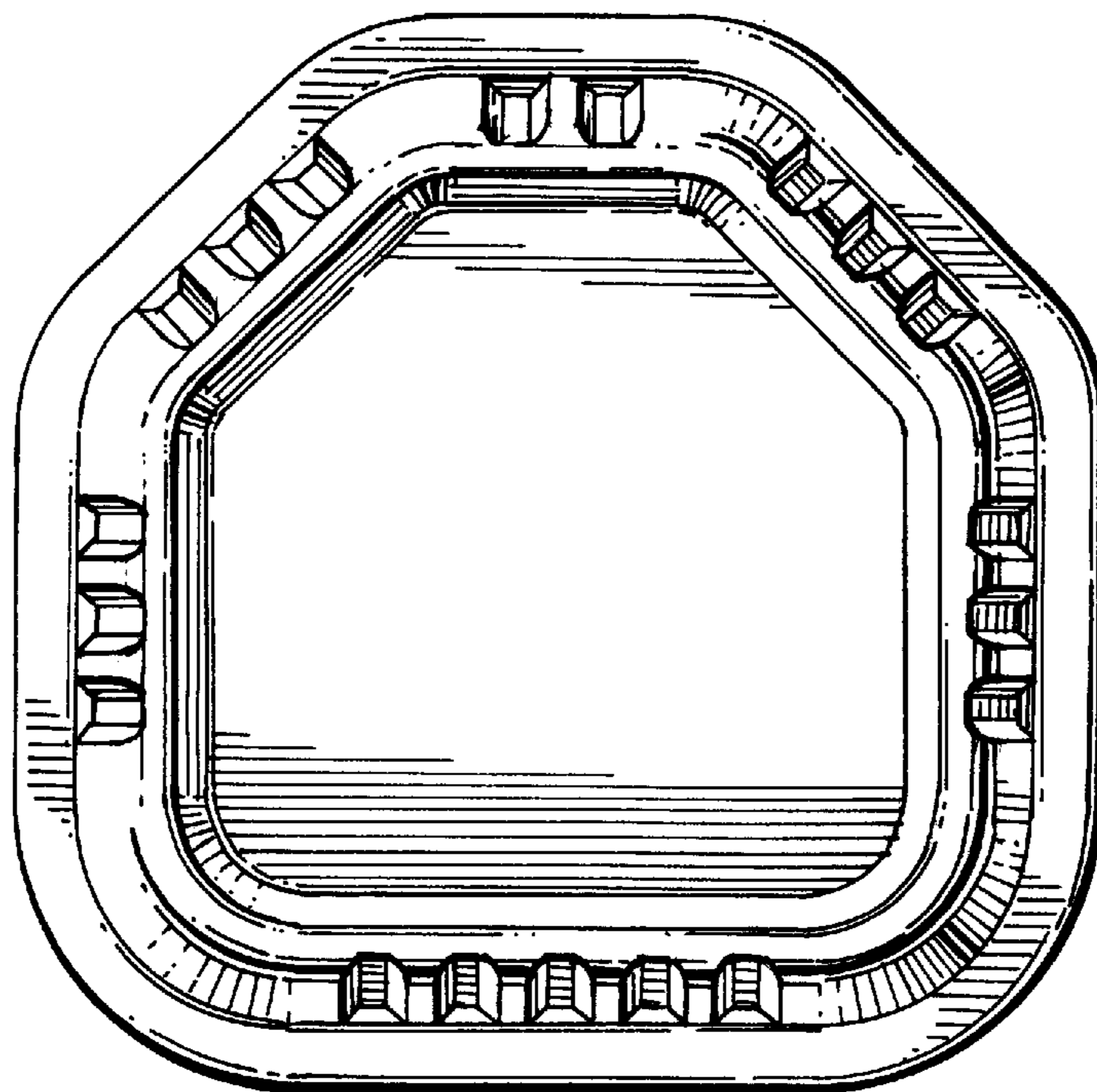
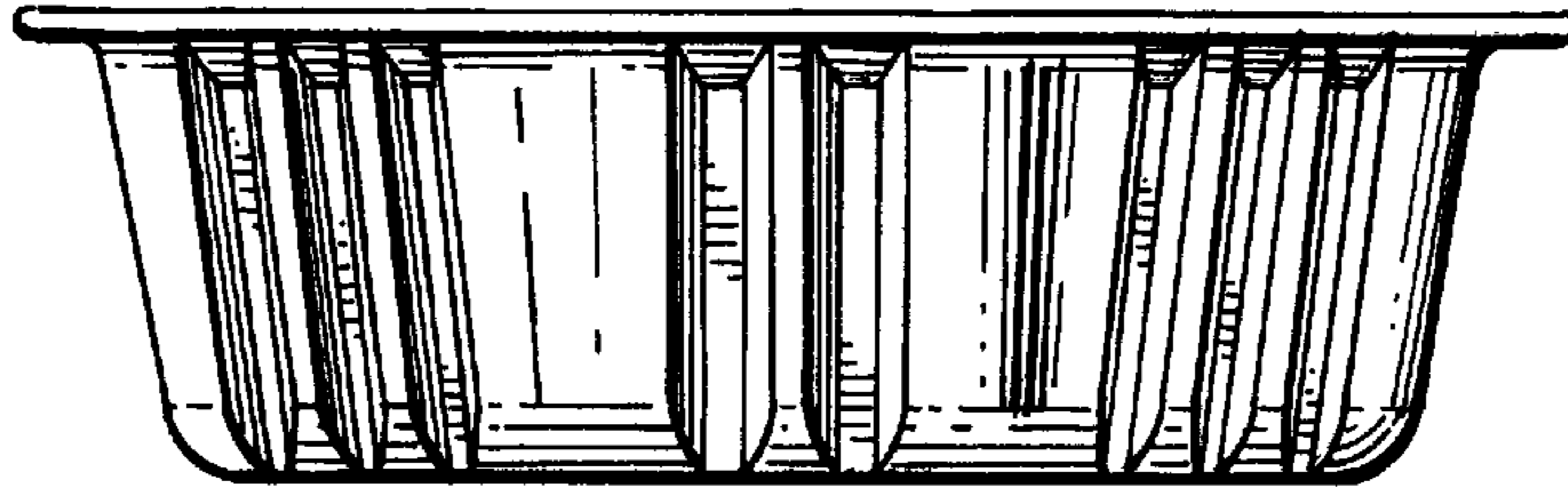
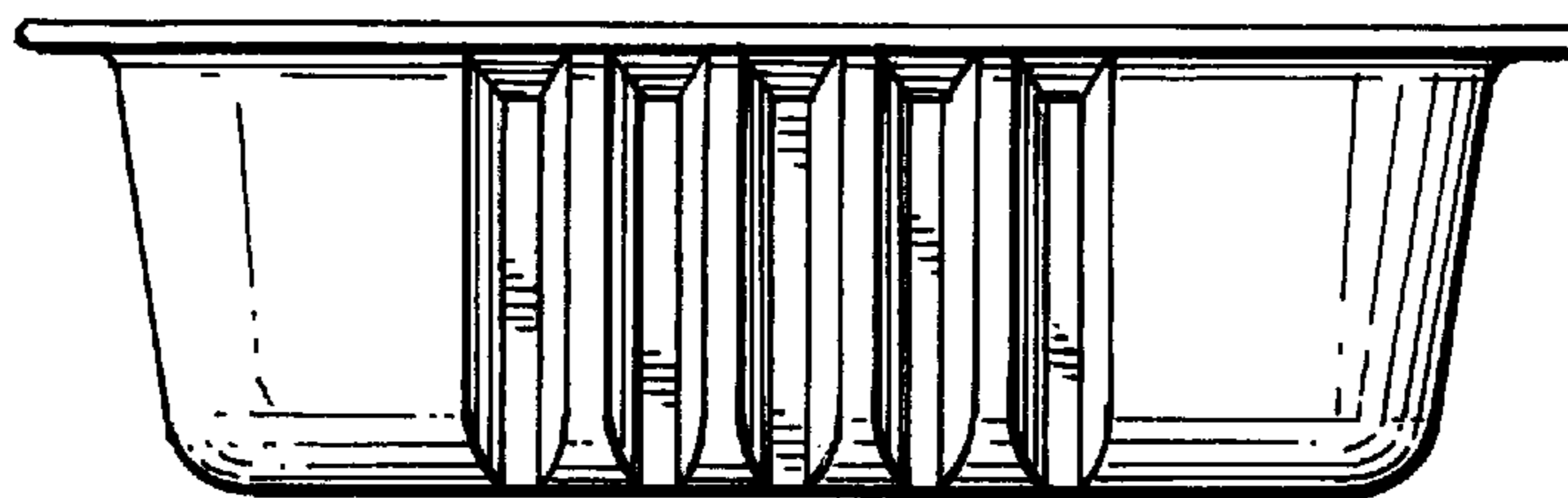

FIG. 4

**FIG. 5**



**FIG. 6**



**FIG. 7**

