



US00D398377S

# United States Patent [19]

Hundley et al.

[11] Patent Number: Des. 398,377

[45] Date of Patent: \*\*Sep. 15, 1998

[54] HANDLE FOR A PLUMBING FITTING

[75] Inventors: **Jill E. Hundley; Mary J. Reid**, both of Sheboygan, Wis.

[73] Assignee: **Kohler Co.**, Kohler, Wis.

[\*\*] Term: **14 Years**

[21] Appl. No.: **72,901**

[22] Filed: **Jun. 9, 1997**

### Related U.S. Application Data

[62] Division of Ser. No. 49,422, Jan. 24, 1996, Pat. No. Des. 385,620.

[51] LOC (6) Cl. .... **23-01**

[52] U.S. Cl. .... **D23/252**

[58] Field of Search ..... D23/238-243,  
D23/250-254; D8/300-308; D21/102; 4/675-678;  
16/110 R, 118, 121, 123, 125

### [56] References Cited

#### U.S. PATENT DOCUMENTS

D. 178,859 10/1956 Beil ..... D8/308  
D. 271,560 11/1983 Valli ..... D8/308

(List continued on next page.)

#### OTHER PUBLICATIONS

Undated Altman catalog ad showing "Suite 40" faucet handles and escutcheon, admitted prior art.

(List continued on next page.)

*Primary Examiner*—Louis S. Zarfes

*Assistant Examiner*—Eric Watterson

*Attorney, Agent, or Firm*—Quarles & Brady

### [57] CLAIM

The ornamental design for a handle for a plumbing fitting, as shown and described.

### DESCRIPTION

FIG. 1 is a right, top, front perspective view of a handle for a plumbing fitting embodying our new design;

FIG. 2 is a front elevational view thereof;  
FIG. 3 is a rear elevational view thereof;  
FIG. 4 is a left side elevational view thereof;  
FIG. 5 is a right side elevational view thereof;  
FIG. 6 is a top plan view thereof;  
FIG. 7 is a front elevational view of a second embodiment which is essentially identical to the first embodiment but for a spacer and truncated escutcheon. The spacer has identical front and rear views;  
FIG. 8 is a rear elevation view thereof;  
FIG. 9 is a left side elevational view thereof;  
FIG. 10 is a right side elevational view thereof;  
FIG. 11 is a front elevational view of a third embodiment which is essentially identical to the second embodiment but for a decorative spacer. The spacer is identical in front and rear views;  
FIG. 12 is a left, top, front perspective view of a fourth embodiment which has a mirror image spiral from the first embodiment;  
FIG. 13 is a top plan view thereof;  
FIG. 14 is a right, top, front perspective view of a fifth embodiment;  
FIG. 15 is a front elevational view thereof;  
FIG. 16 is a rear elevational view thereof;  
FIG. 17 is a left side elevational view thereof;  
FIG. 18 is a right side elevational view thereof;  
FIG. 19 is a top plan view thereof;  
FIG. 20 is a front elevational view of a sixth embodiment which is essentially identical to the fifth embodiment but for a spacer and truncated escutcheon. The spacer has identical front and rear views;  
FIG. 21 is a rear elevational view thereof;  
FIG. 22 is a left side elevational view thereof;  
FIG. 23 is a right side elevational view thereof;  
FIG. 24 is a front elevational view of a seventh embodiment which is essentially identical to the sixth but for a decorative spacer. The spacer is identical in front and rear view;  
FIG. 25 is a left, top, front perspective view of an eighth embodiment which has a mirror image spiral from the fifth embodiment; and,  
FIG. 26 is a top plan view thereof.  
The dotted line representations of an escutcheon in FIG. 7-11 and 20-24 are for purposes of illustration only, and form no part of the claimed design.  
FIG. 13 is a top plan view thereof;

1 Claim, 14 Drawing Sheets

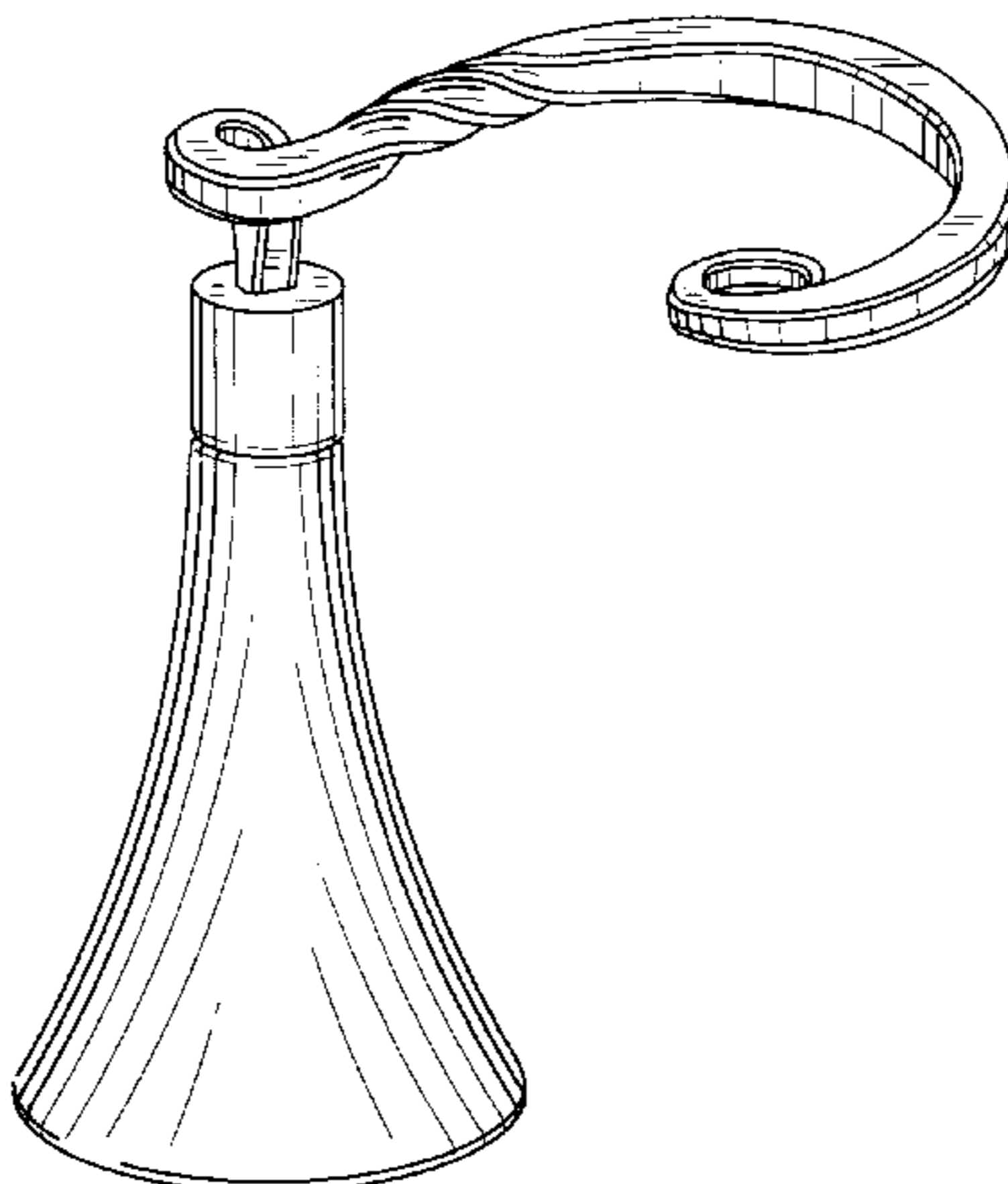

U.S. PATENT DOCUMENTS

D. 271,561 11/1983 Valli ..... D8/308  
D. 300,719 4/1989 Rhoades et al. .... D8/308  
D. 348,509 7/1994 Bollenbacher ..... D6/550  
D. 349,328 8/1994 Bollenbacher ..... D23/252

OTHER PUBLICATIONS

Undated Jacob Delafon catalog ad showing a “Centenaire”  
faucet handle, admitted prior art.  
Undated Harden catalog ad, p. 25, showing a “56 Series”  
faucet handle escutcheon, admitted prior art.  
1989 WICO catalog ad showing a “Retro” faucet handle  
escutcheon.

FIG. 2

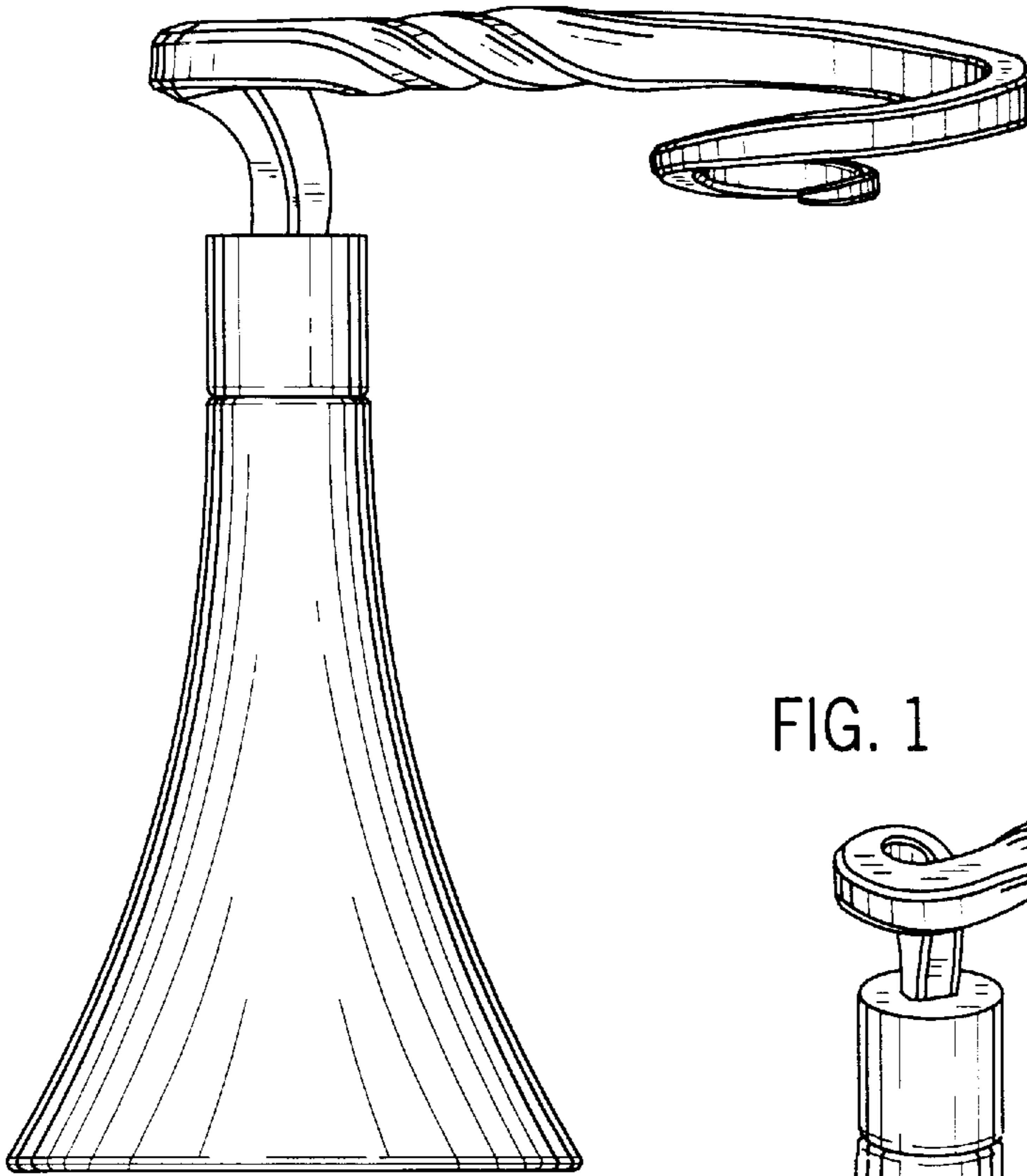
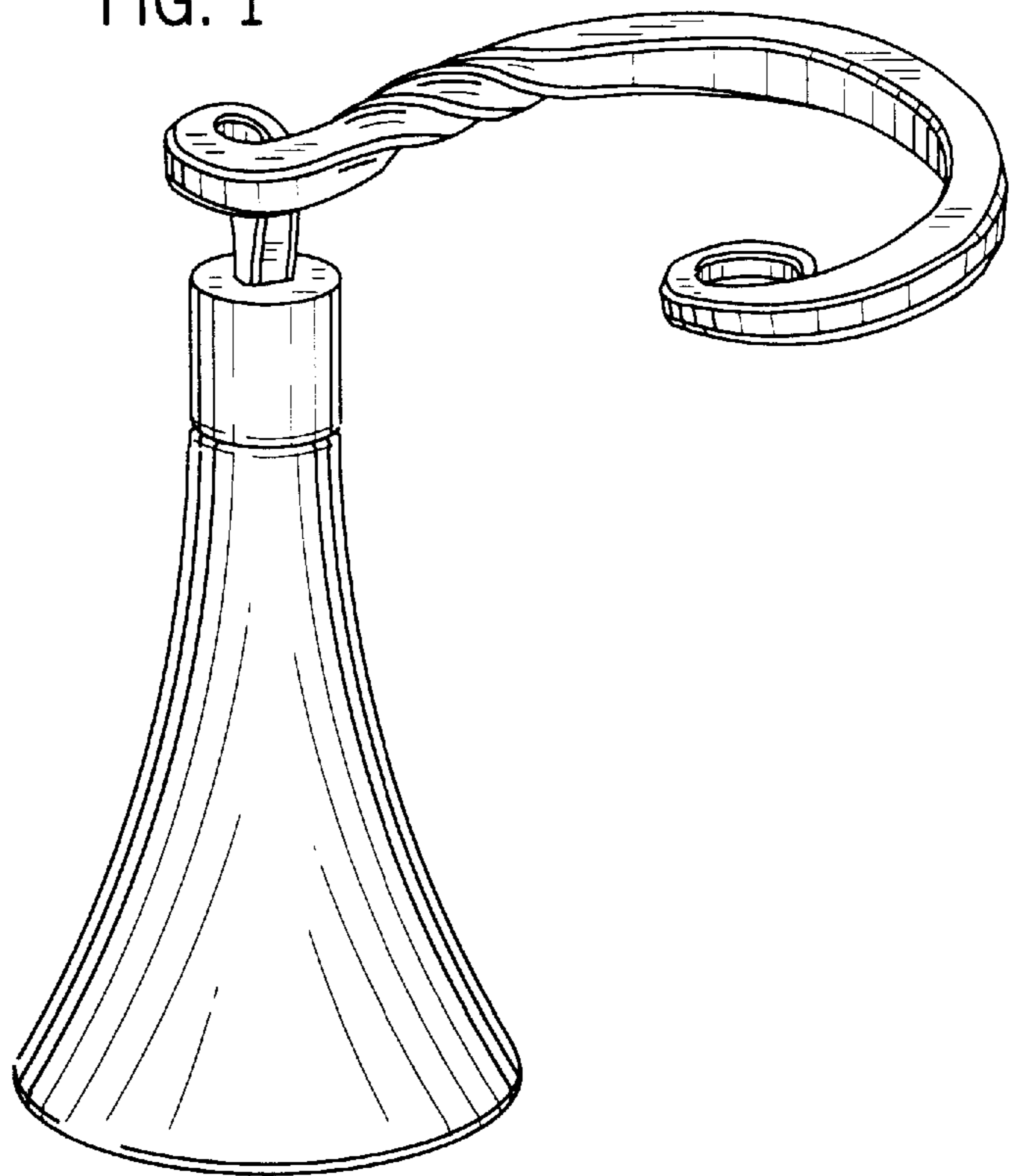

FIG. 1



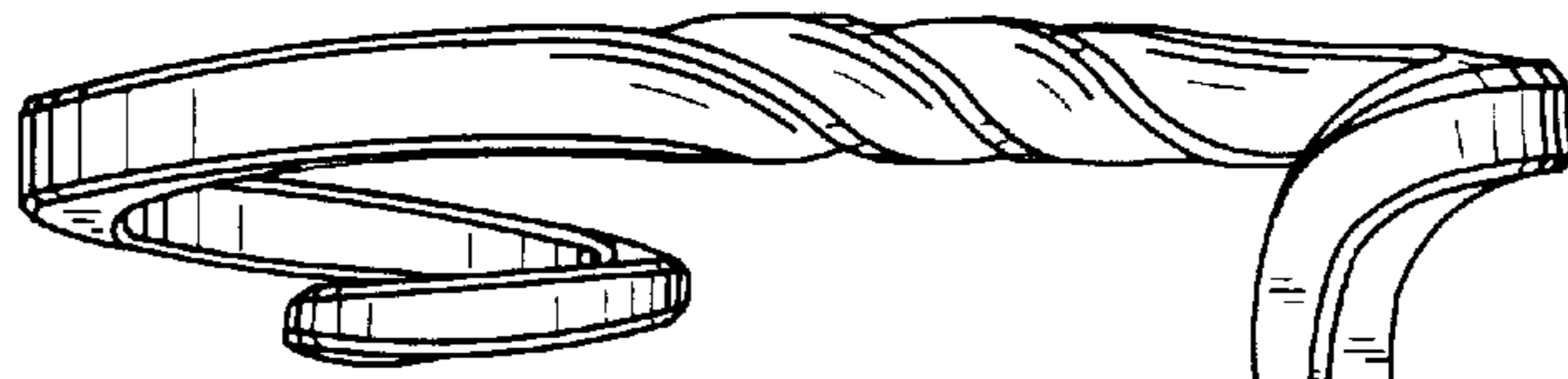

FIG. 3

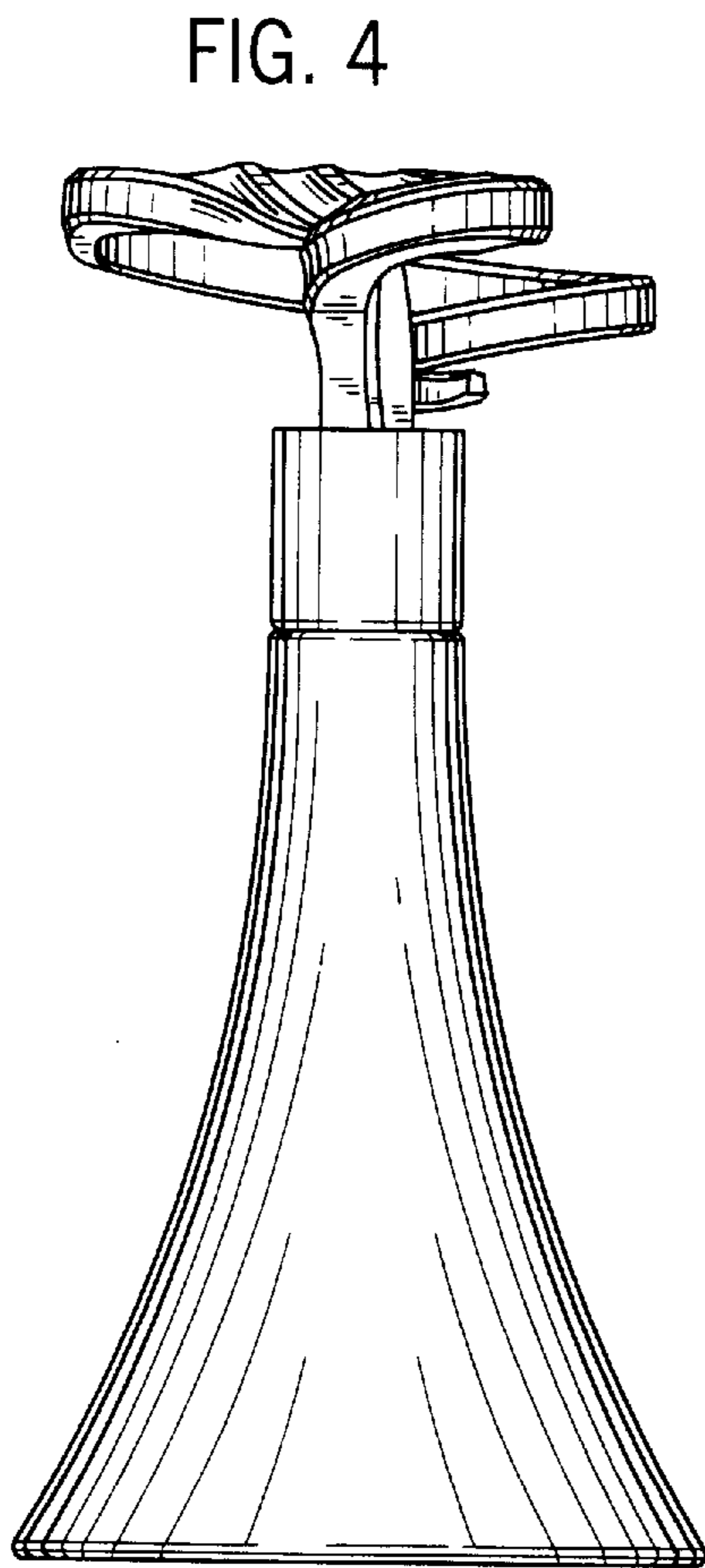

FIG. 4

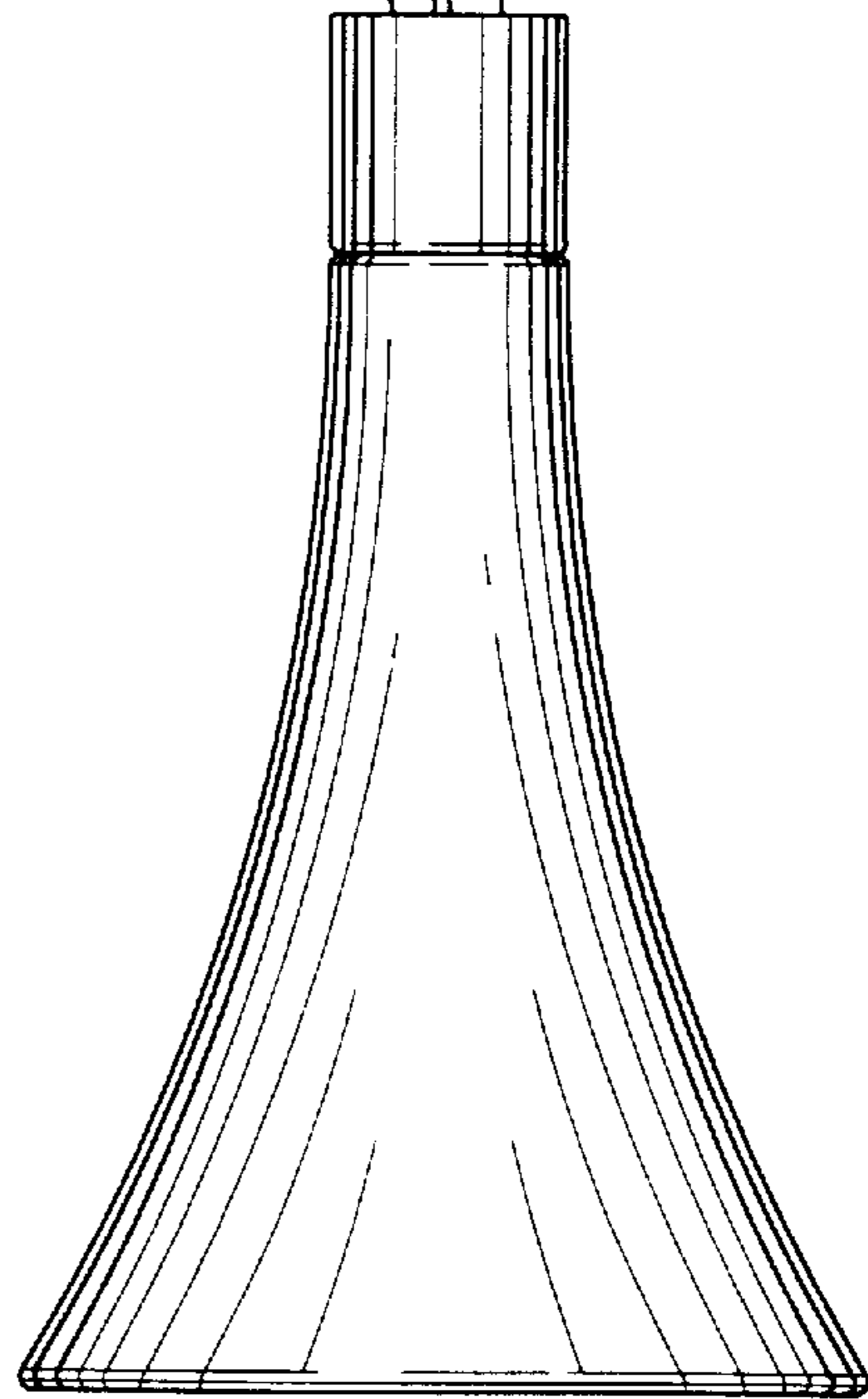

FIG. 5

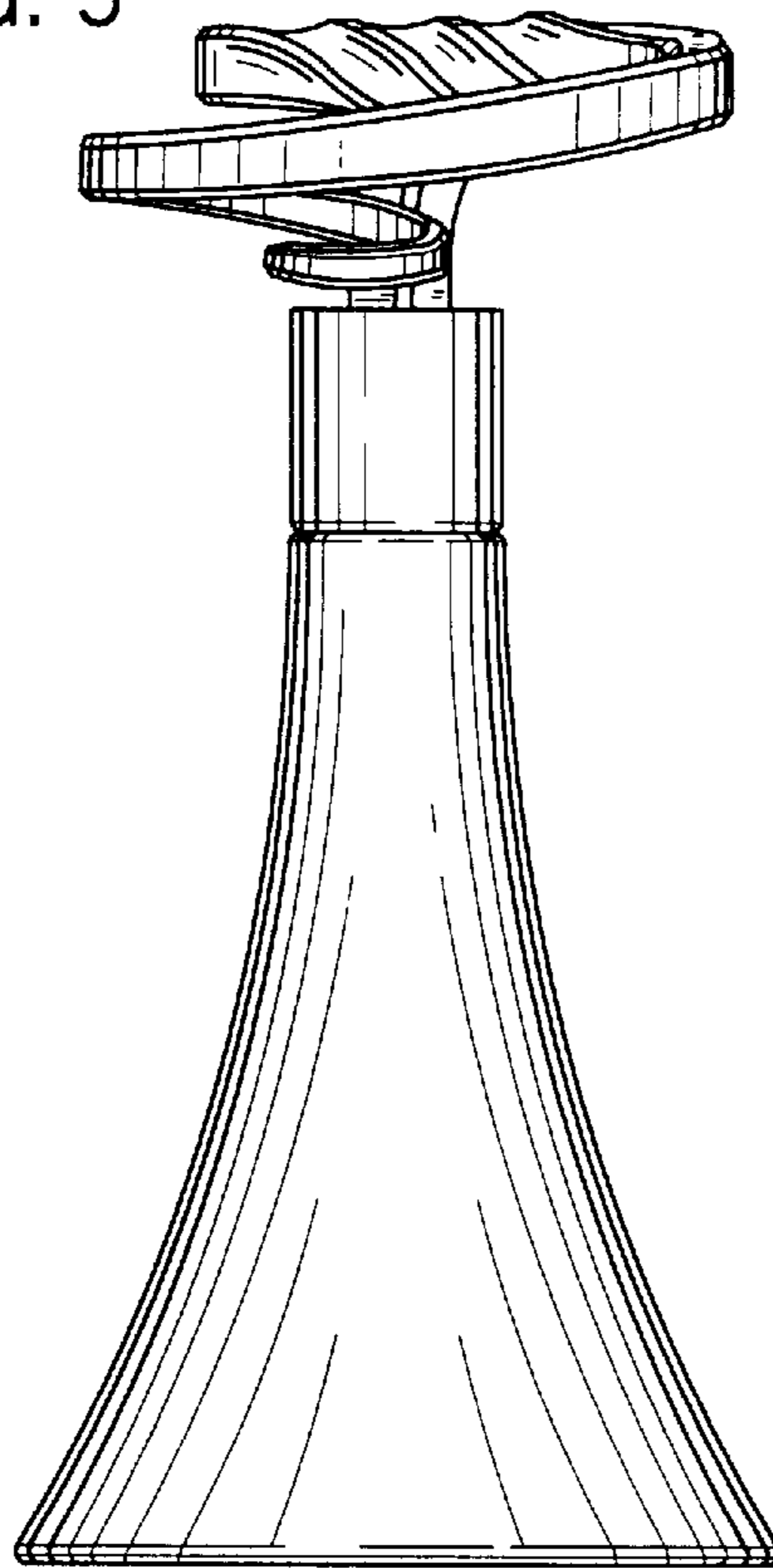

FIG. 6

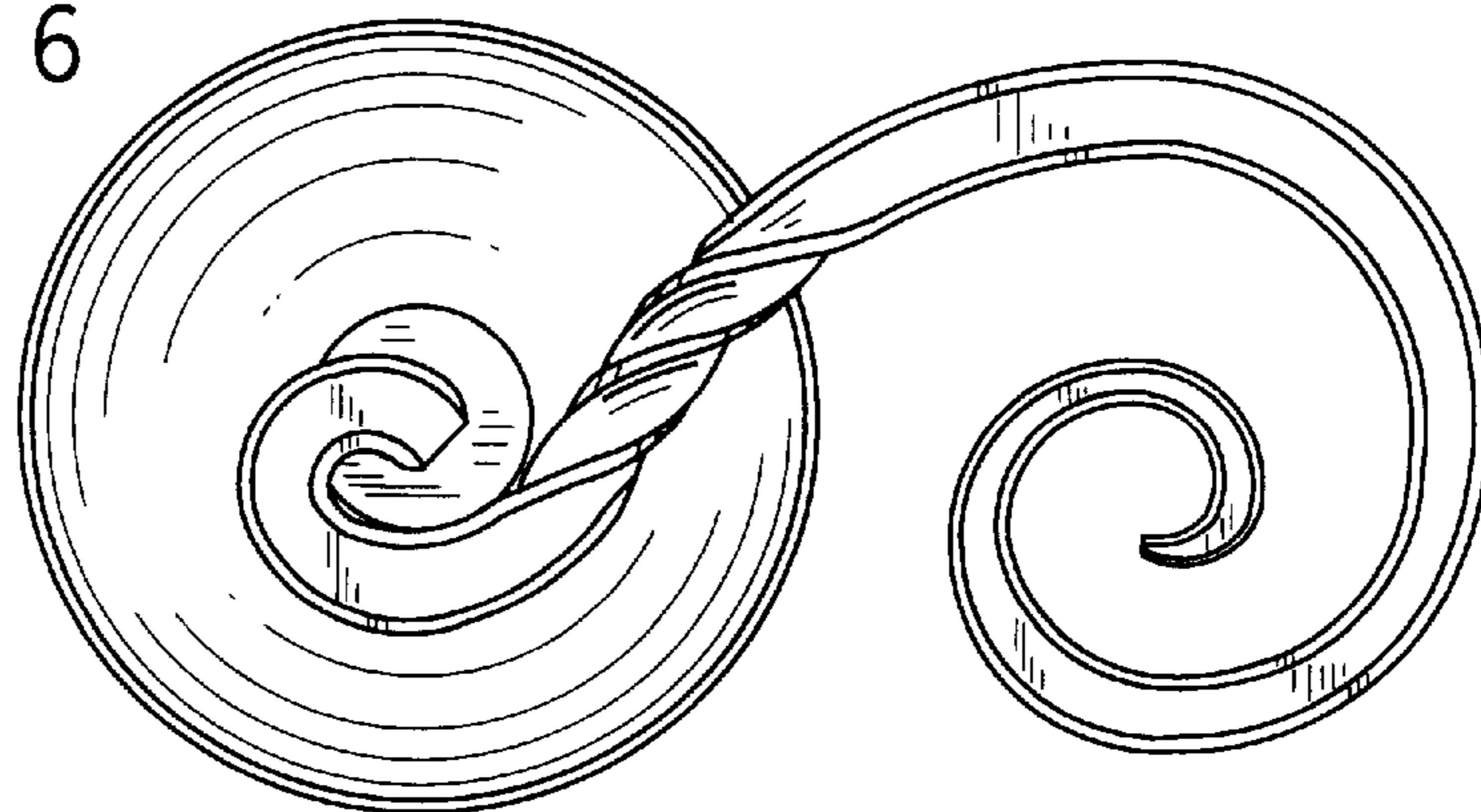

FIG. 7

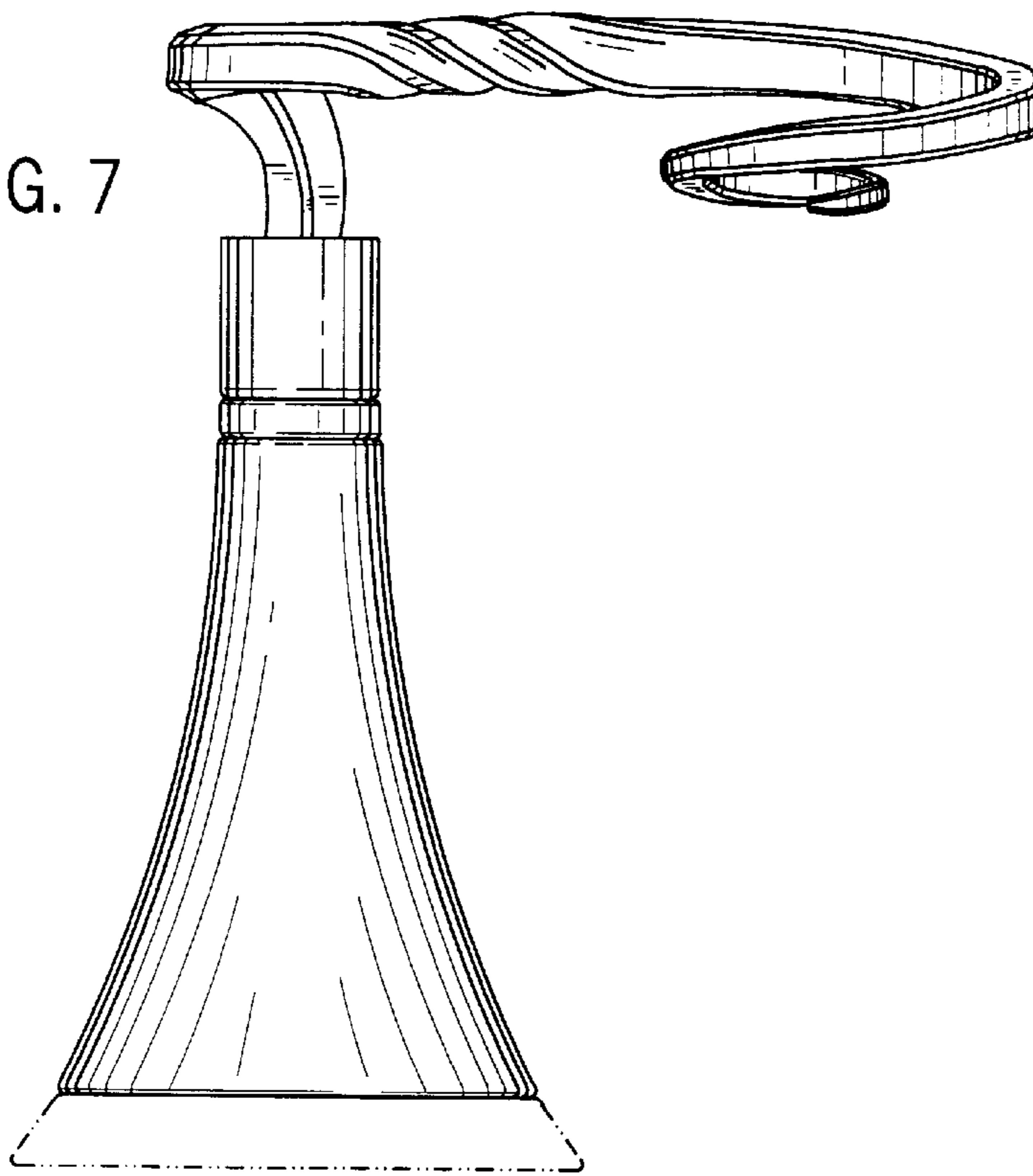

FIG. 8

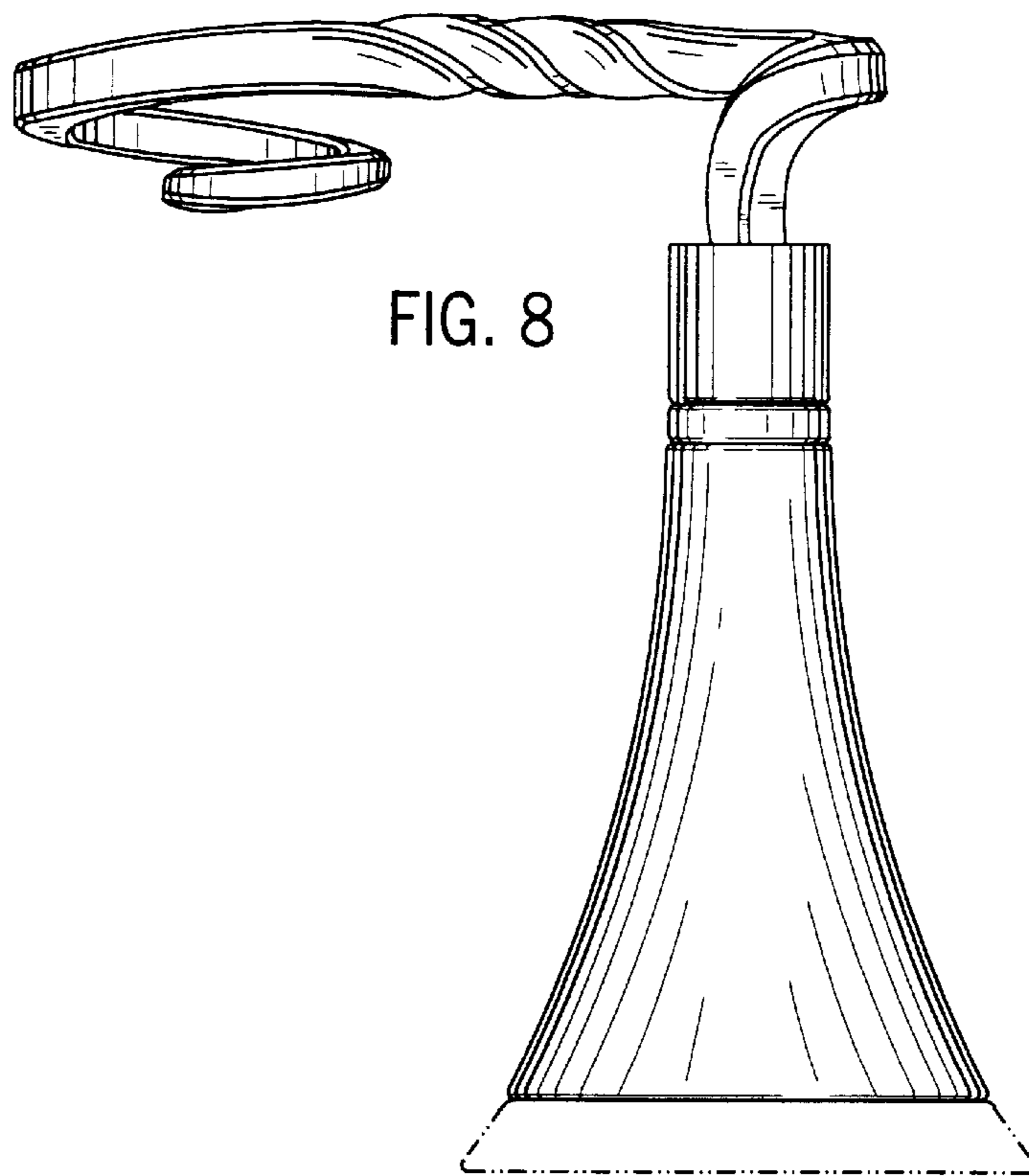

FIG. 9

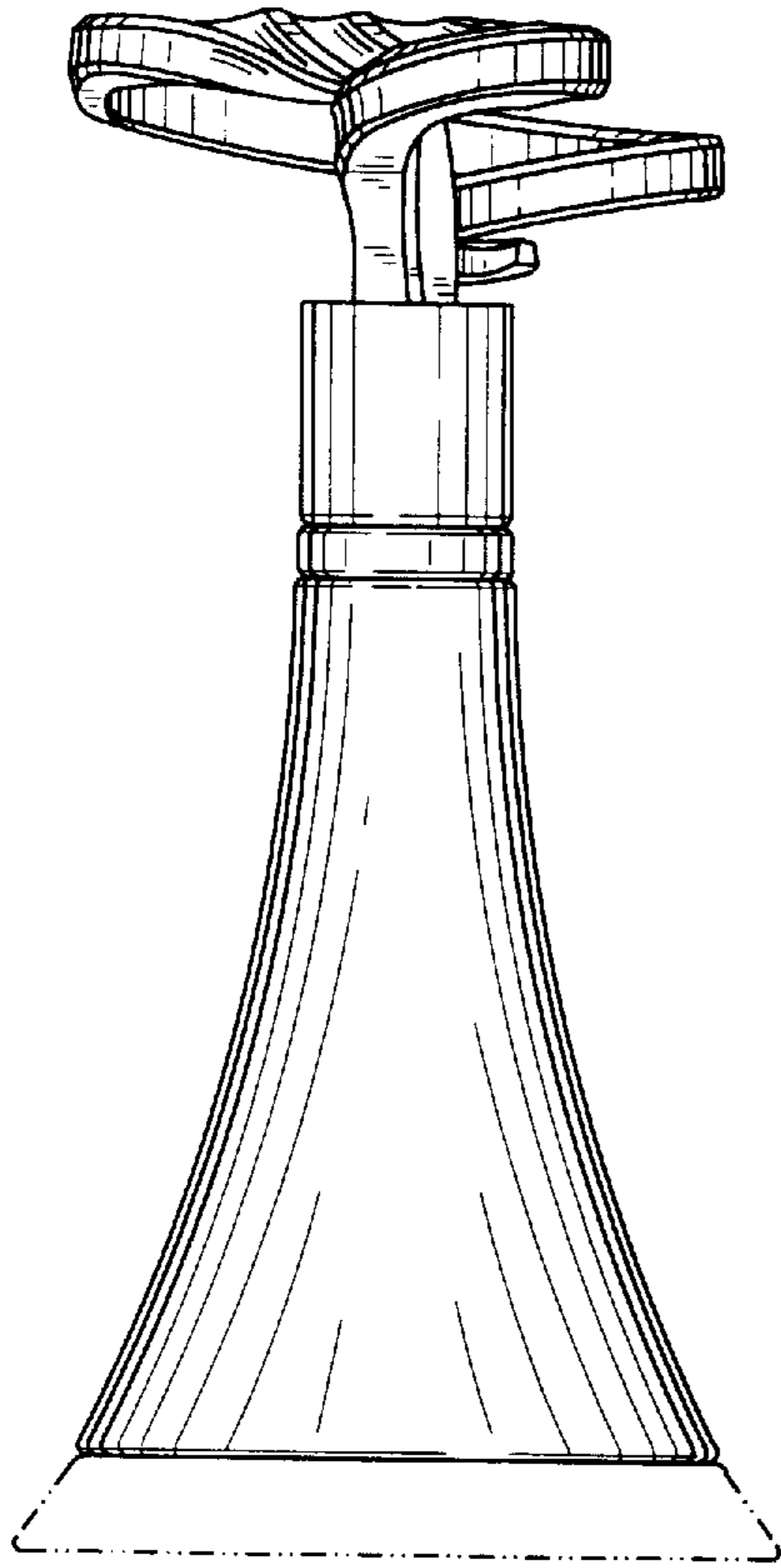

FIG. 10

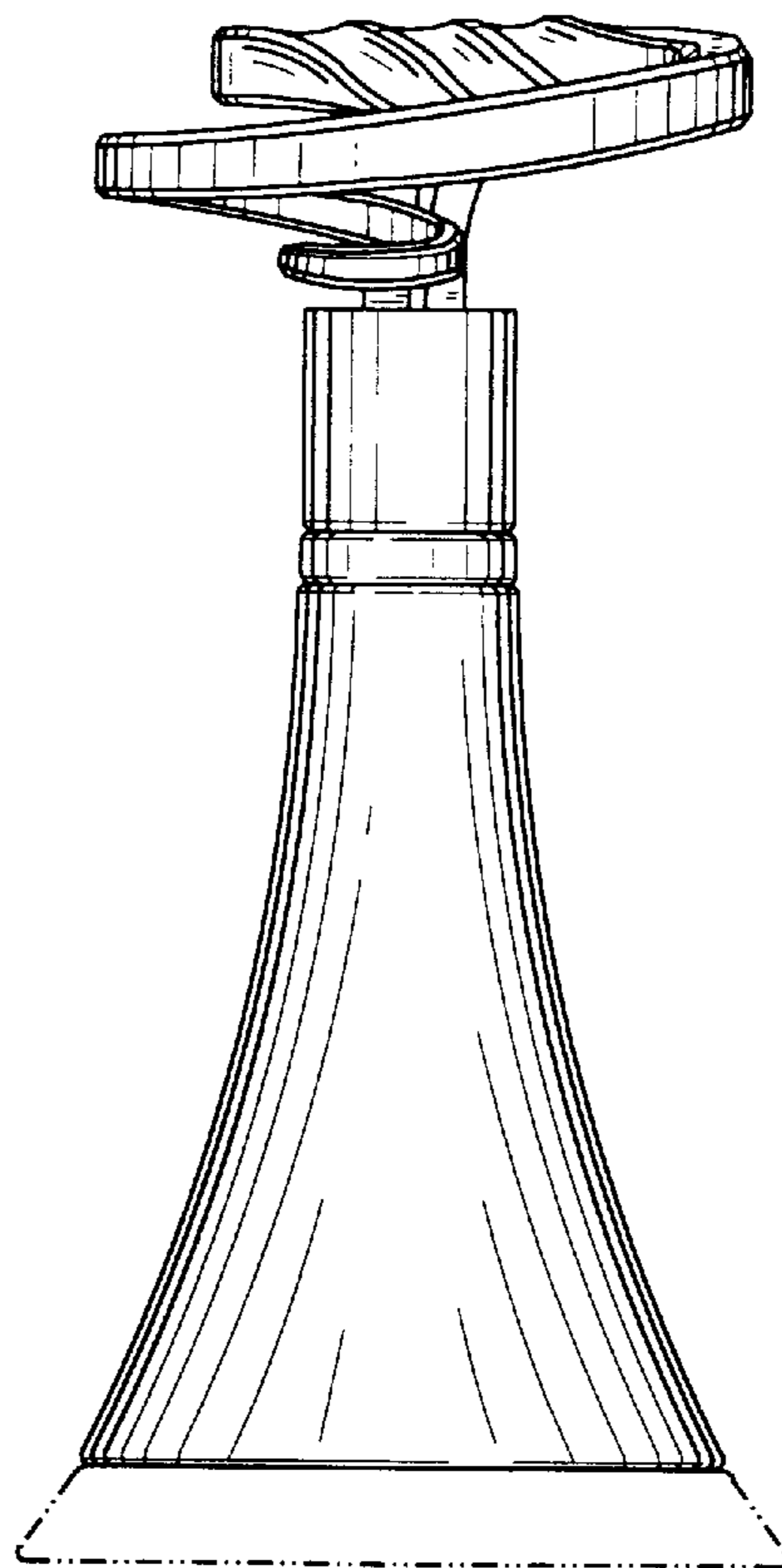
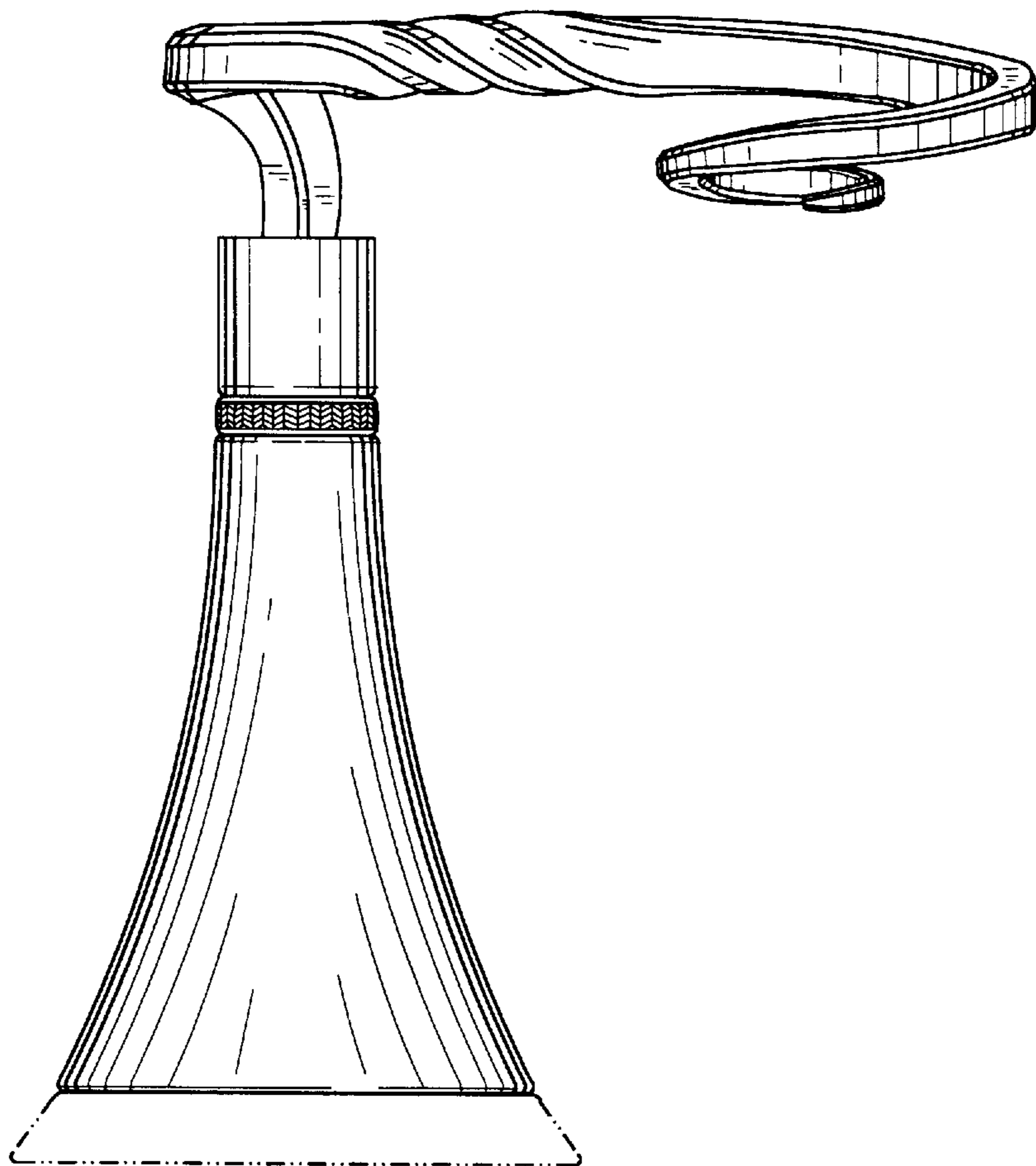

FIG. 11





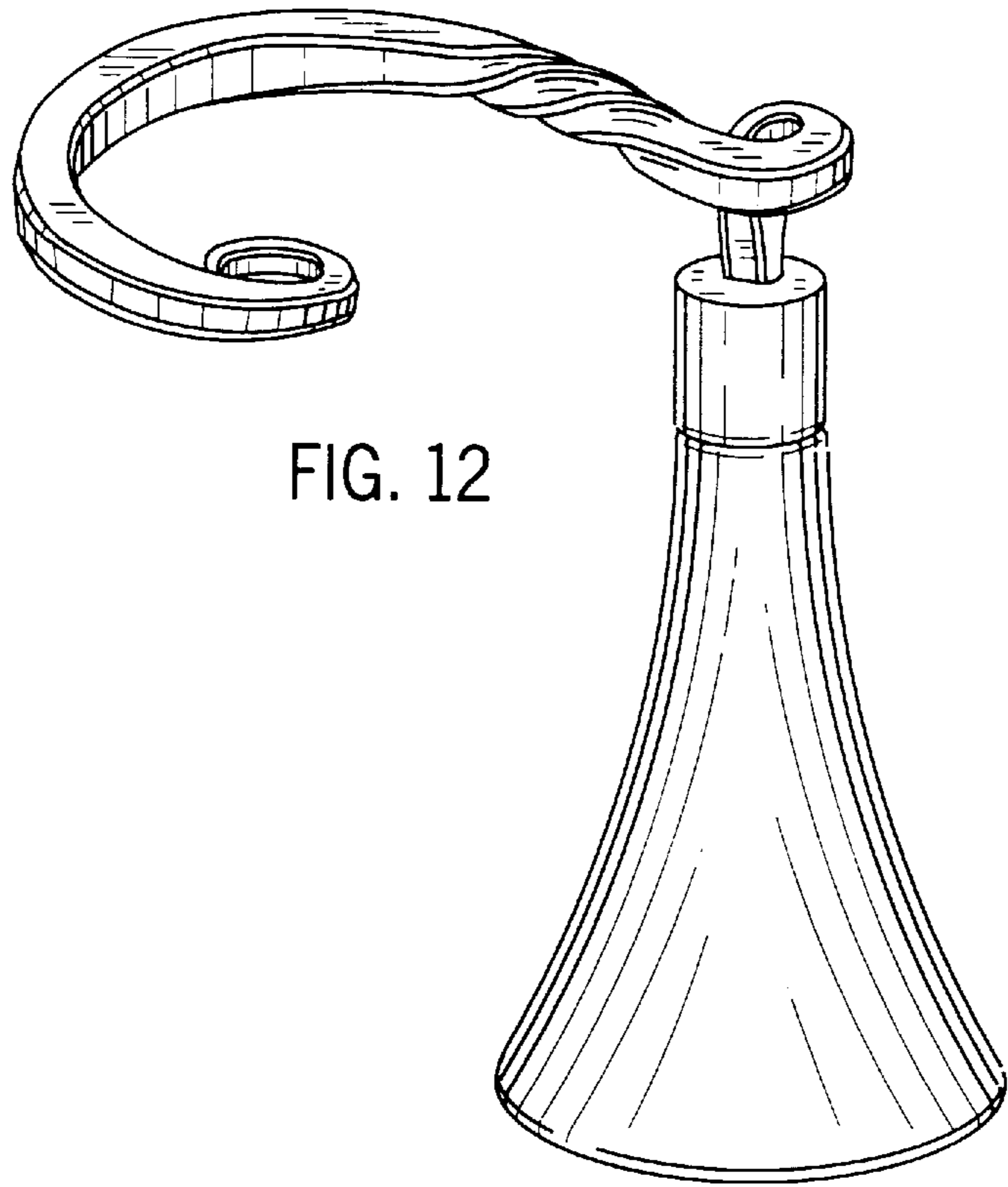

FIG. 13

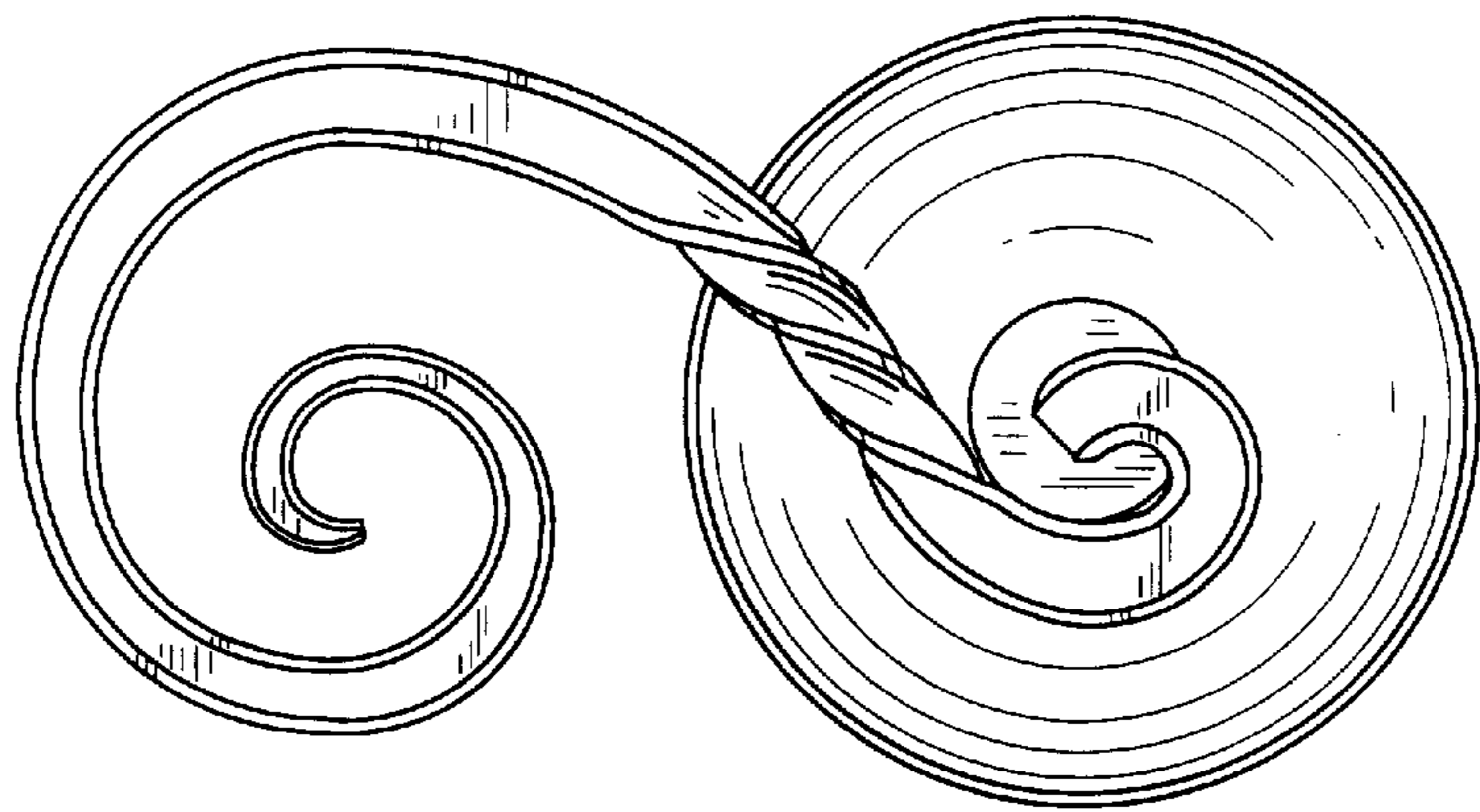

FIG.15

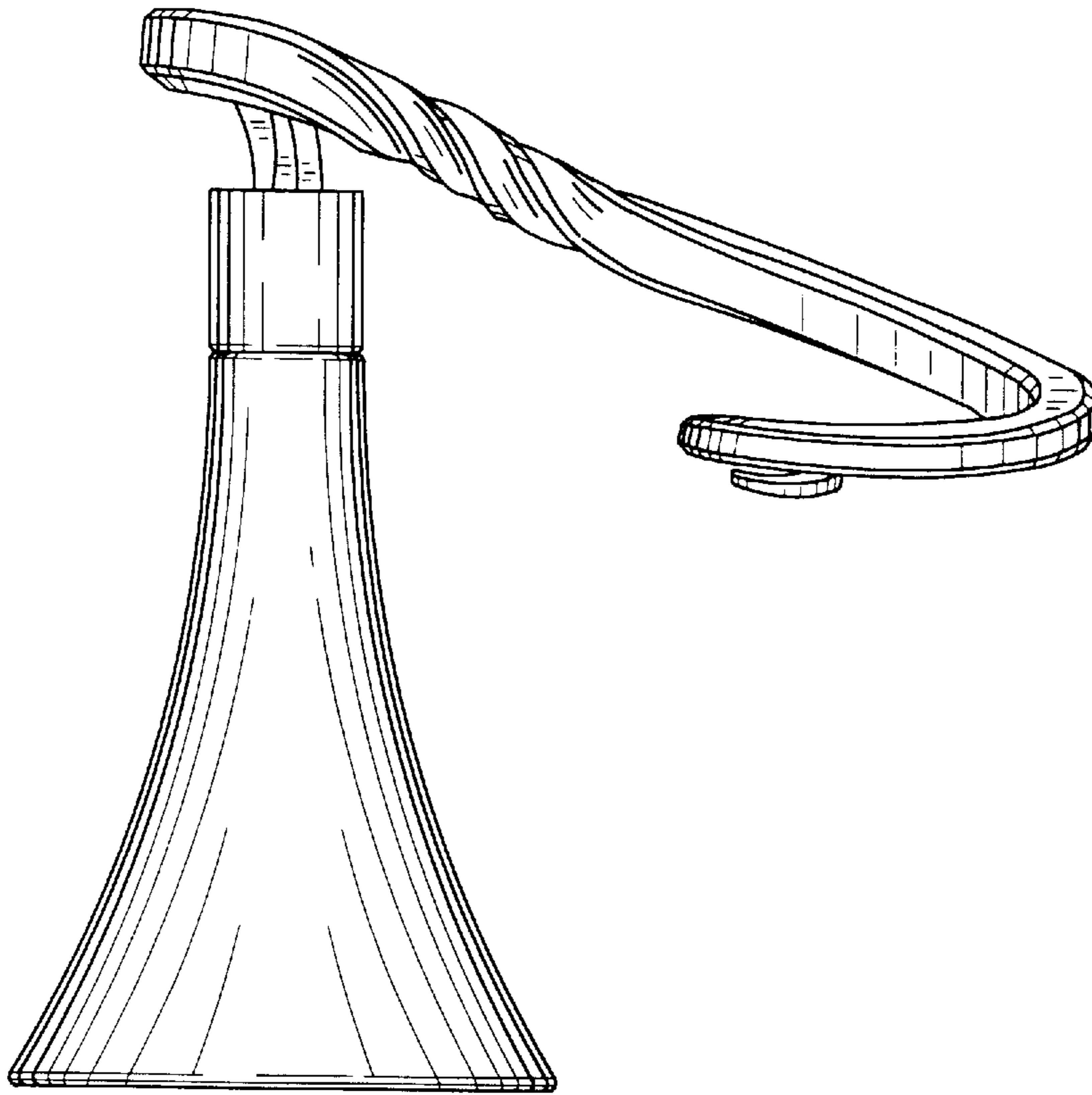

FIG.14

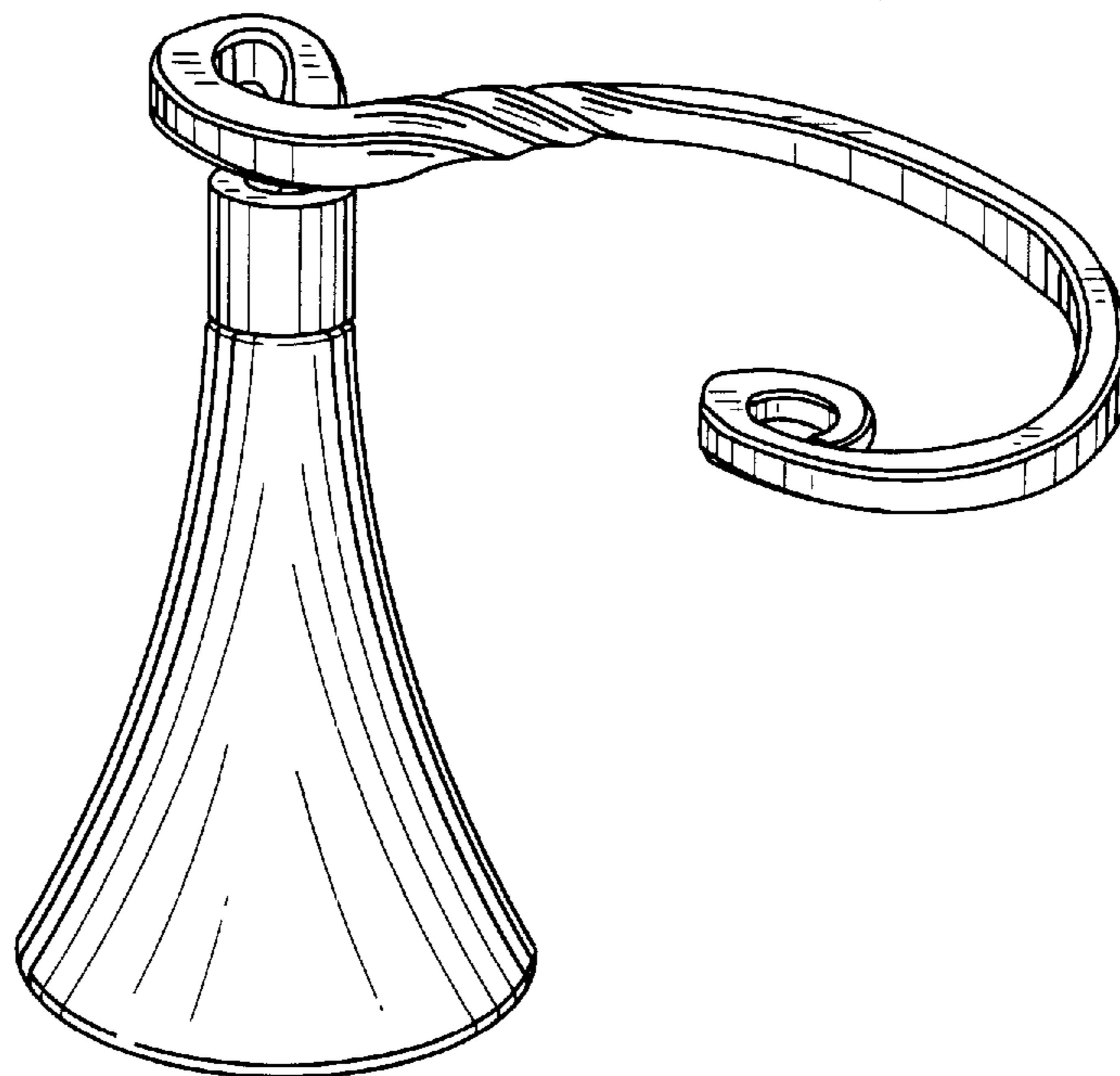

FIG. 16

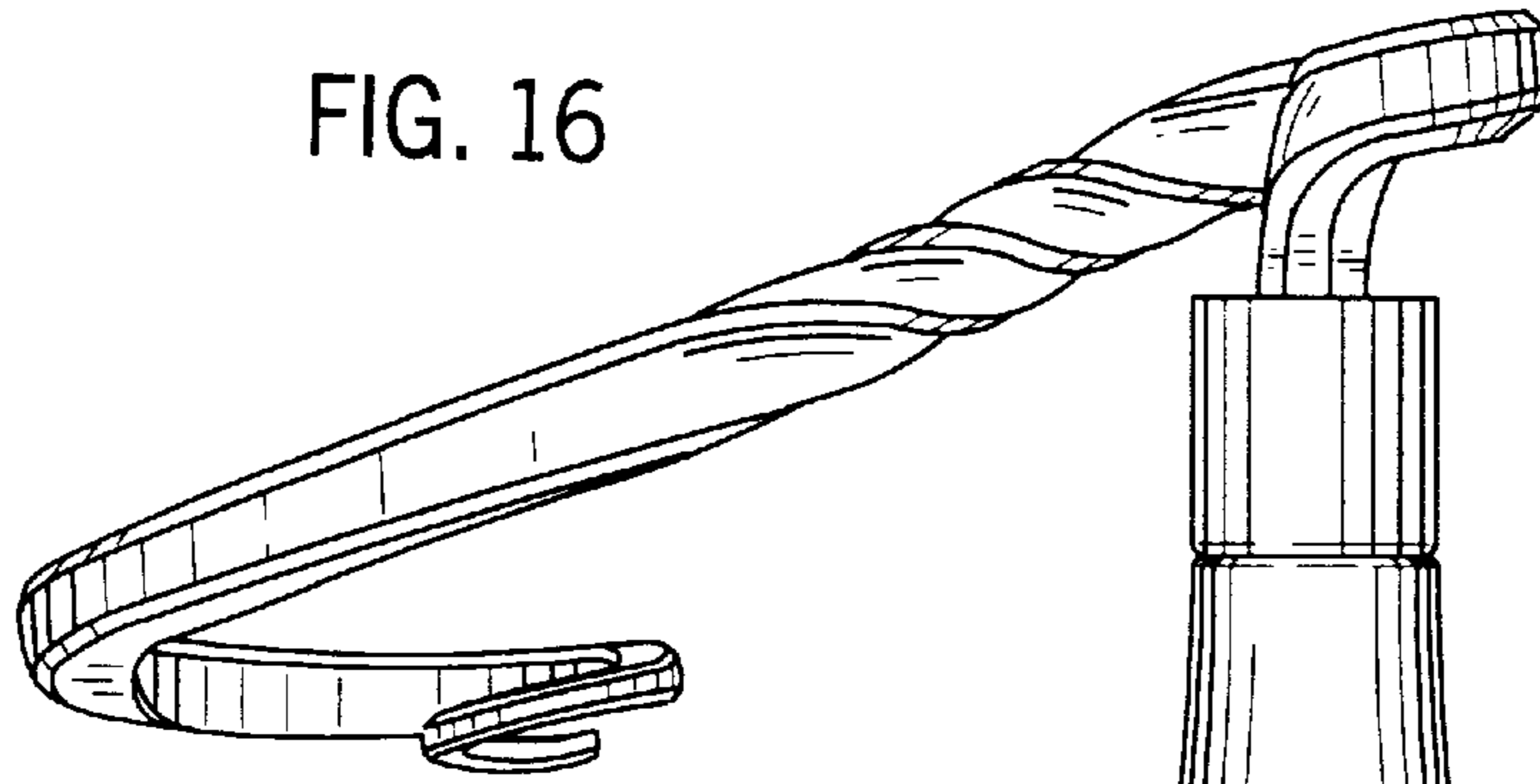

FIG. 17

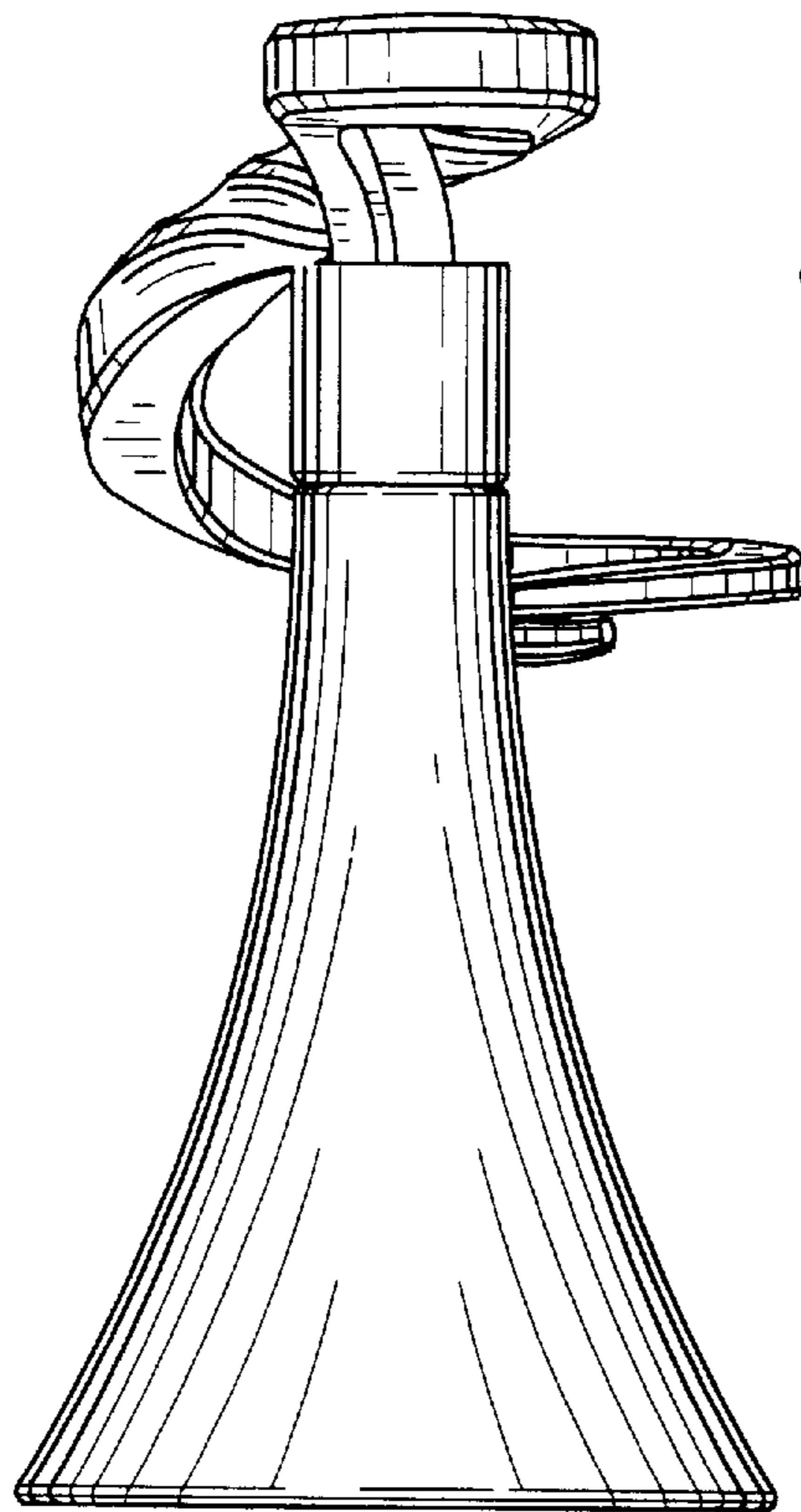

FIG. 18

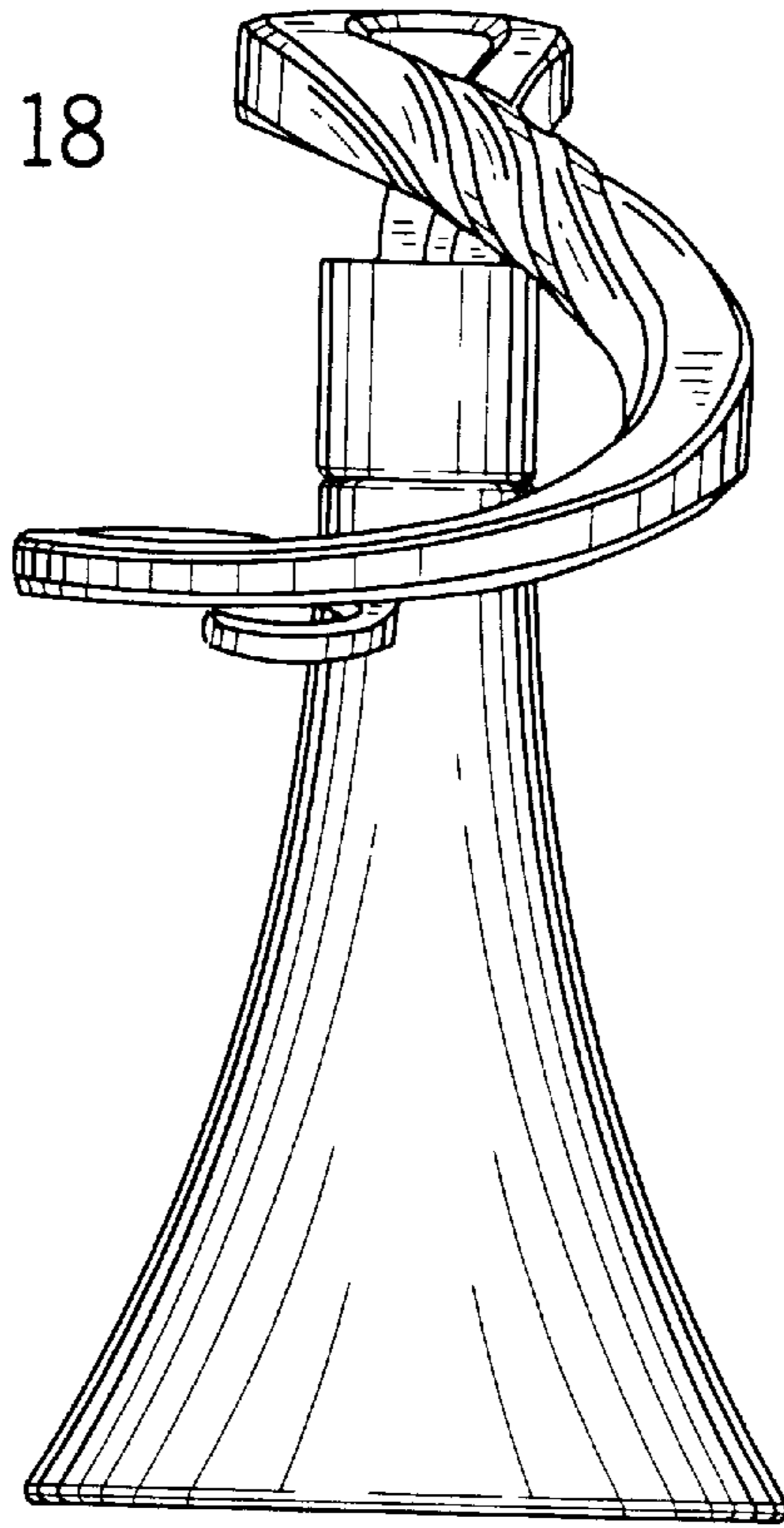

FIG. 19

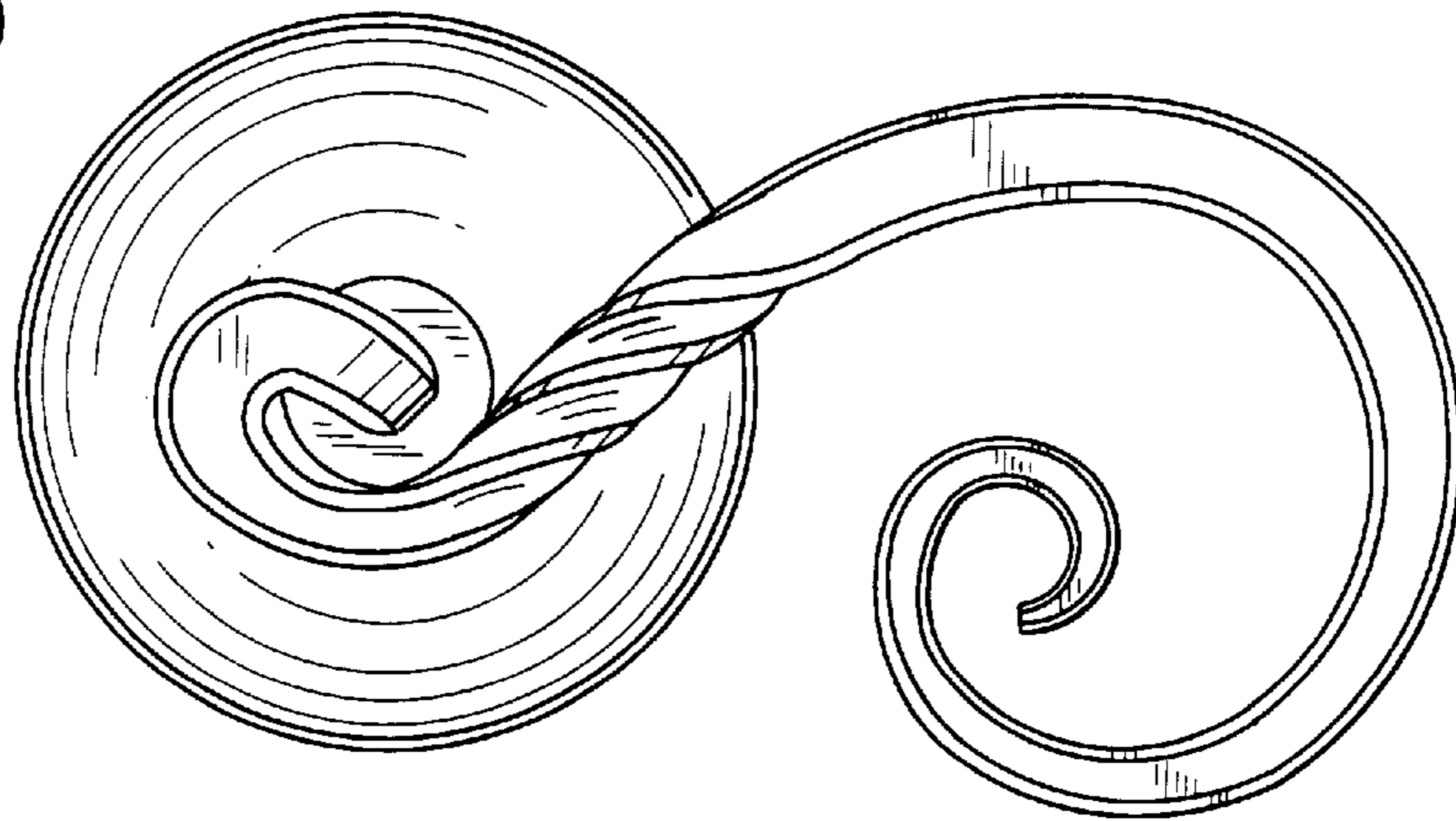

FIG. 20

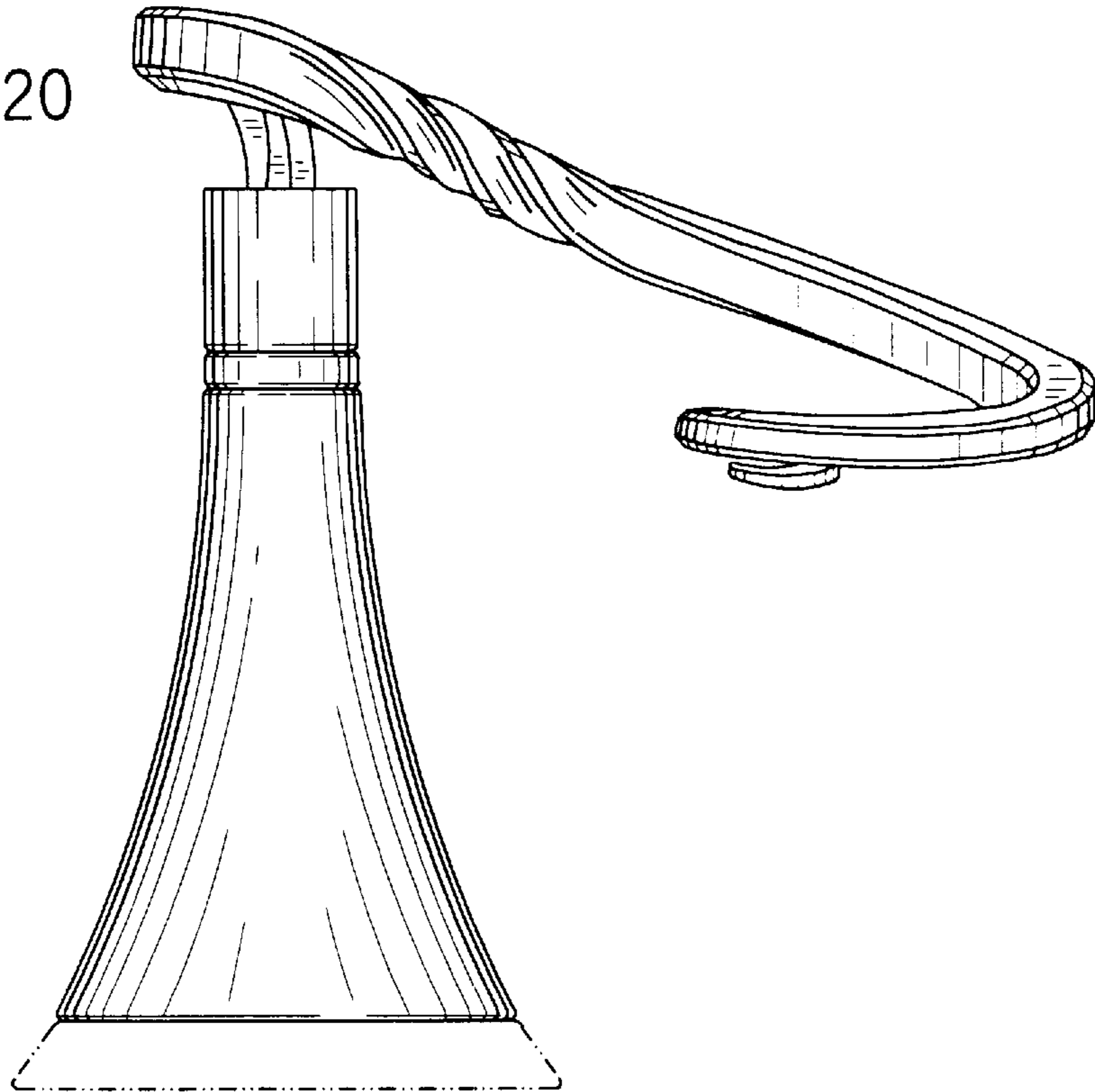

FIG. 21

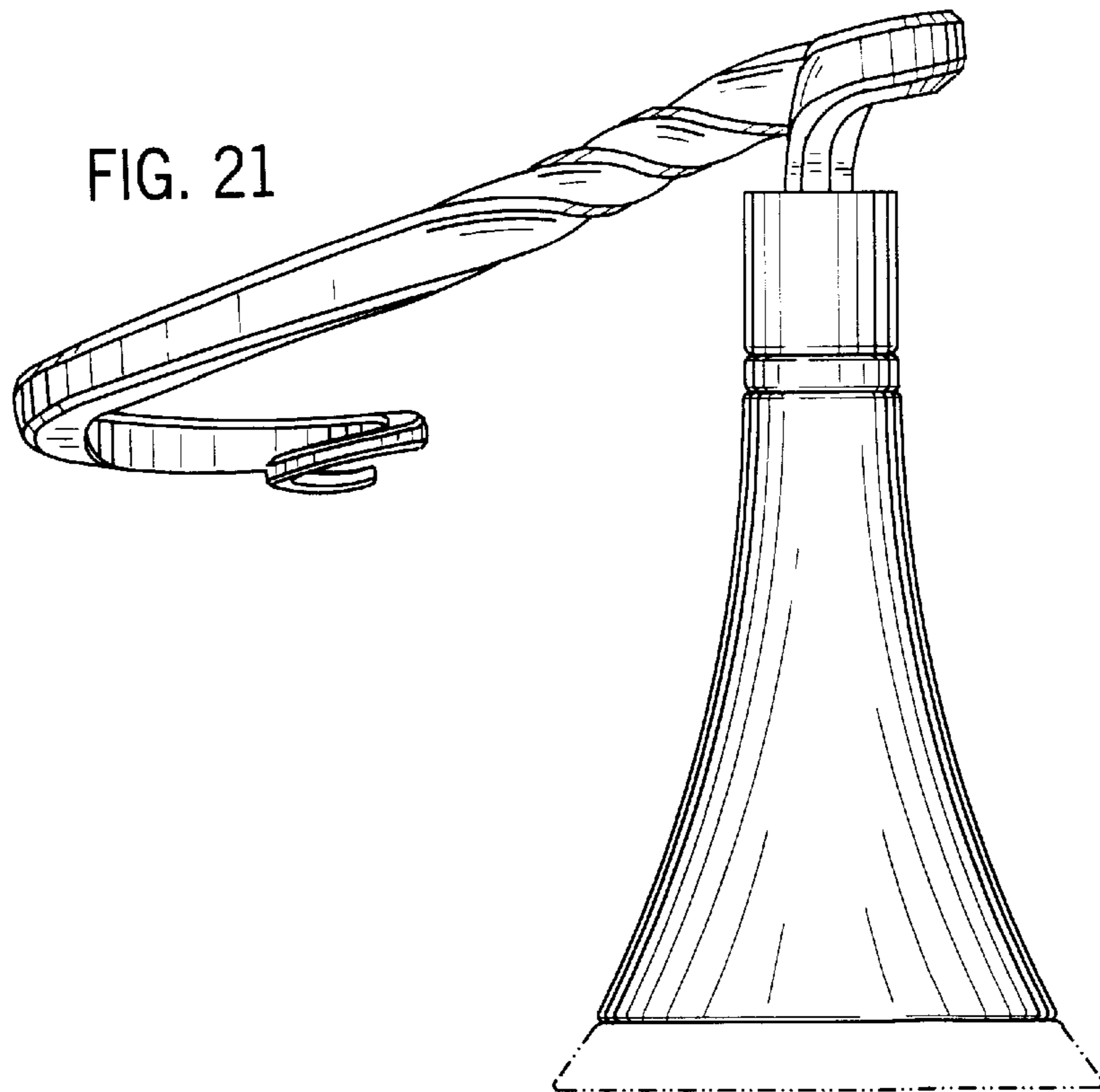

FIG. 22

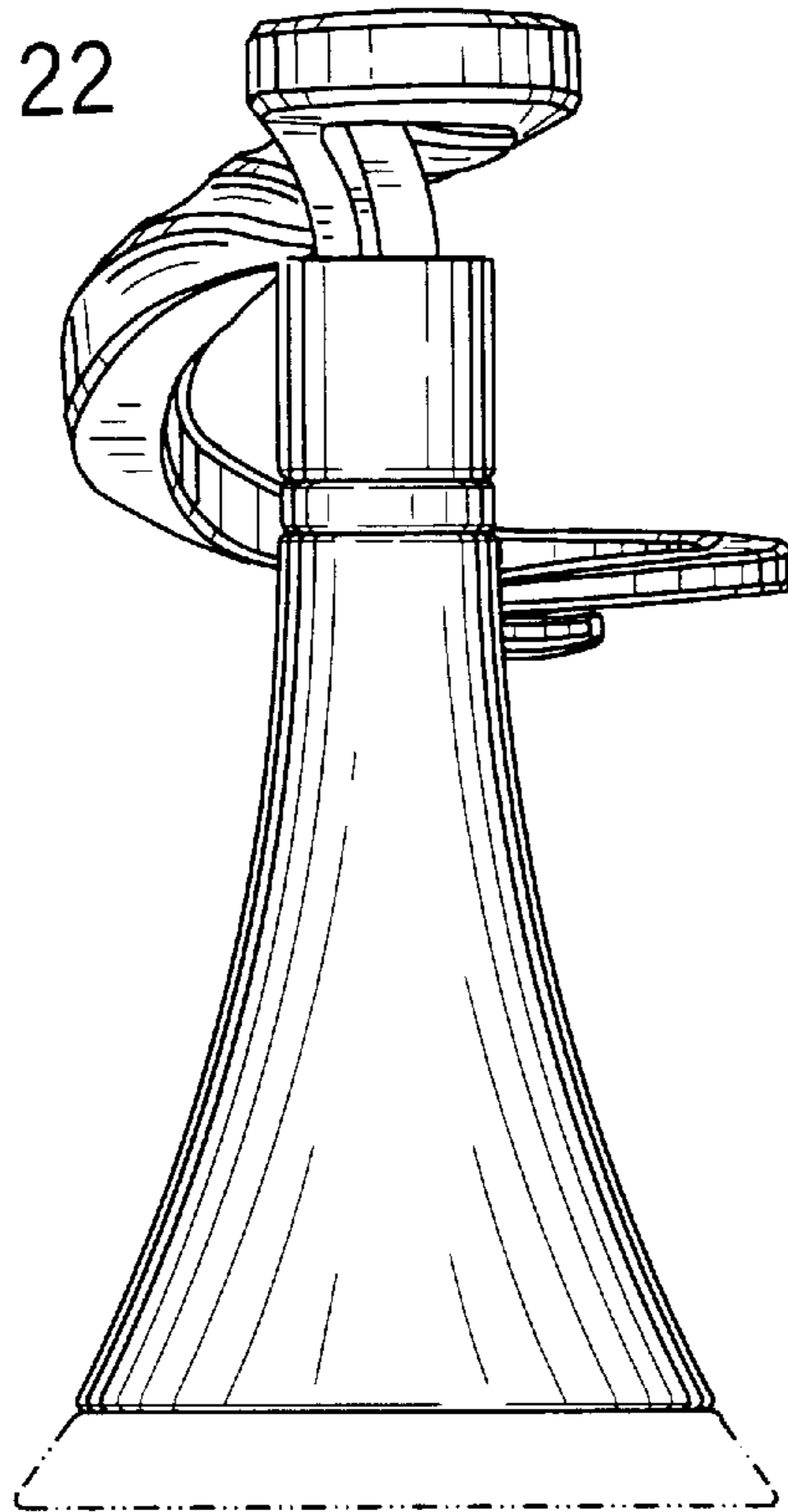

FIG. 23

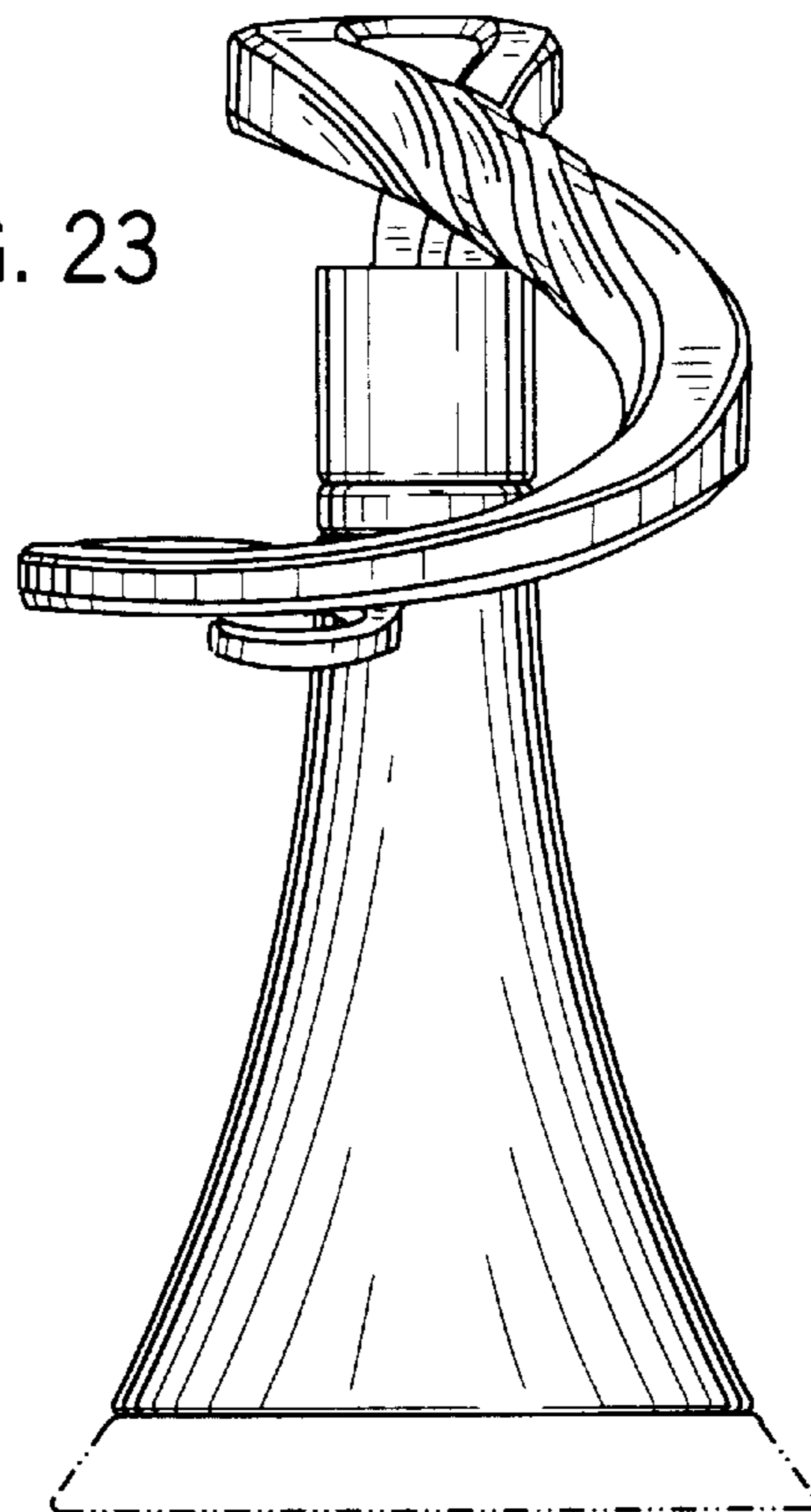

FIG. 24

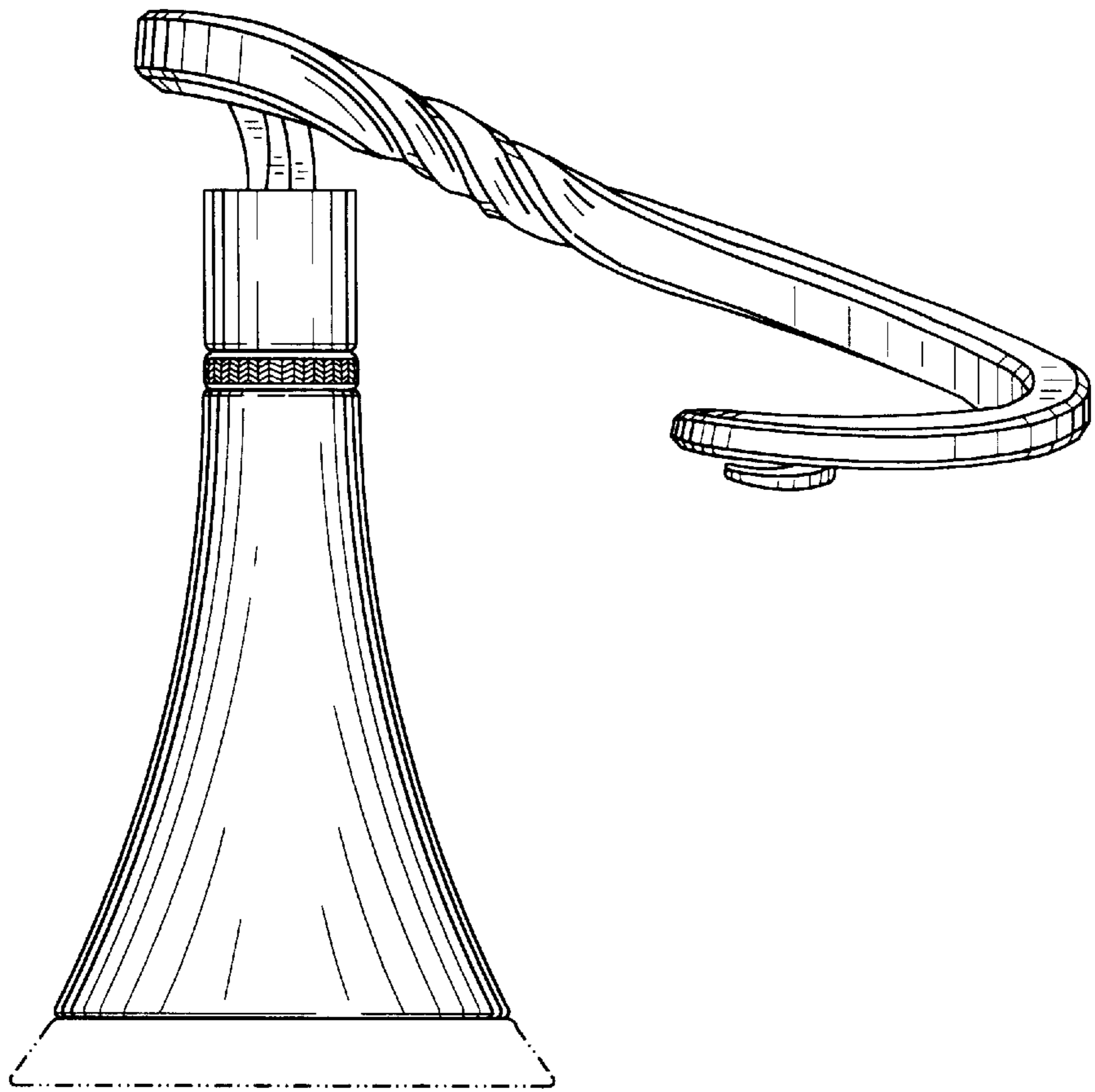

FIG. 25

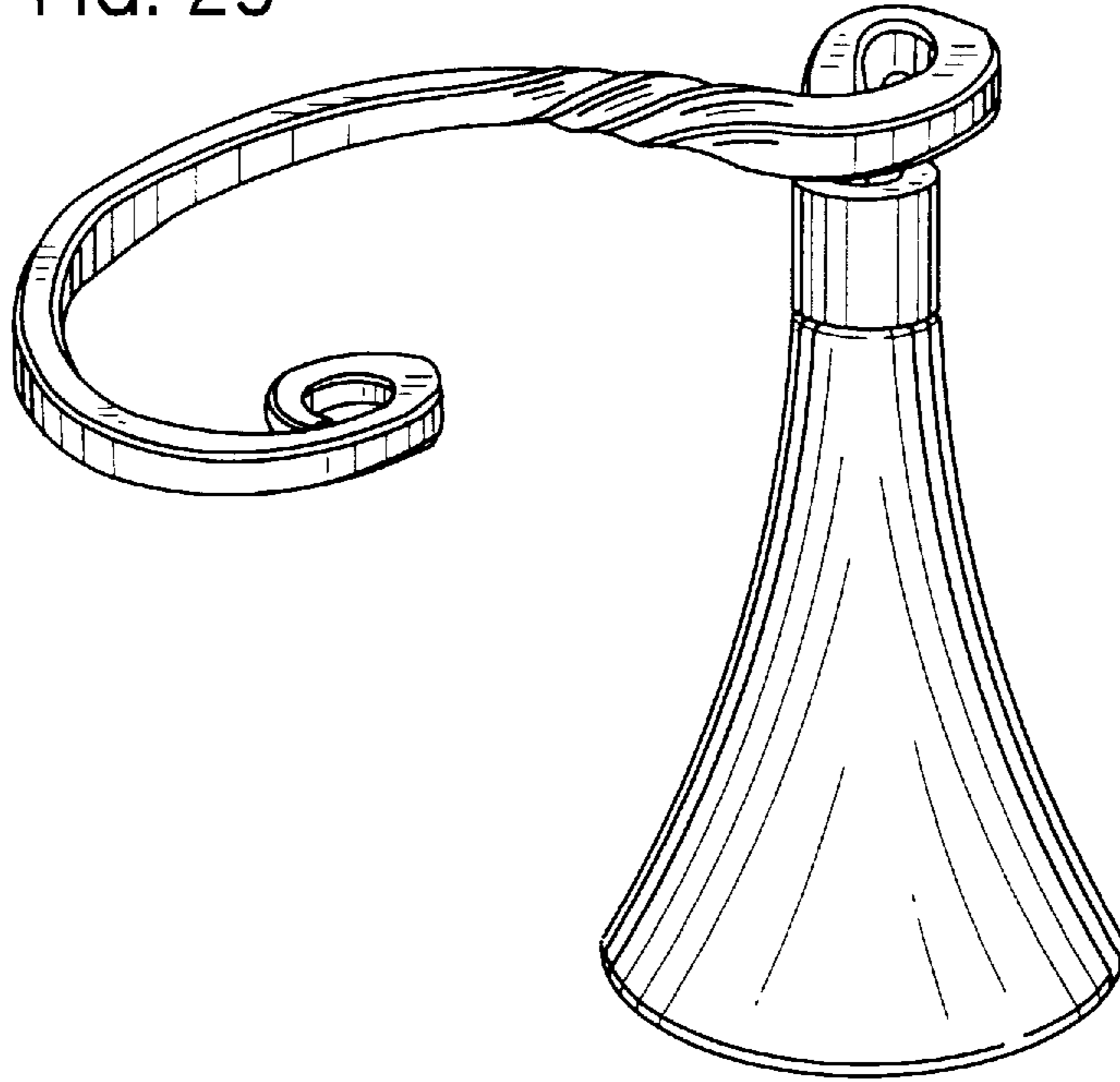
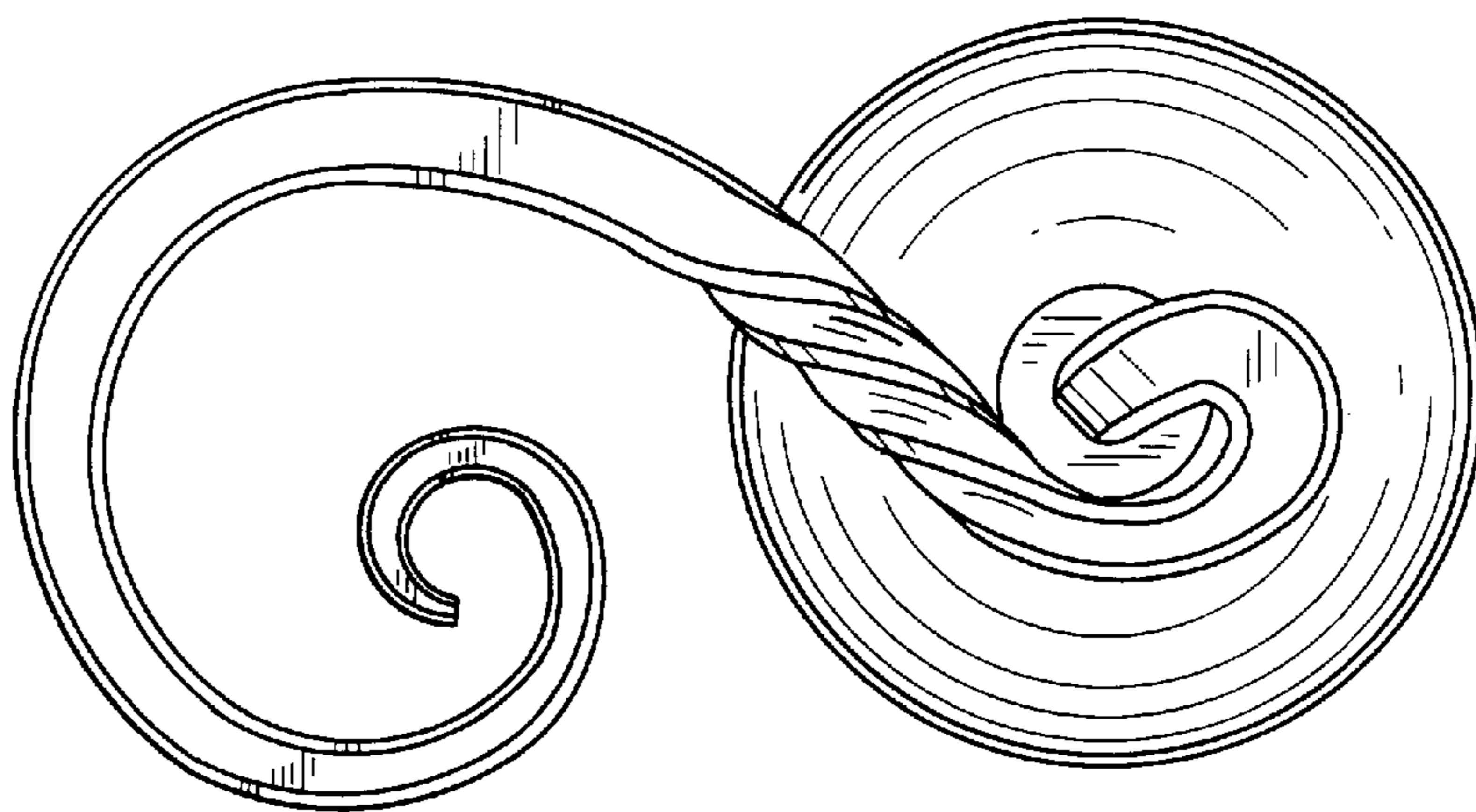

FIG. 26





UNITED STATES PATENT AND TRADEMARK OFFICE  
**CERTIFICATE OF CORRECTION**

PATENT NO. : D398,377  
DATED : September 15, 1998  
INVENTOR(S) : Jill E. Hundley, et al.

It is certified that error appears in the above-identified patent and that said Letters Patent is hereby corrected as shown below:

**DESCRIPTION**

In the Fig. 8 description replace "elevation" with --elevational--.

Delete "Fig. 13 is a top plan view thereof;" after "The dotted line representations of an escutcheon in FIG. 7-11 and 20-24 are for purposes of illustration only, and form no part of the claimed design."

Signed and Sealed this  
Twenty-fifth Day of May, 1999

Attest:



Q. TODD DICKINSON

Attesting Officer

Acting Commissioner of Patents and Trademarks