



US00D398287S

United States Patent [19]
Luminosu

[11] **Patent Number: Des. 398,287**

[45] **Date of Patent: **Sep. 15, 1998**

[54] **CHARGER ADAPTER**

D. 349,096 7/1994 Hyvonen D13/144 X
4,682,139 7/1987 Kuo D13/144 X

[75] Inventor: **Viorel Luminosu**, Plantation, Fla.

[73] Assignee: **Motorola, Inc.**, Schaumburg, Ill.

[**] Term: **14 Years**

Primary Examiner—Susan J. Lucas
Assistant Examiner—Jennifer Rivard
Attorney, Agent, or Firm—m. Mansour Ghomeshi

[21] Appl. No.: **71,782**

[22] Filed: **Jun. 6, 1997**

[57] **CLAIM**

The ornamental design for a charger adapter, as shown and described.

[51] **LOC (6) Cl.** **13-03**

[52] **U.S. Cl.** **D13/144; D13/107**

[58] **Field of Search** D13/144, 107,
D13/108; D27/139, 142; 439/668, 669;
363/146; 337/216, 186

DESCRIPTION

FIG. 1 is a front elevational view of a charger adapter showing my new design;
FIG. 2 is a rear elevational view thereof;
FIG. 3 is a top plan view thereof;
FIG. 4 is a bottom plan view thereof;
FIG. 5 is a left elevational view thereof;
FIG. 6 is a right elevational view thereof; and,
FIG. 7 is a front, bottom, rear isometric view thereof.

[56] **References Cited**

U.S. PATENT DOCUMENTS

D. 303,954 10/1989 Michels et al. D14/155
D. 348,250 6/1994 Shababy D13/144

1 Claim, 4 Drawing Sheets

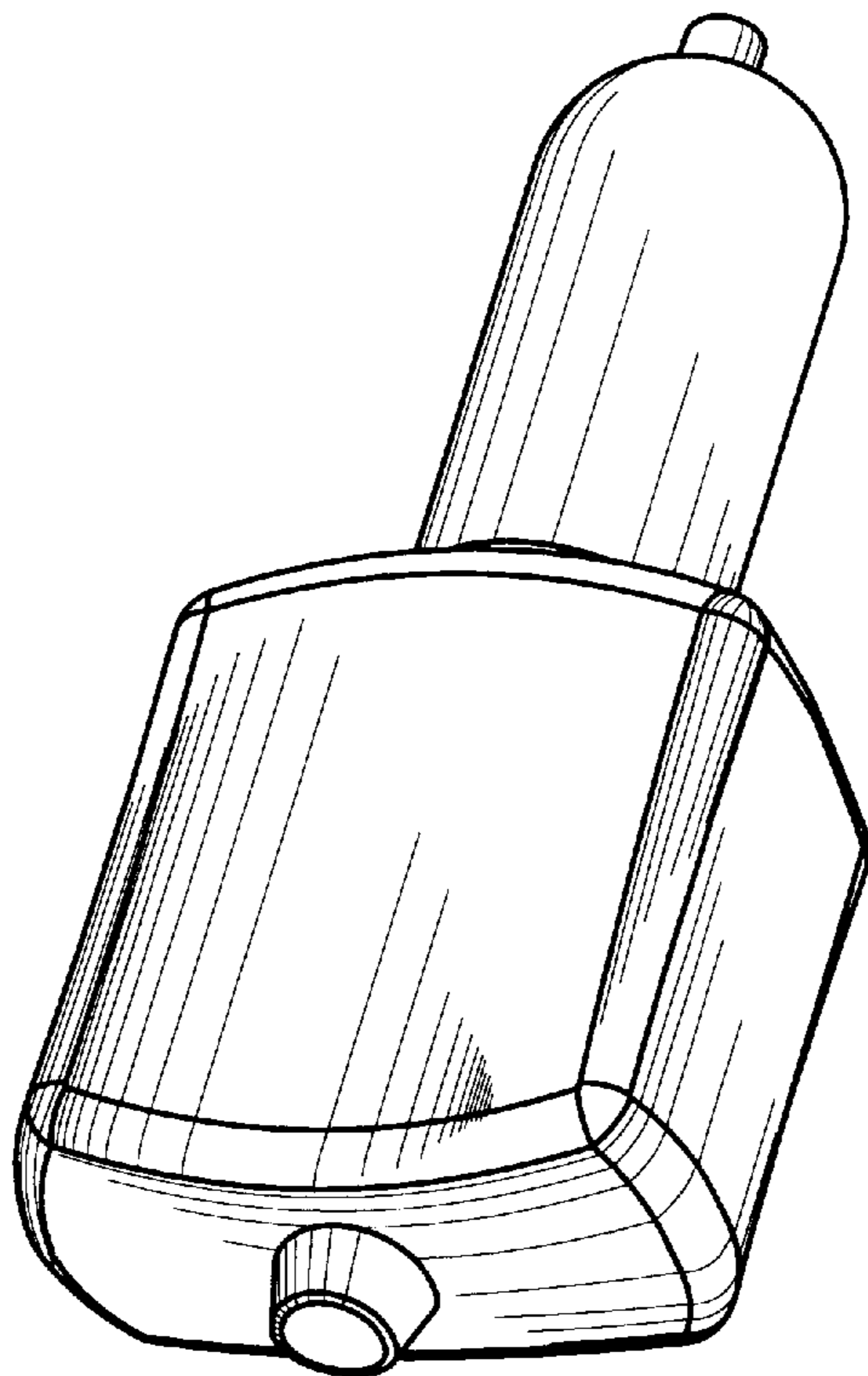

FIG. 2

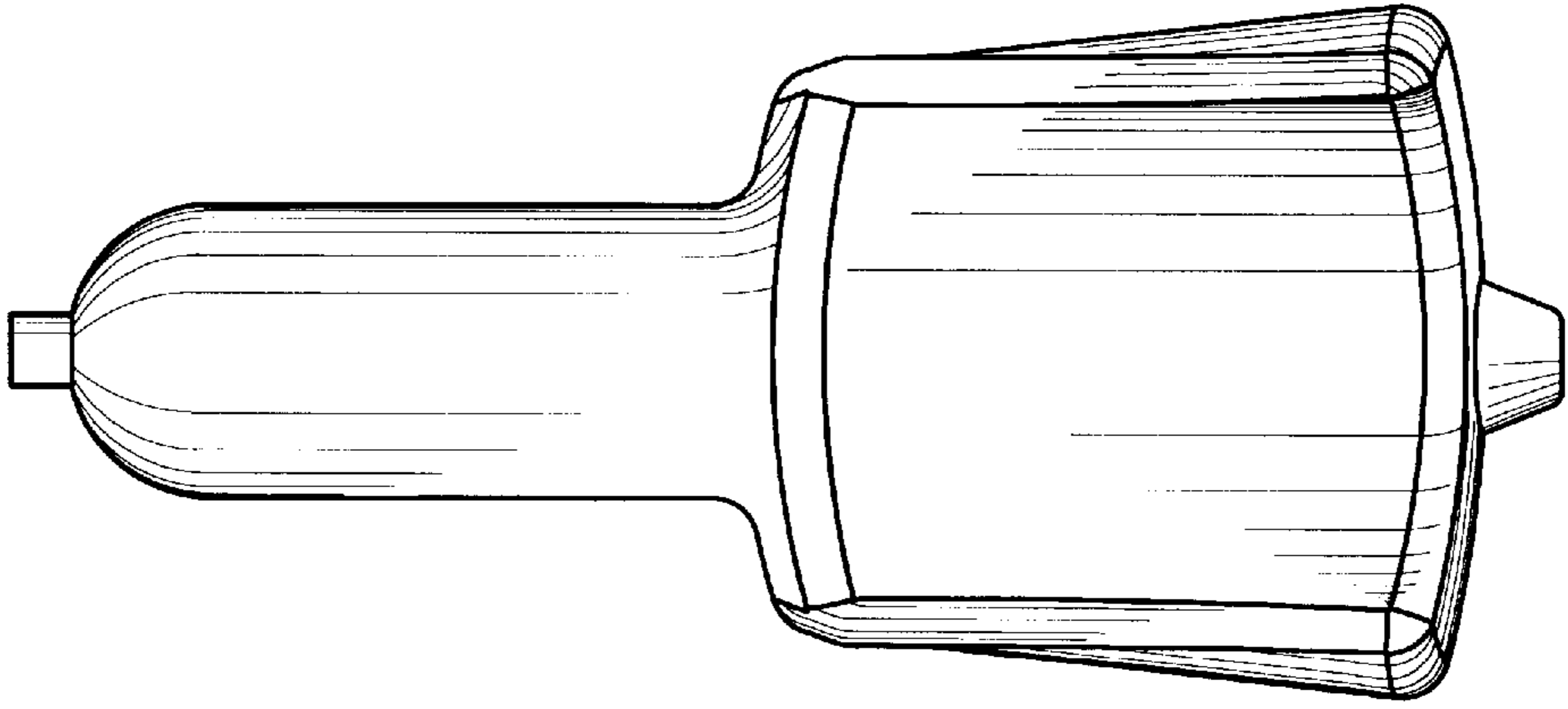

FIG. 1

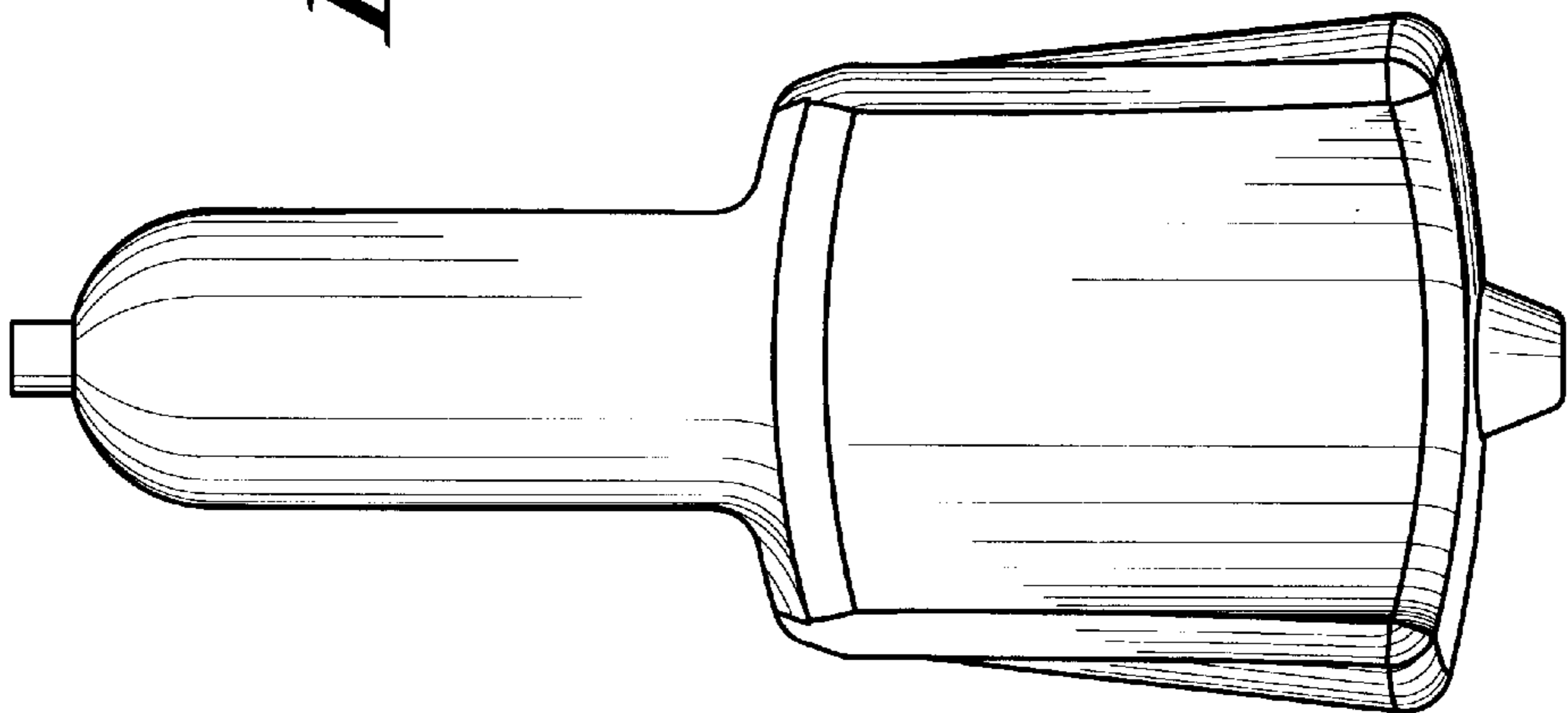

FIG. 4

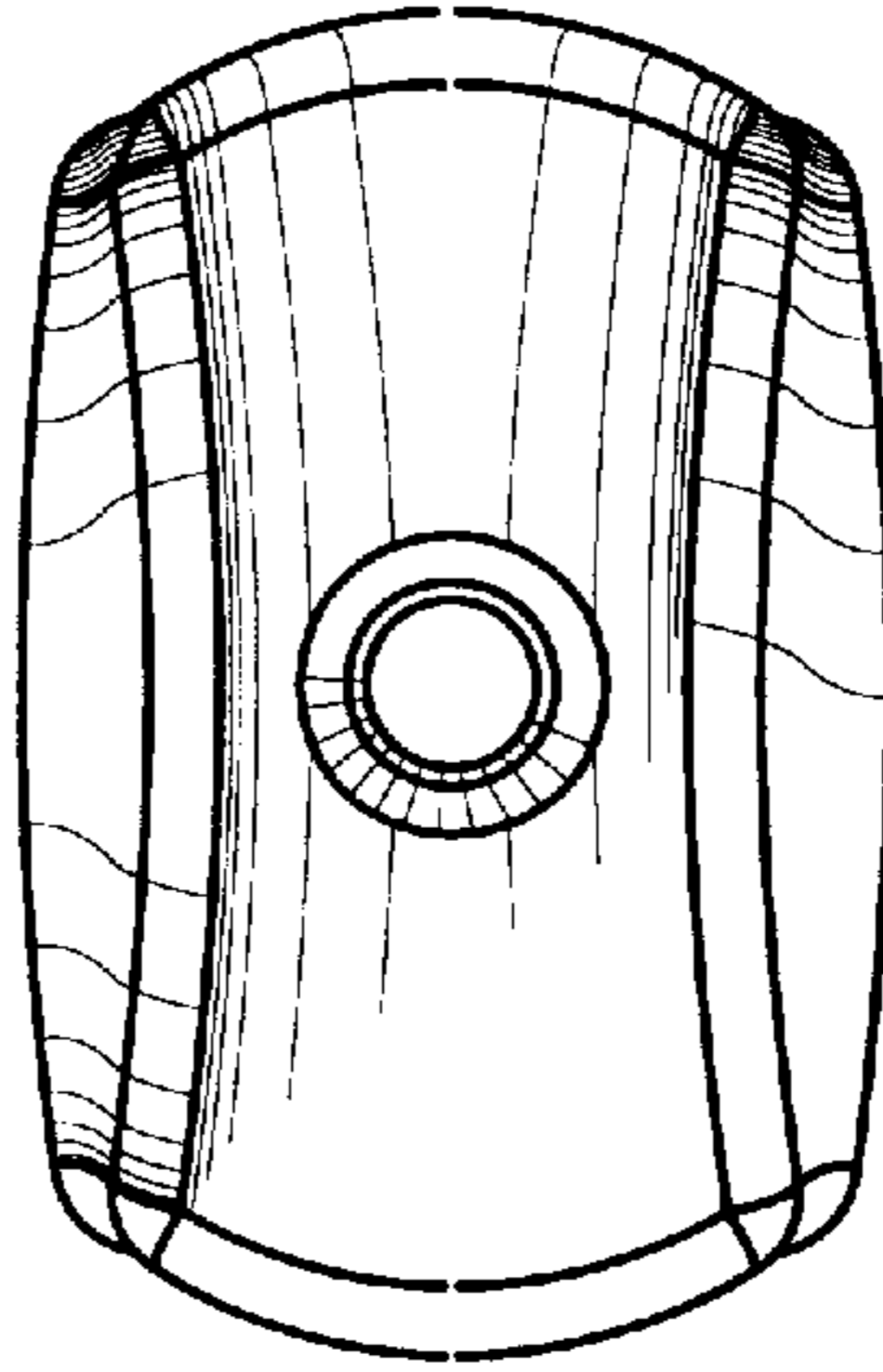

FIG. 3

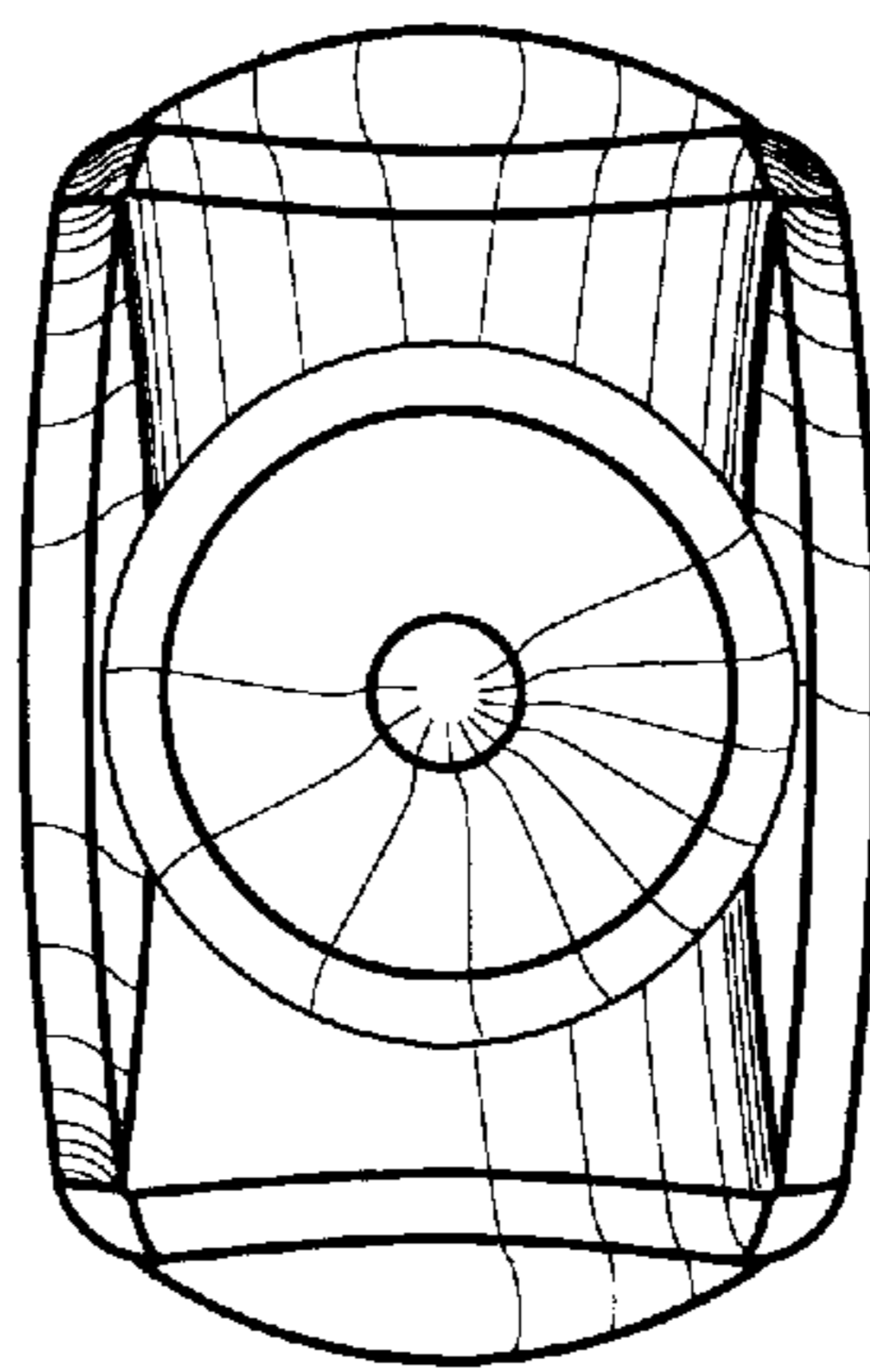

FIG. 6

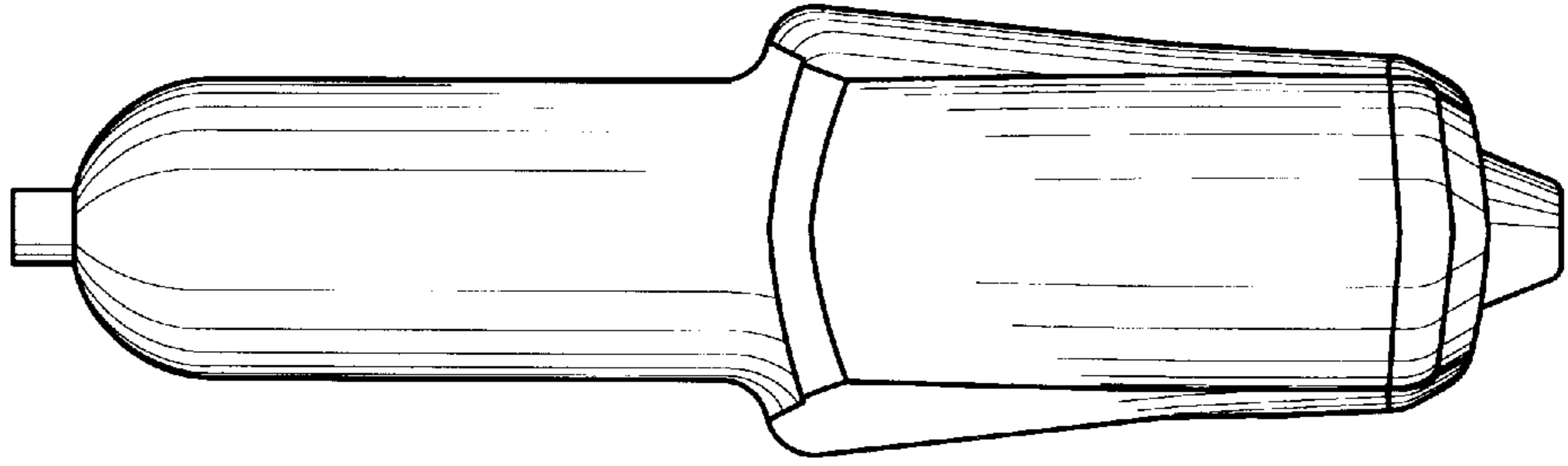

FIG. 5

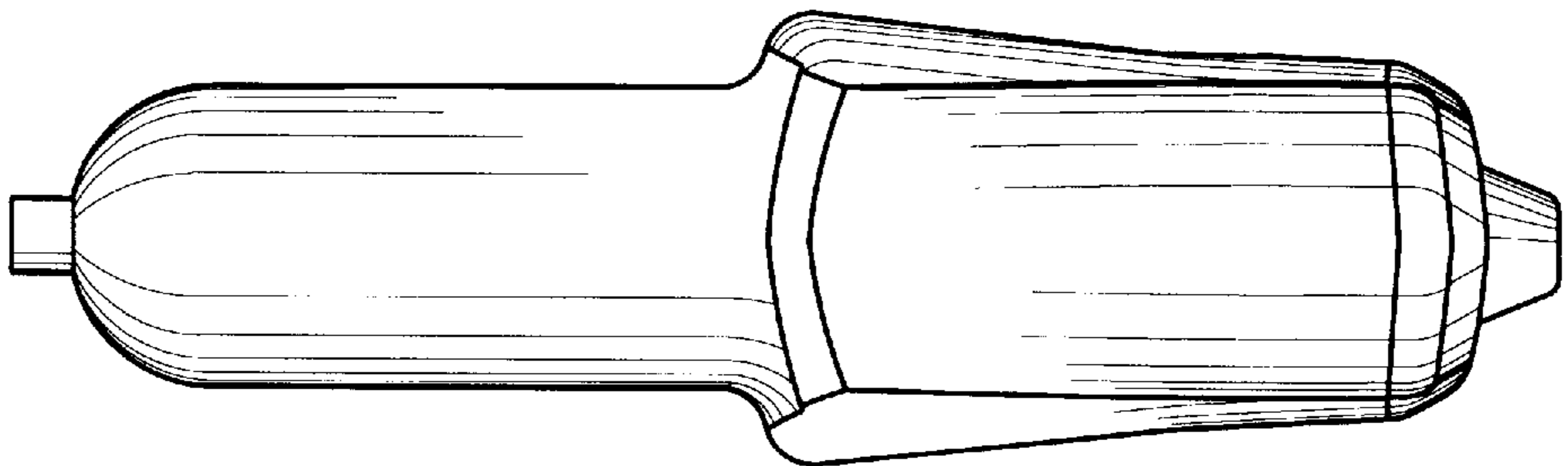

FIG. 7

