



US00D398282S

United States Patent [19]

[11] **Patent Number: Des. 398,282**

Dirks

[45] **Date of Patent: **Sep. 15, 1998**

[54] **PICKUP BED COVER**

[57] **CLAIM**

[76] Inventor: **Jay D. Dirks**, 2205 E. Mountain Ct.,
Athol, Id. 83801

The ornamental design for a pickup bed cover, as shown and described.

[**] Term: **14 Years**

DESCRIPTION

[21] Appl. No.: **73,771**

FIG. 1 is a perspective view of a pickup bed cover showing a first embodiment of the present design;

[22] Filed: **Jul. 17, 1997**

FIG. 2 is a top plan view thereof;

[51] **LOC (6) Cl. 12-06**

[52] **U.S. Cl. D12/221**

[58] **Field of Search D12/221, 401;**
296/99.1, 100, 98; 160/231.1, 213; 280/423.1

FIG. 3 is a left side elevation view thereof, the opposite, right side being a mirror image thereof;

FIG. 4 is a front end view thereof as seen from the left in FIG. 3;

FIG. 5 is a rear end view as seen from the right in FIG. 3;

FIG. 6 is a perspective view of a second embodiment of the present design;

FIG. 7 is a top plan view thereof;

FIG. 8 is a left side view thereof, the right side being a mirror image thereof;

FIG. 9 is a front elevation view thereof as seen from the left in FIG. 8; and,

FIG. 10 is a rear end view thereof as seen from the right in FIG. 8.

The bottom side surfaces of the first and second embodiments are plain and unornamented and do not constitute part of the claimed design.

[56] **References Cited**

U.S. PATENT DOCUMENTS

4,909,561	3/1990	Lovass	296/100
5,011,214	4/1991	Friesen et al.	296/100
5,056,856	10/1991	Pederson	280/423.1 X
5,344,159	9/1994	Powell	296/100
5,427,428	6/1995	Ericson et al.	296/98
5,564,773	10/1996	Lapsley et al.	296/100

Primary Examiner—Melody N. Brown
Attorney, Agent, or Firm—Wells, St. John, Roberts, Gregory & Matkin P.S.

1 Claim, 6 Drawing Sheets

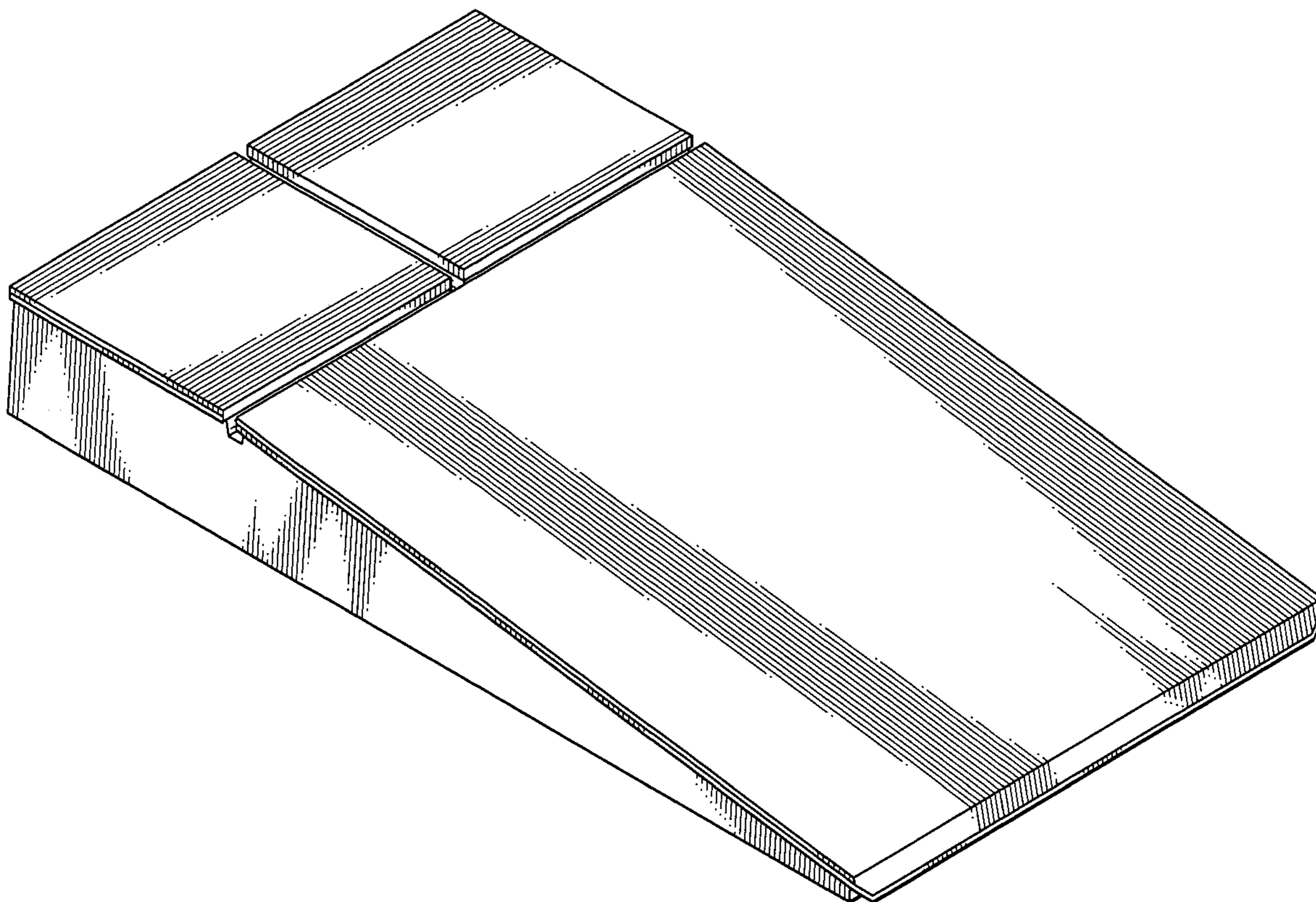

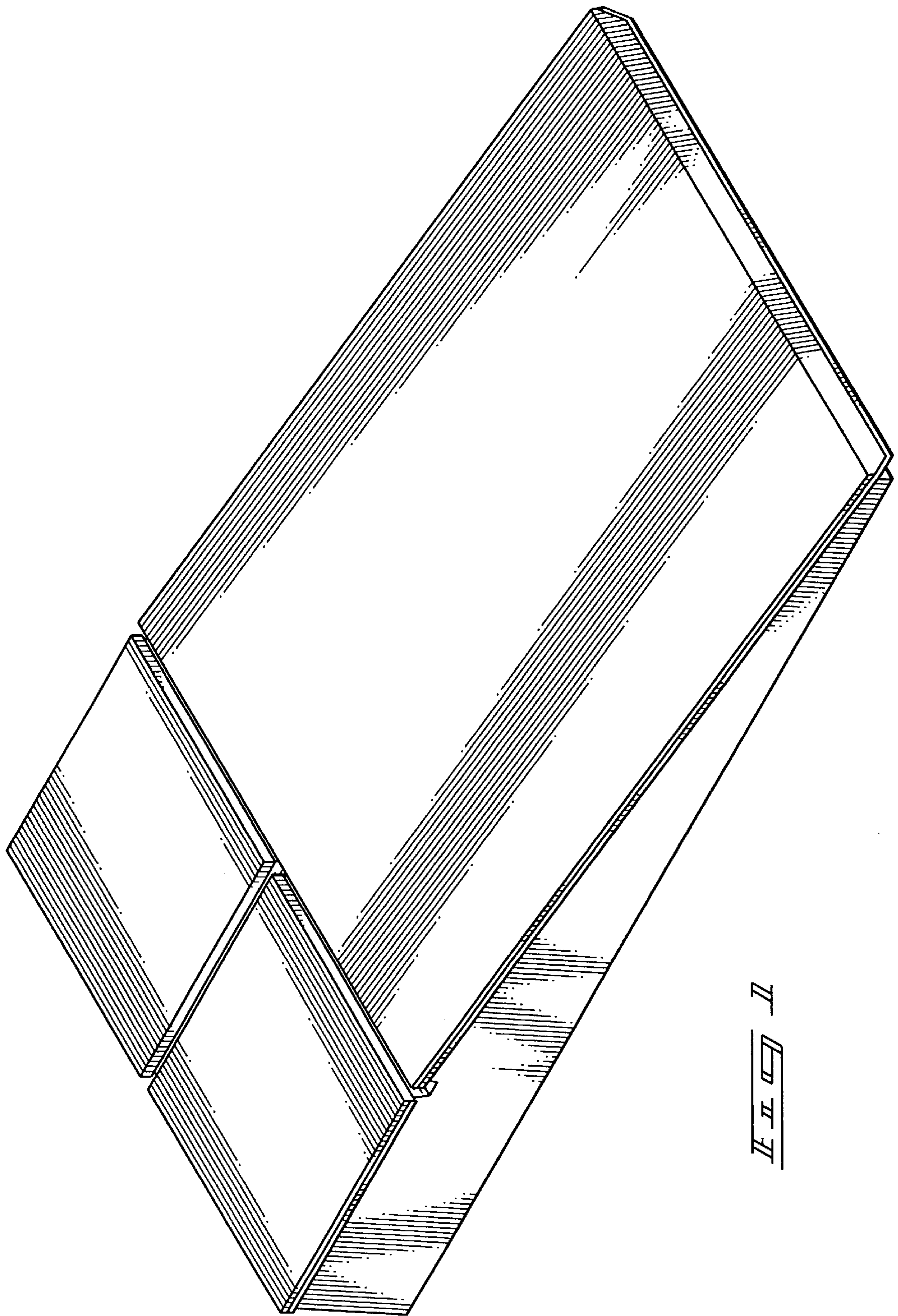

FIG. 1

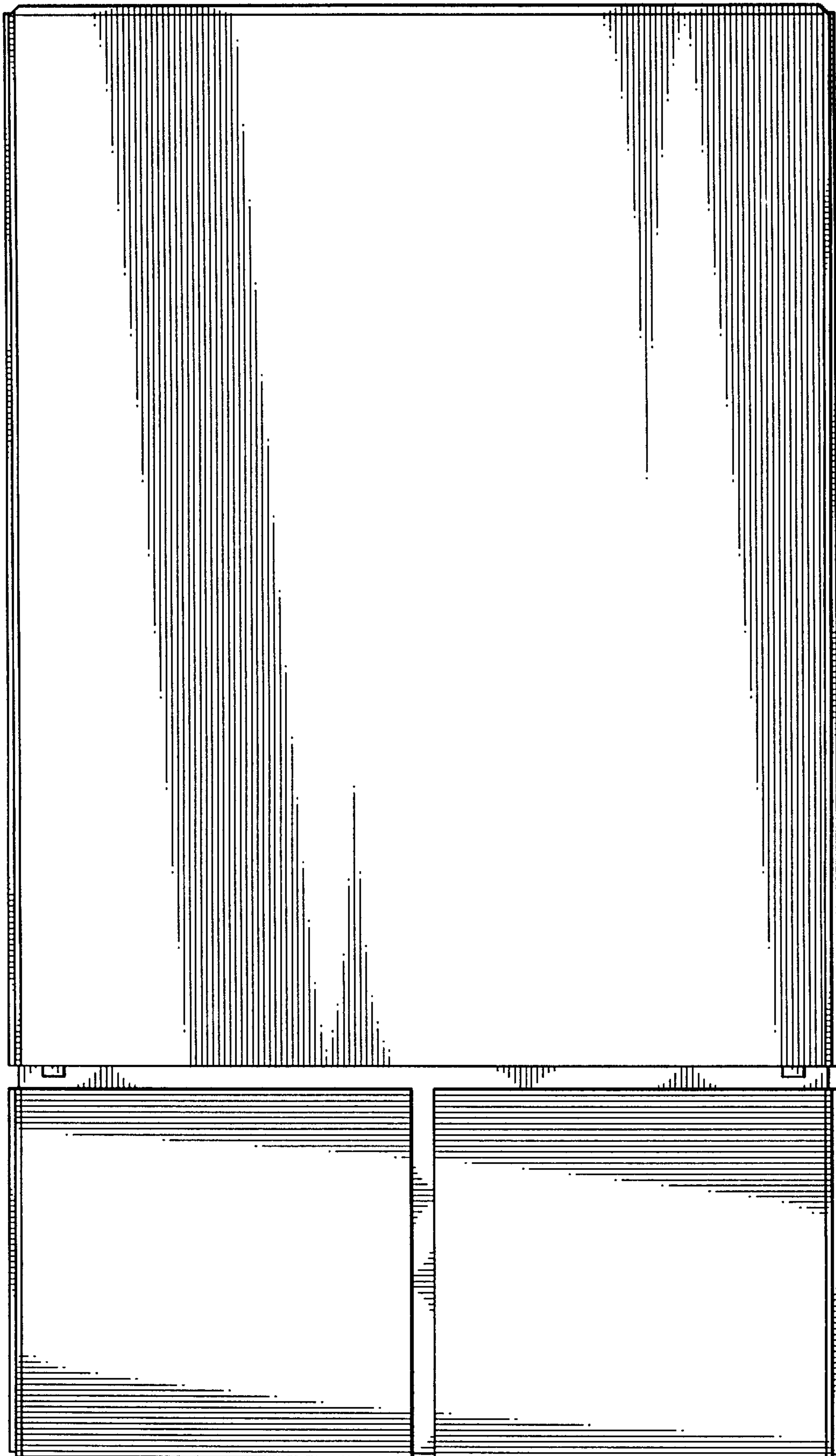
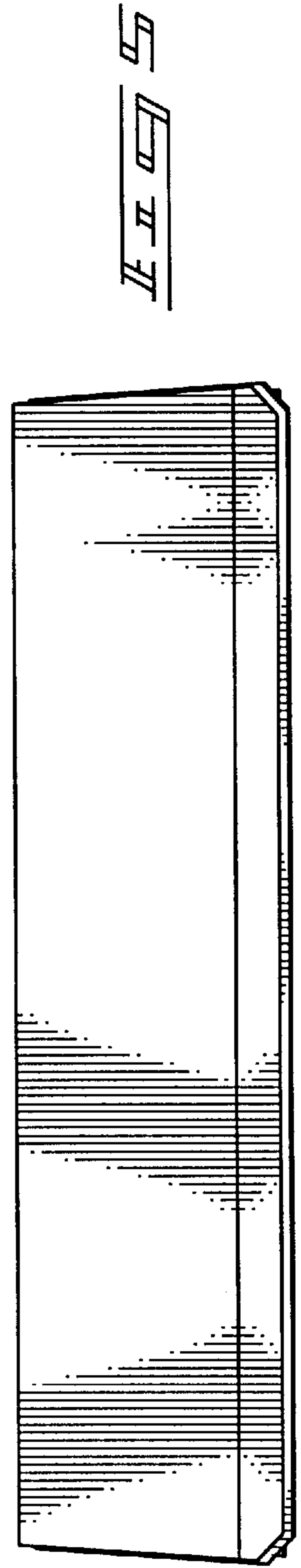
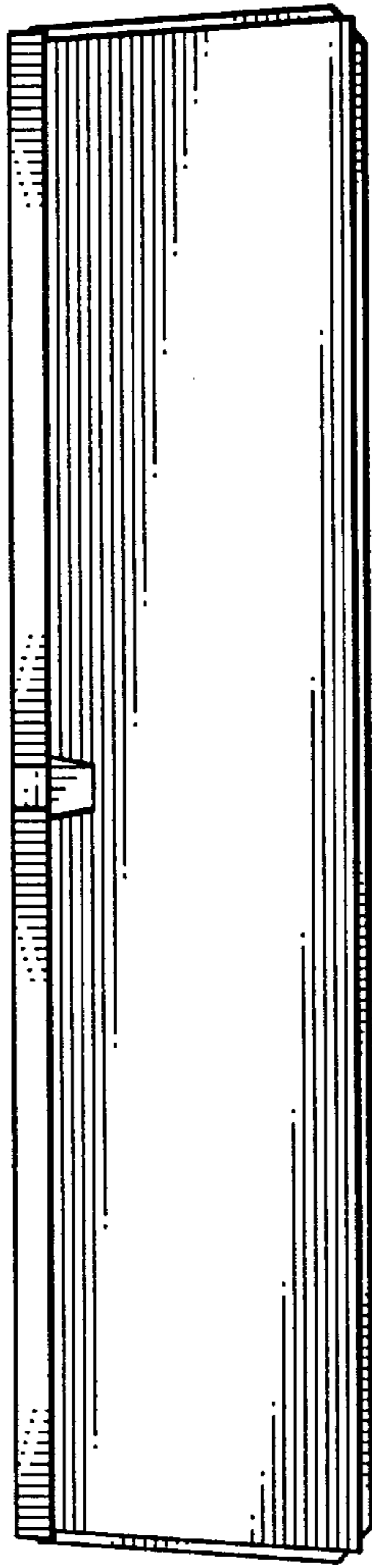
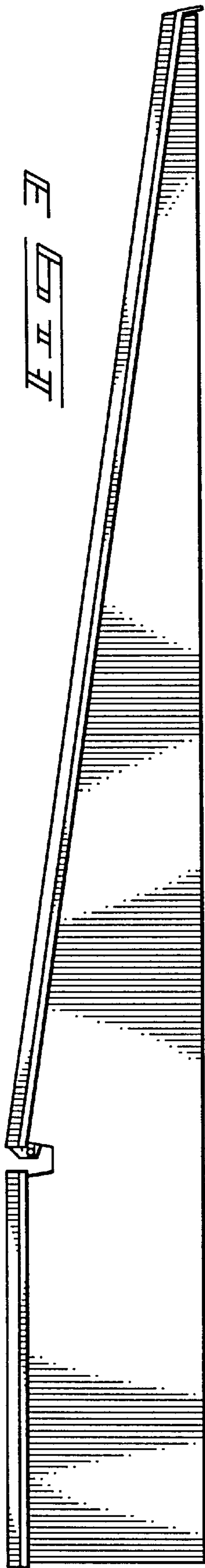

FIG. 2



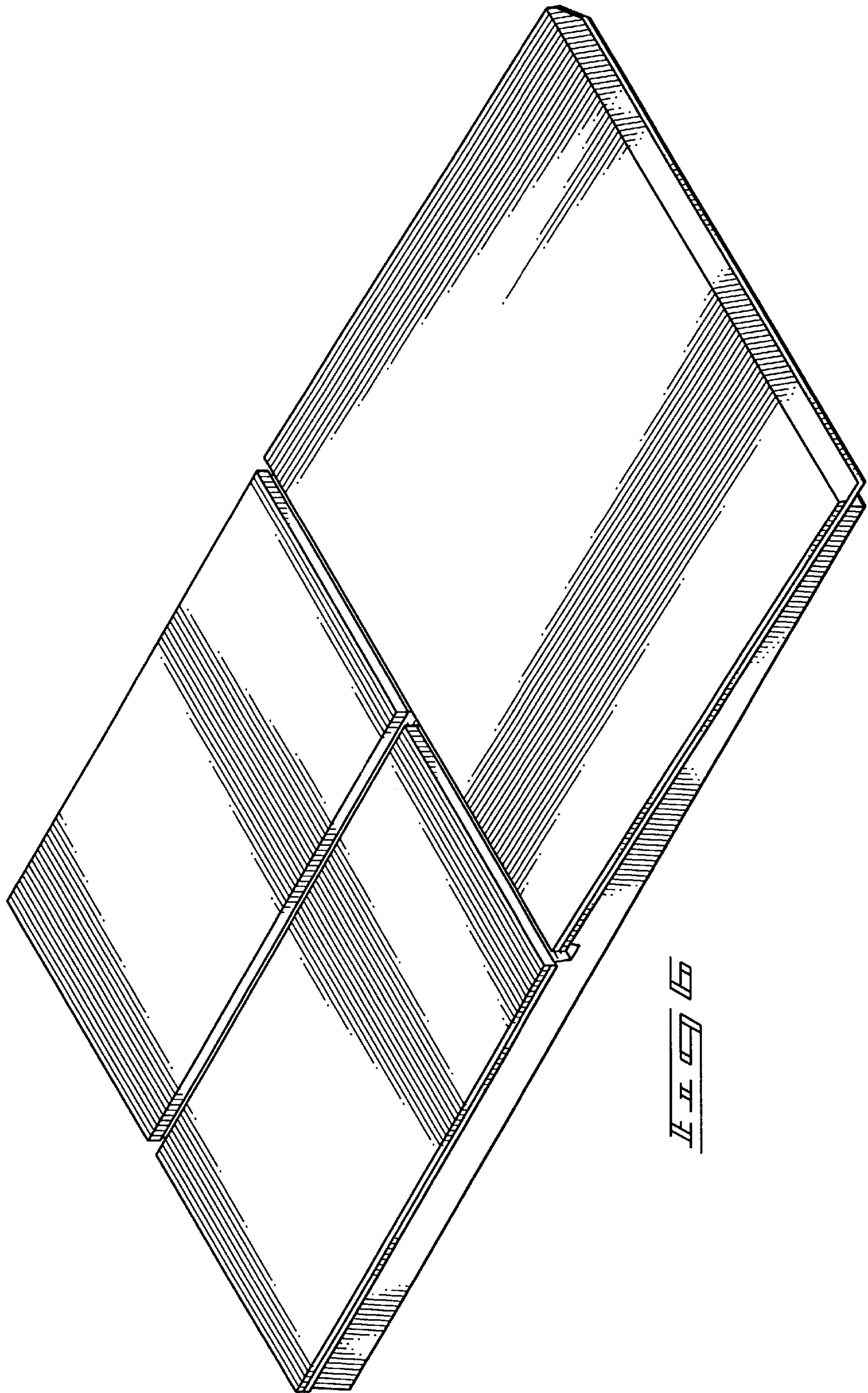

FIG. 4

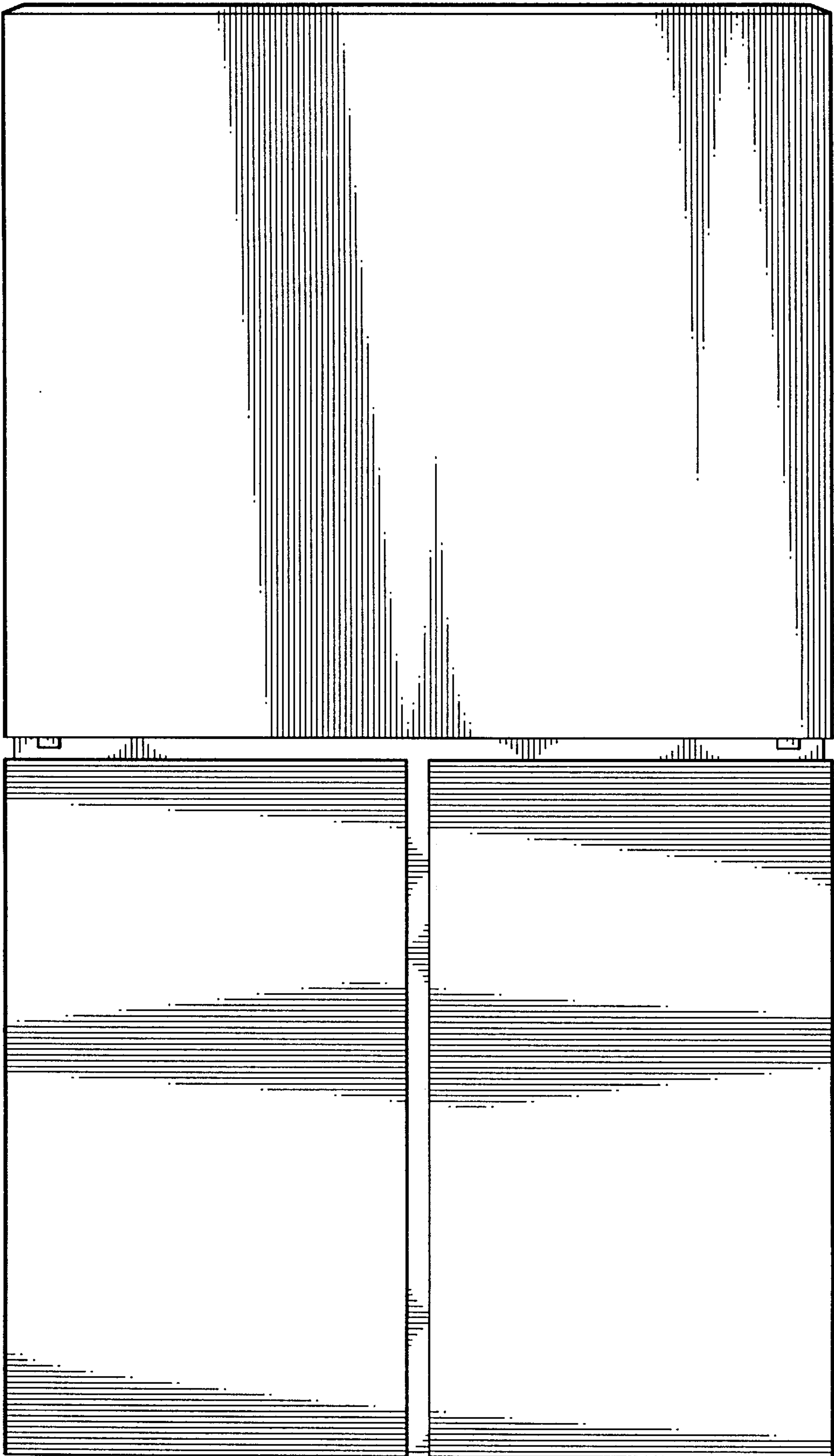

Fig. 5

