



US00D398245S

United States Patent [19]

Knutson et al.

[11] **Patent Number: Des. 398,245**

[45] **Date of Patent: **Sep. 15, 1998**

[54] **ALARM CLOCK**

[75] Inventors: **Robert A. Knutson**, Eagan; **Johannes N. Gaston**; **Douglas J. VanOrnum**, both of Minnetonka, all of Minn.

[73] Assignee: **Soleil Sun Alarm Company LLC**, Apple Valley, Minn.

[**] Term: **14 Years**

[21] Appl. No.: **74,935**

[22] Filed: **Aug. 13, 1997**

[51] **LOC (6) Cl.** **10-01**

[52] **U.S. Cl.** **D10/28**

[58] **Field of Search** D10/1-40, 122-132; 368/276-277, 285, 316-317

[56] **References Cited**

U.S. PATENT DOCUMENTS

D. 323,467	1/1992	Takashima	D10/28
D. 347,182	5/1994	Wada	D10/28
D. 347,185	5/1994	Shimamura	D10/28
D. 354,236	1/1995	Sugano	D10/28
D. 378,497	3/1997	Shimamura	D10/28

Primary Examiner—Nelson C. Holtje

Attorney, Agent, or Firm—Kinney & Lange, P.A.

[57] **CLAIM**

The ornamental design for an alarm clock, as shown and described.

DESCRIPTION

FIG. 1 is a perspective view of a first embodiment; FIG. 2 is a front elevational view of the first embodiment; FIG. 3 is a rear elevational view of the first embodiment; FIG. 4 is a right side view of the first embodiment; FIG. 5 is a bottom plan view of the first embodiment; FIG. 6 is a top plan view of the first embodiment; FIG. 7 is a perspective view of a second embodiment; FIG. 8 is a front elevational view of the second embodiment; FIG. 9 is a rear elevational view of the second embodiment; FIG. 10 is a right side view of the second embodiment; FIG. 11 is a bottom plan view of the second embodiment; and,

FIG. 12 is a top plan view of the second embodiment. The left side view of the first embodiment is a mirror image of the right side view shown in FIG. 4 and the left side view of the second embodiment is a mirror image of the right side view shown in FIG. 10.

The broken line showings of a dial face are for illustrative purposes only and form no part of the claimed design.

1 Claim, 6 Drawing Sheets

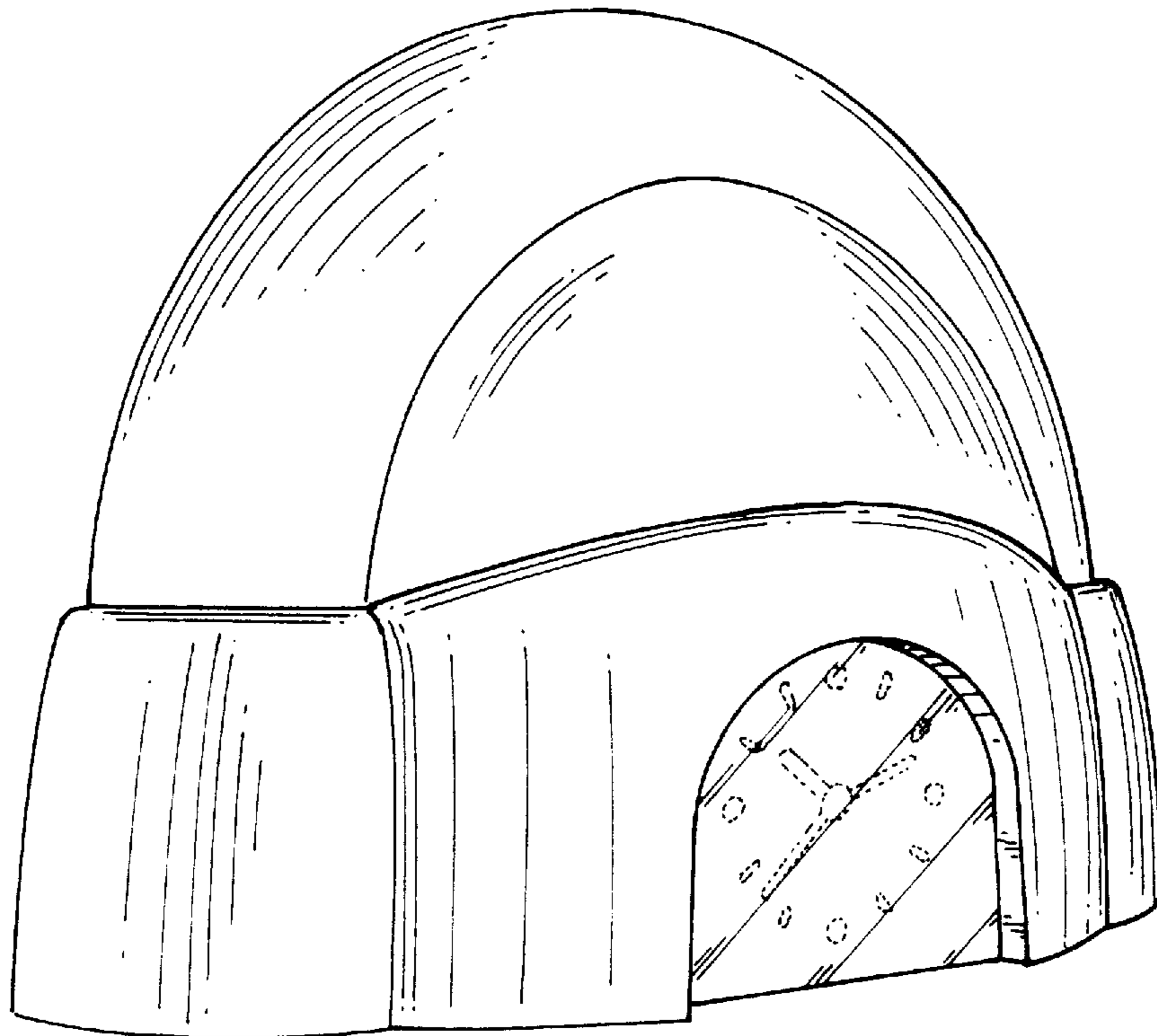

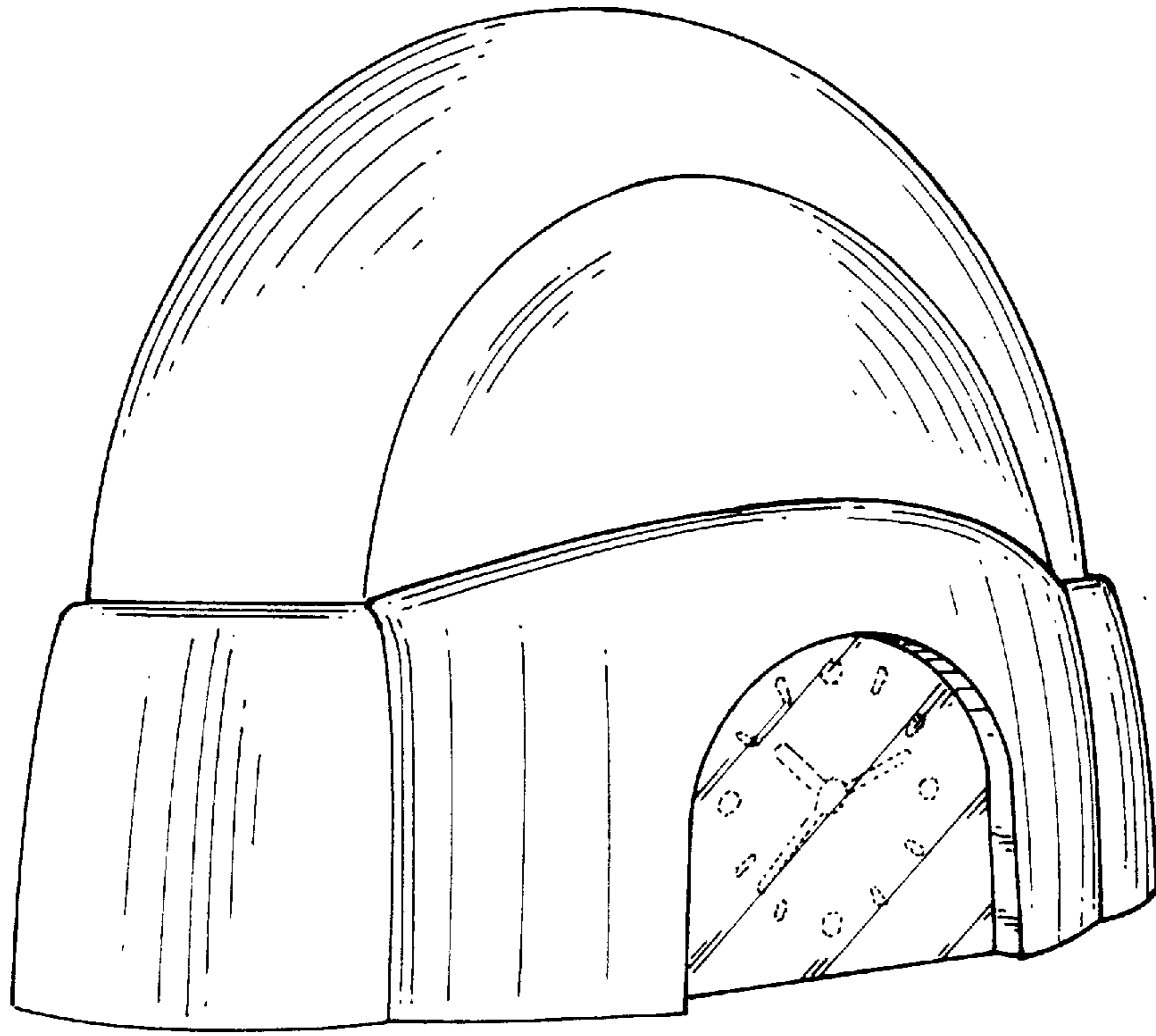

Fig. 1

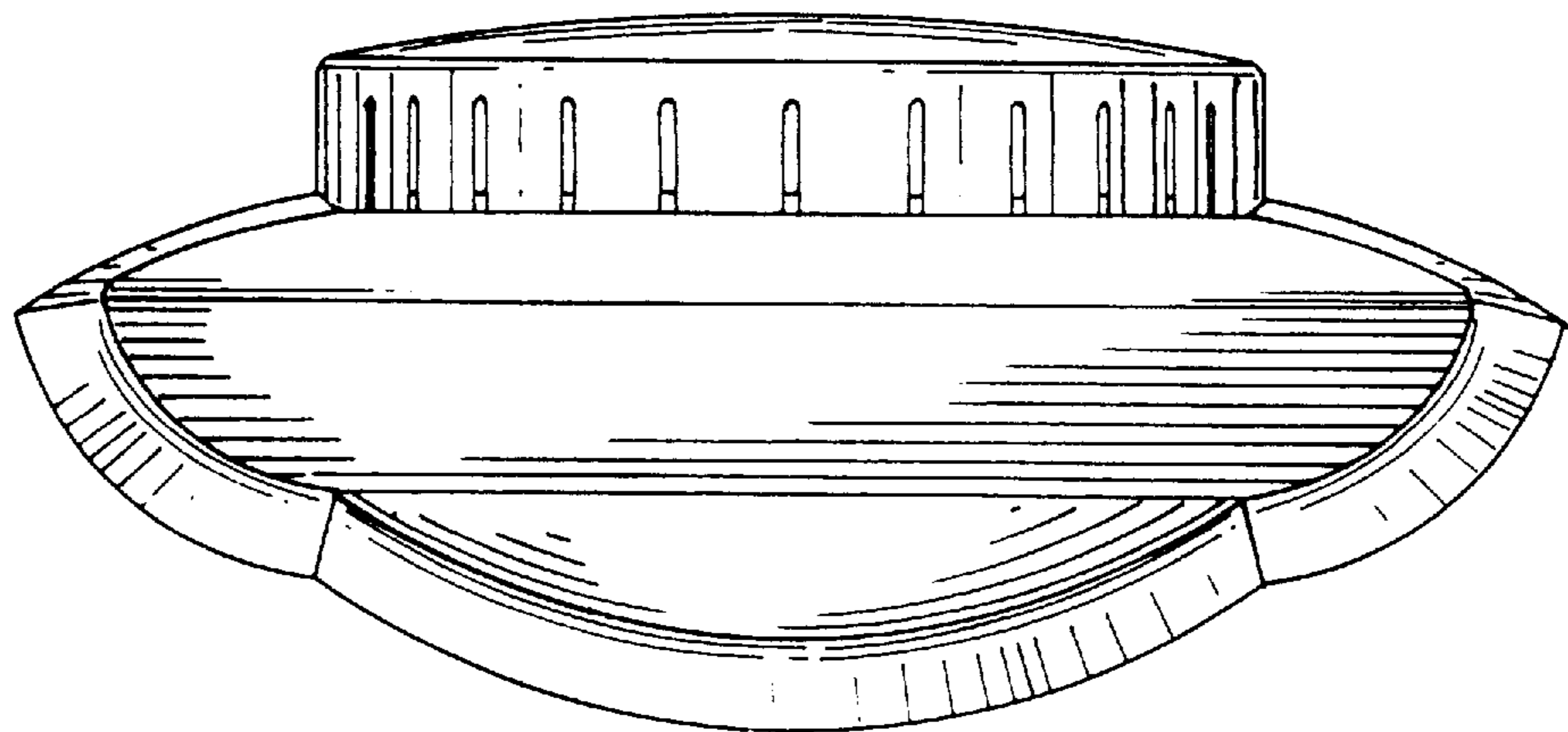

Fig. 6

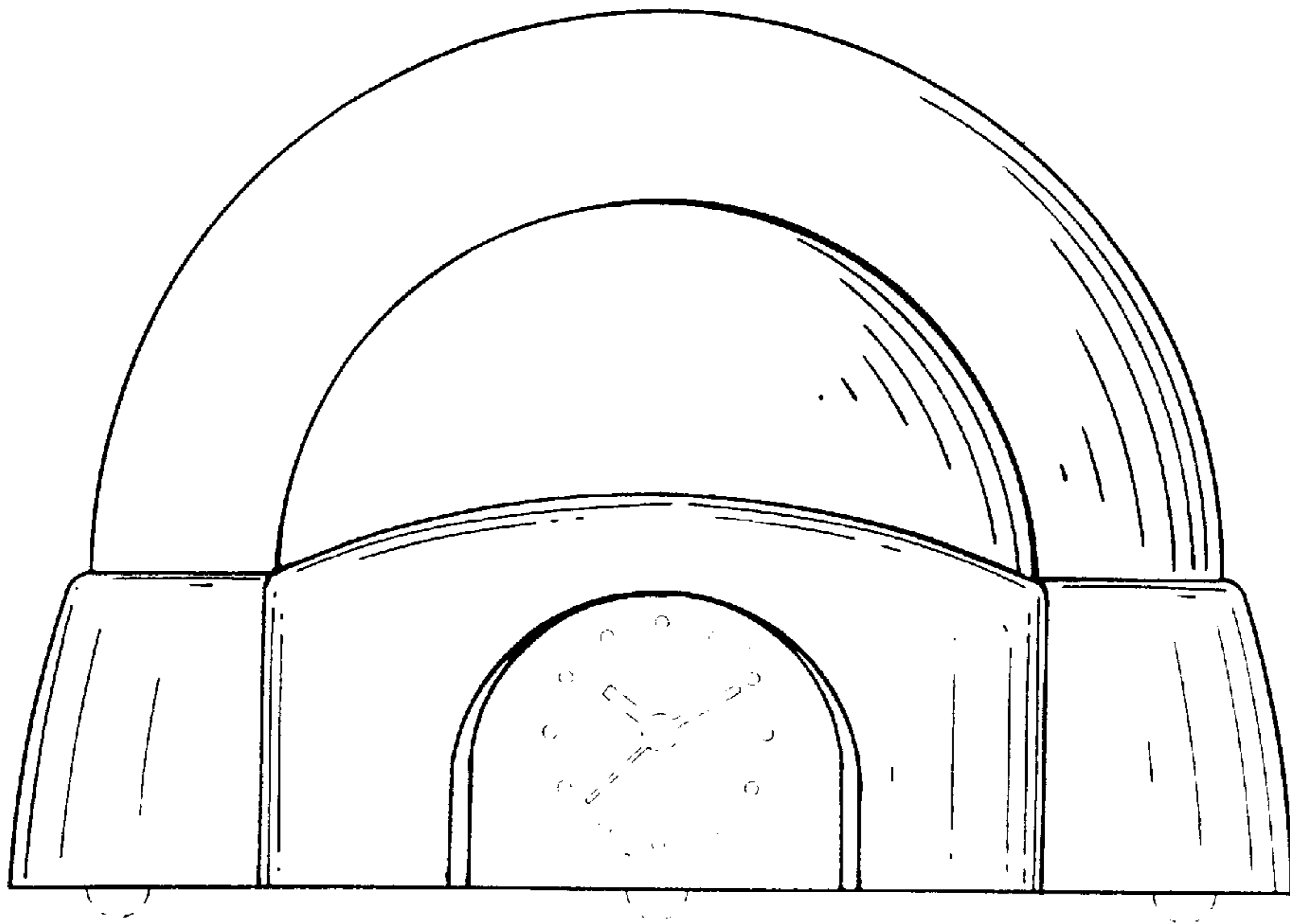

Fig. 2

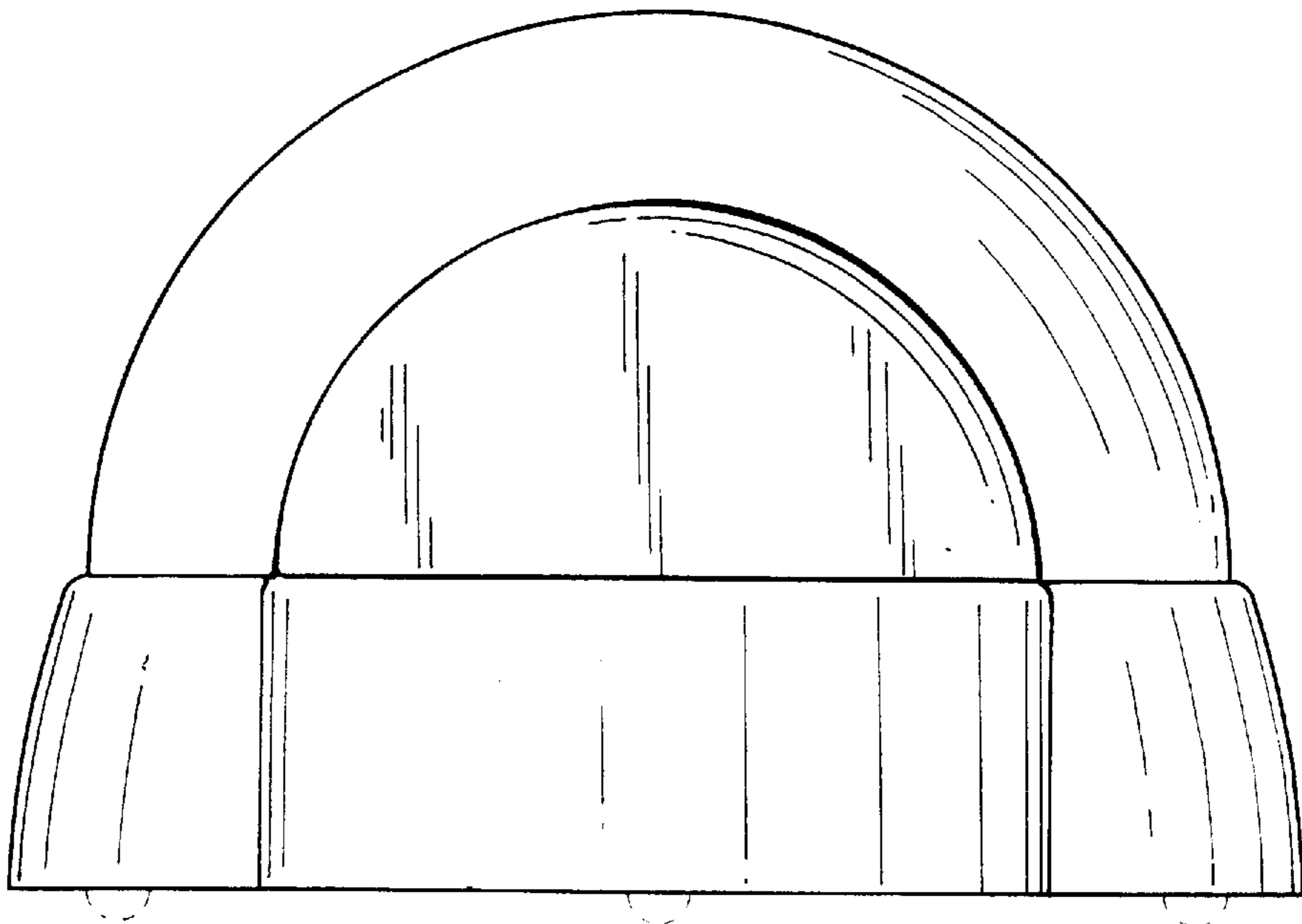

Fig. 3

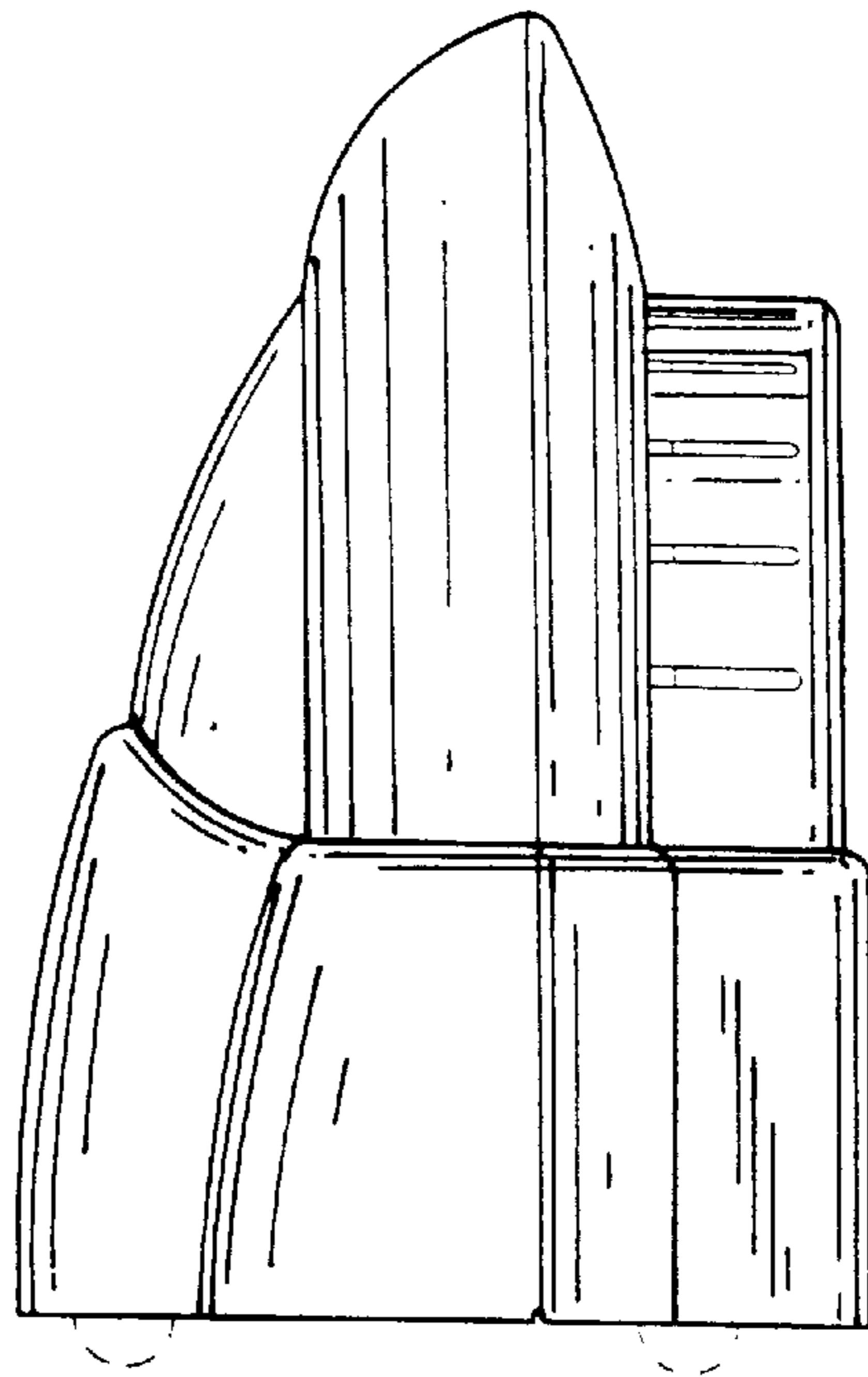

Fig. 4

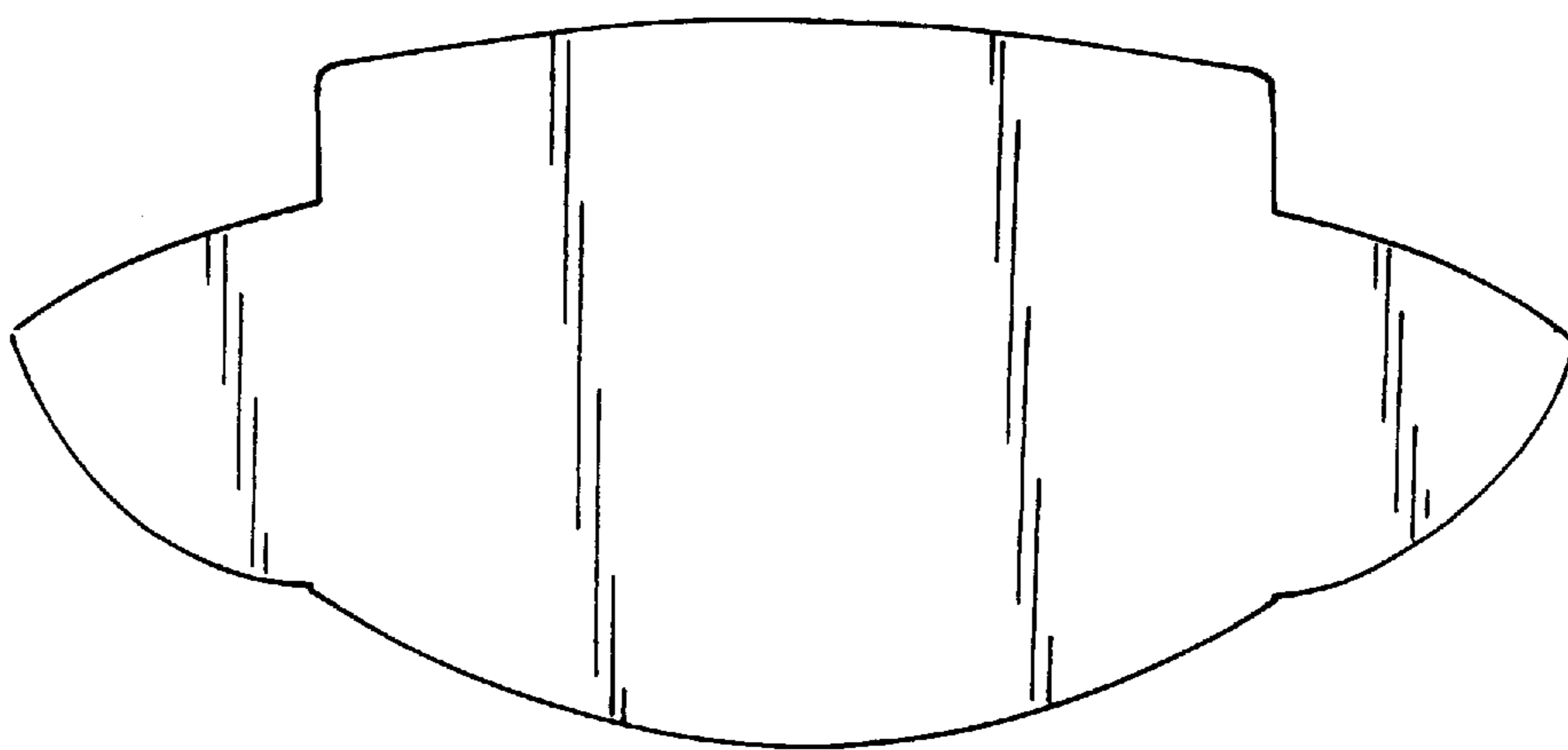

Fig. 5

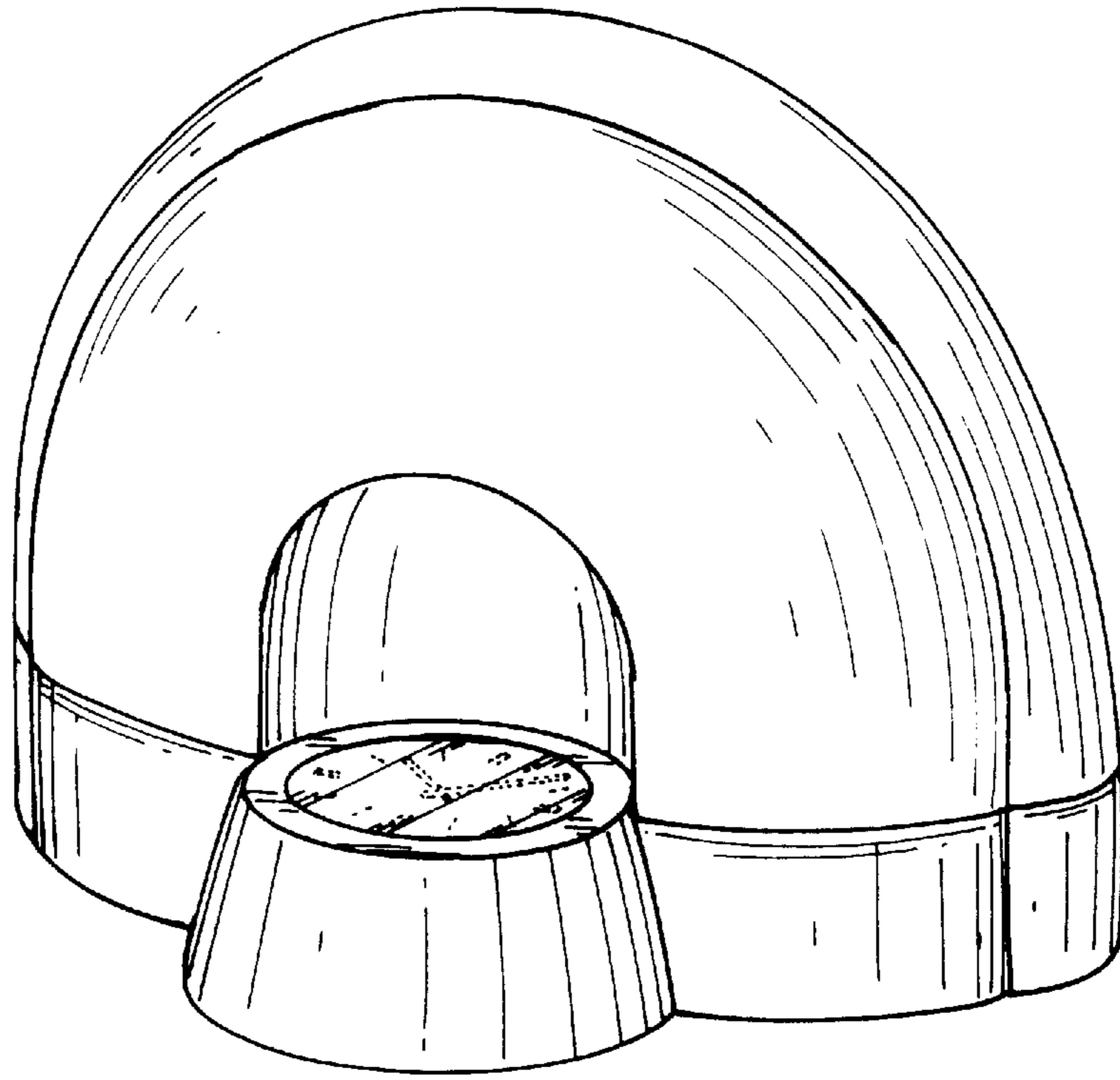

Fig. 7

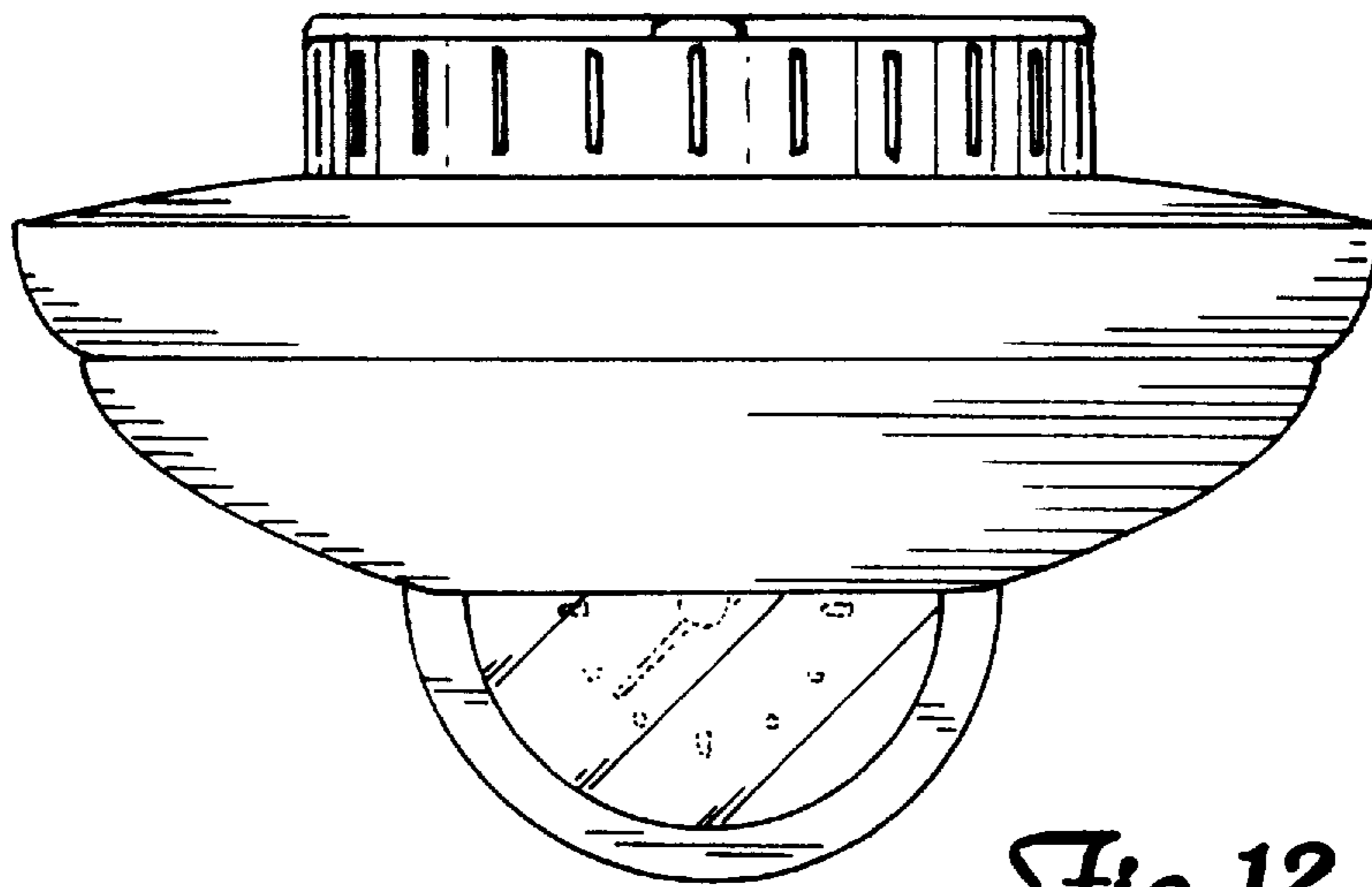

Fig. 12

Fig. 8

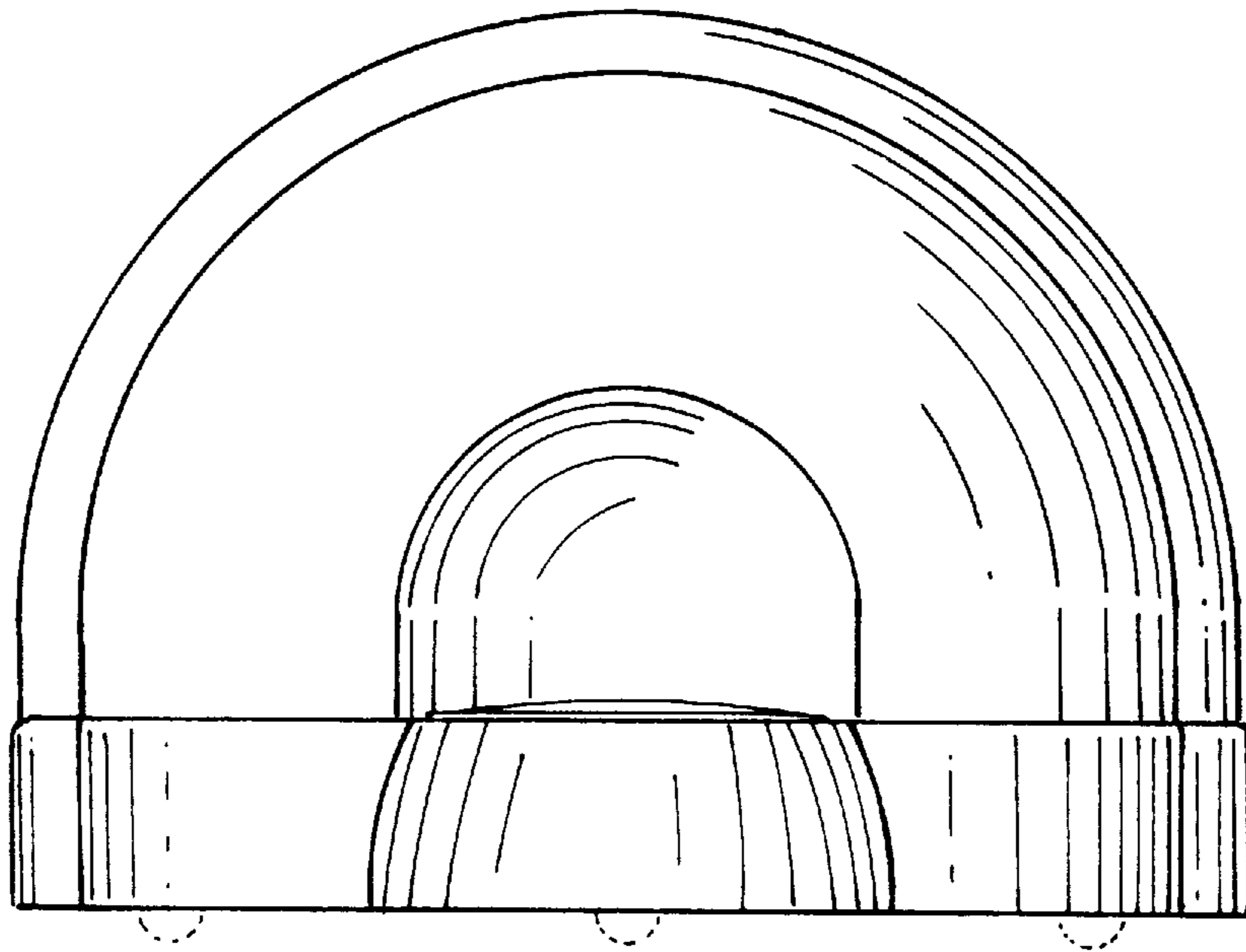

Fig. 9

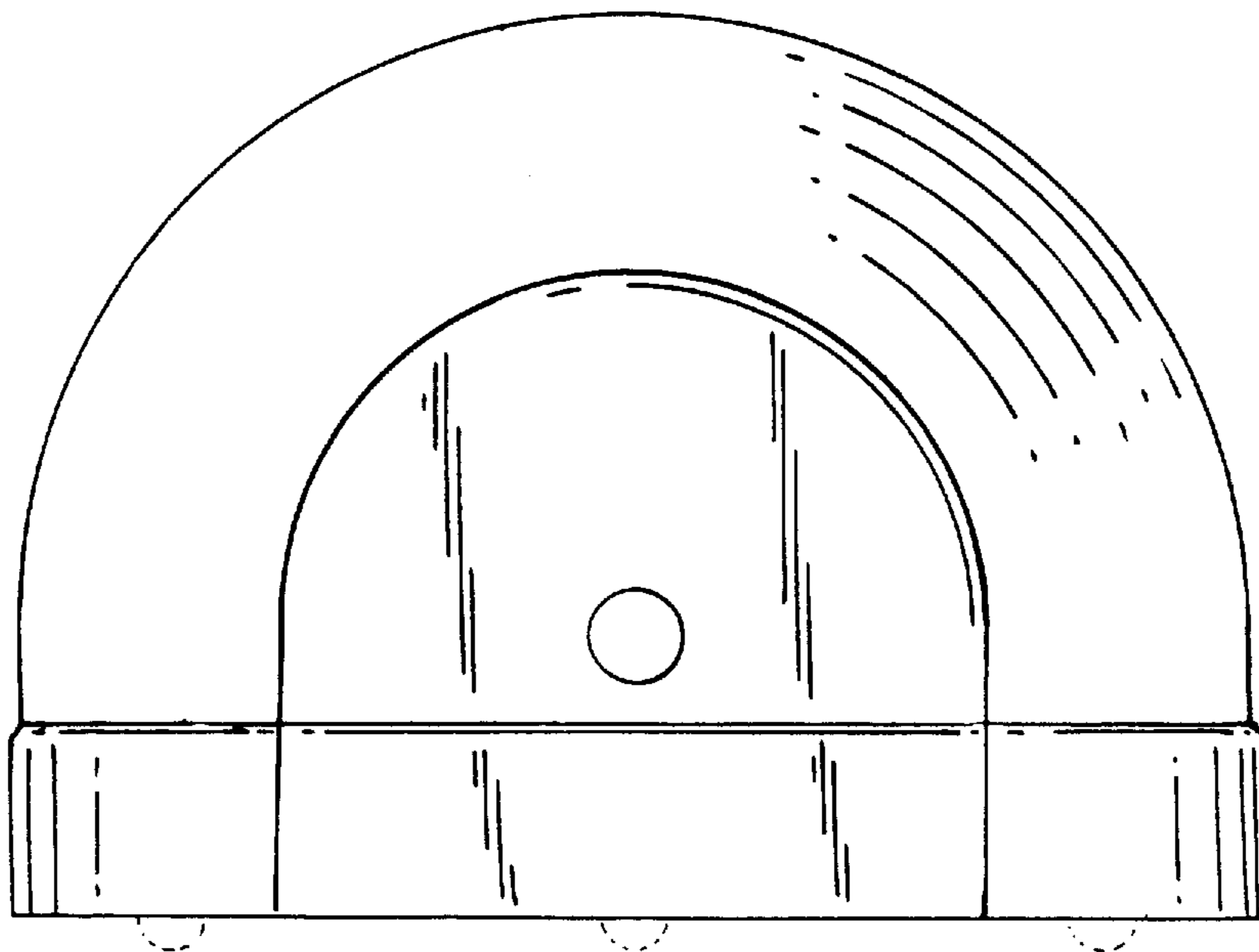

Fig. 10

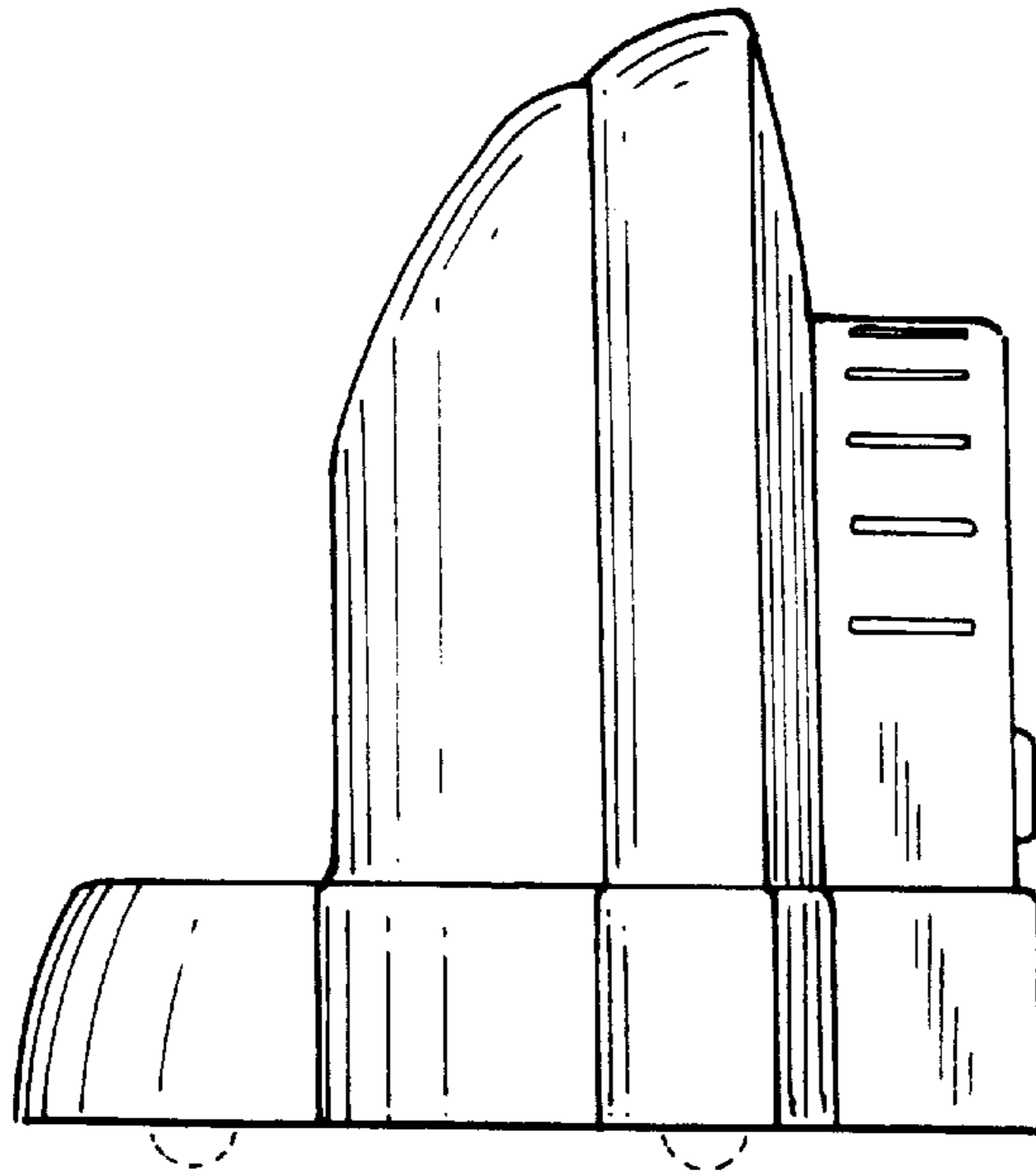

Fig. 11

