



US00D398218S

**United States Patent** [19]  
**Coll et al.**

[11] **Patent Number: Des. 398,218**

[45] **Date of Patent: \*\*Sep. 15, 1998**

[54] **CABLE CLIP AND FASTENER COMBINATION**

[75] Inventors: **Gene Coll**, Cranford, N.J.; **Cong Thanh Dinh**, Montreal, Canada

[73] Assignee: **Diamond Communication Products, Inc.**, Garwood, N.J.

[\*\*] Term: **14 Years**

[21] Appl. No.: **76,049**

[22] Filed: **Sep. 5, 1997**

[51] **LOC (6) Cl.** ..... **08-05**

[52] **U.S. Cl.** ..... **D8/356**

[58] **Field of Search** ..... D8/356, 371, 394, D8/396; 248/71, 74.1-74.4

[56] **References Cited**

**U.S. PATENT DOCUMENTS**

D. 331,358	12/1992	Sachs	.....	D8/356
D. 342,013	12/1993	Sachs	.....	D8/356
2,681,196	6/1954	Lind	.....	248/71

*Primary Examiner*—Holly Baynham

*Attorney, Agent, or Firm*—Foley & Lardner

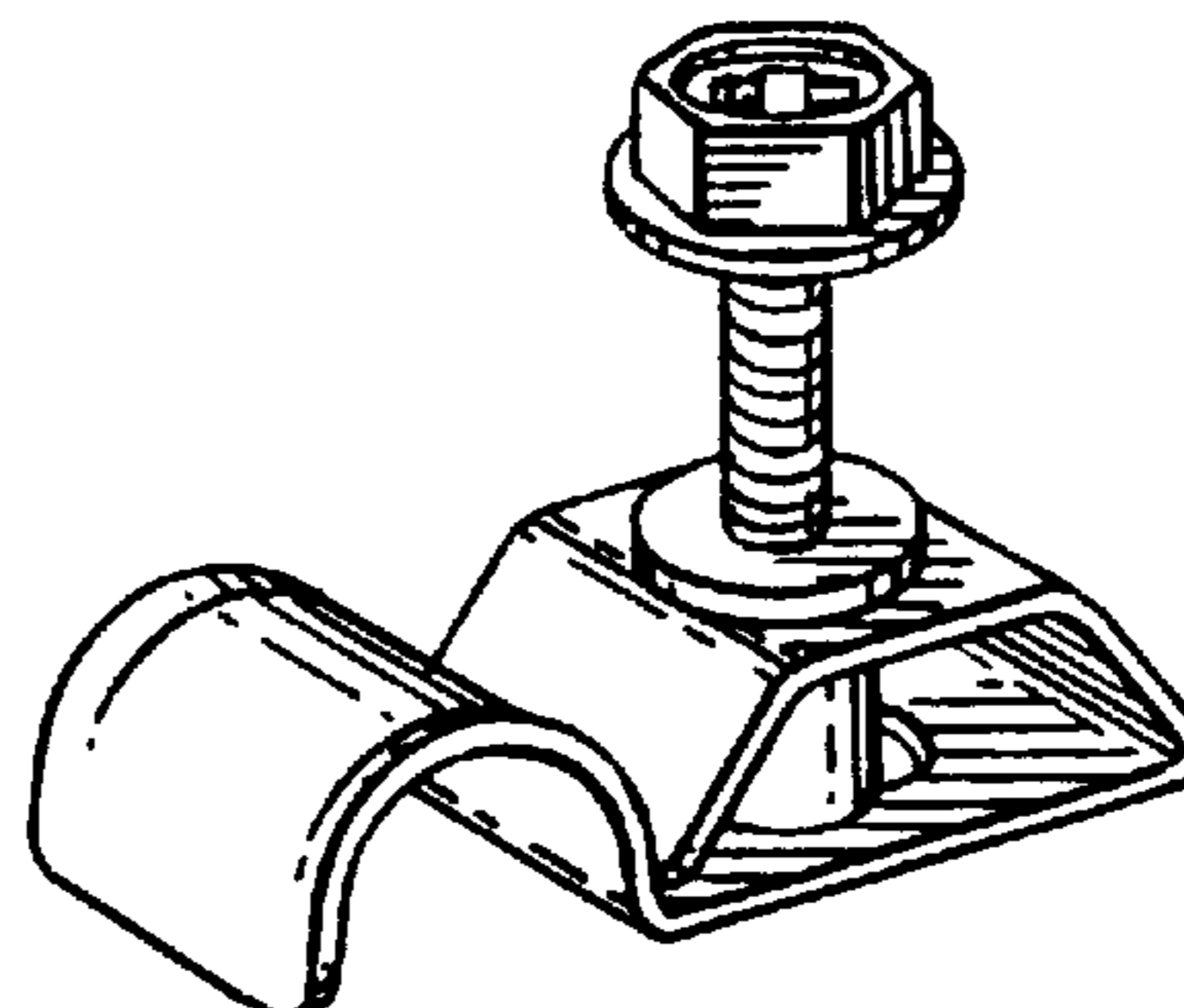
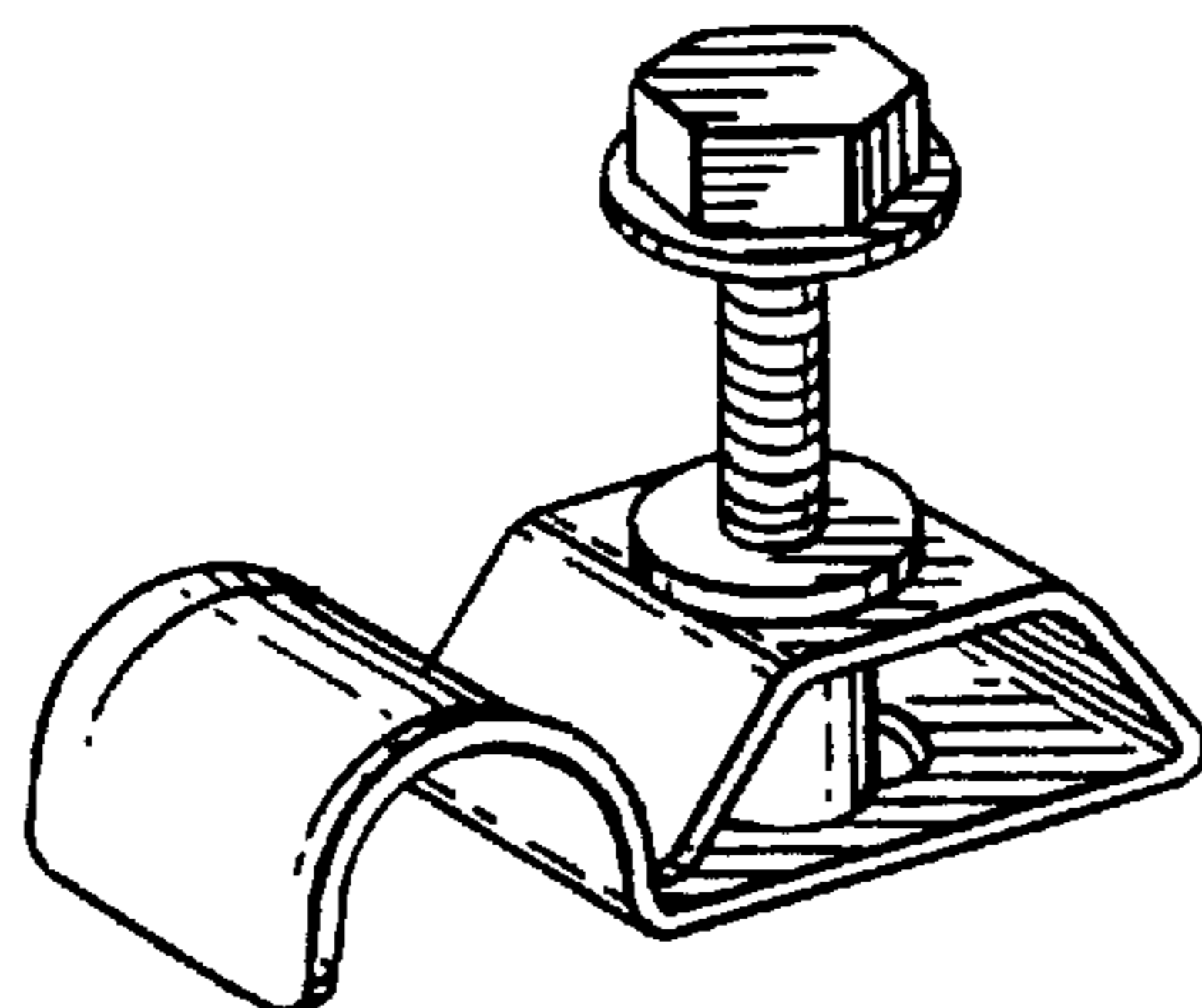
[57] **CLAIM**

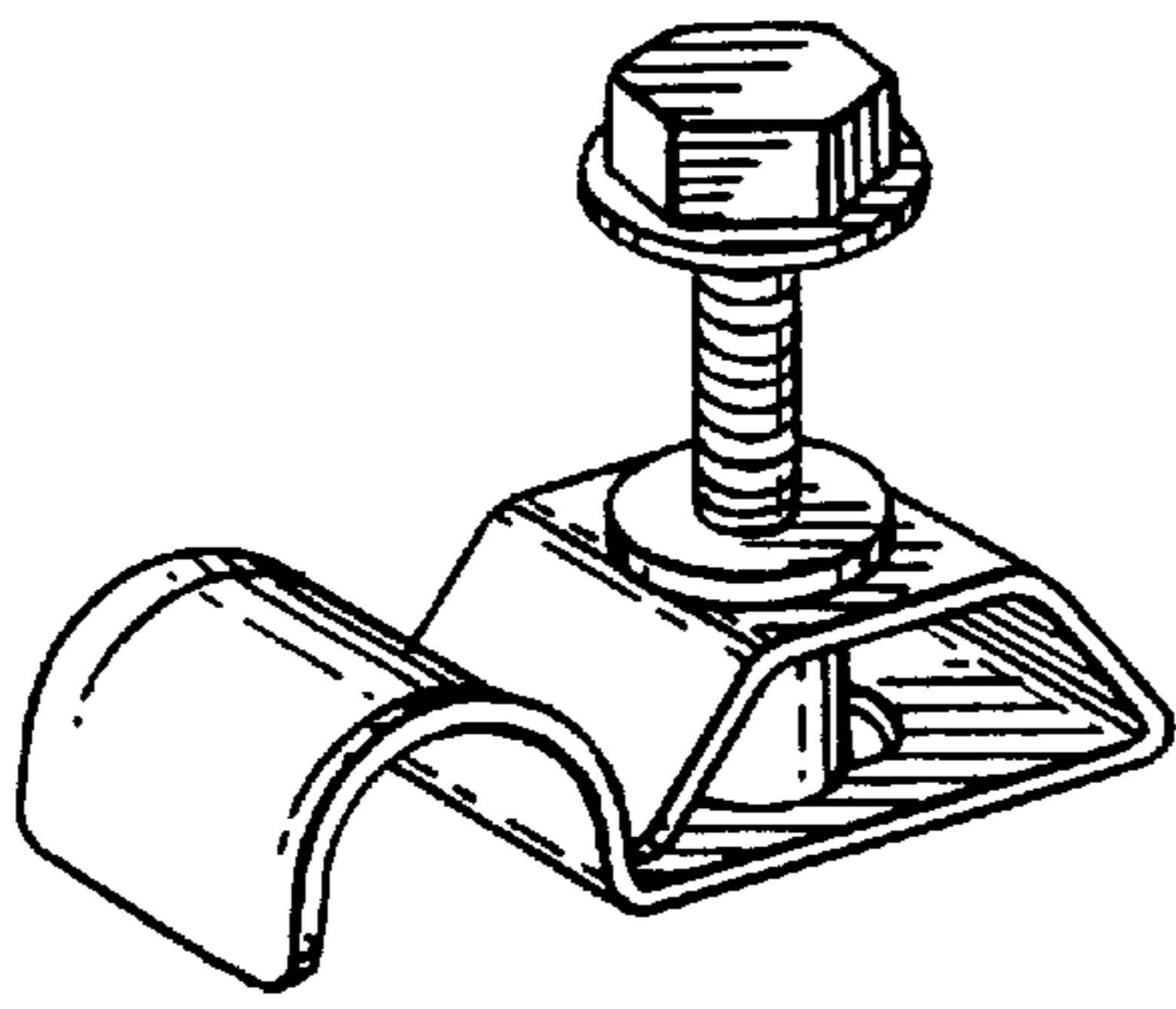
The ornamental design for a “cable clip and fastener combination”, as shown and described.

**DESCRIPTION**

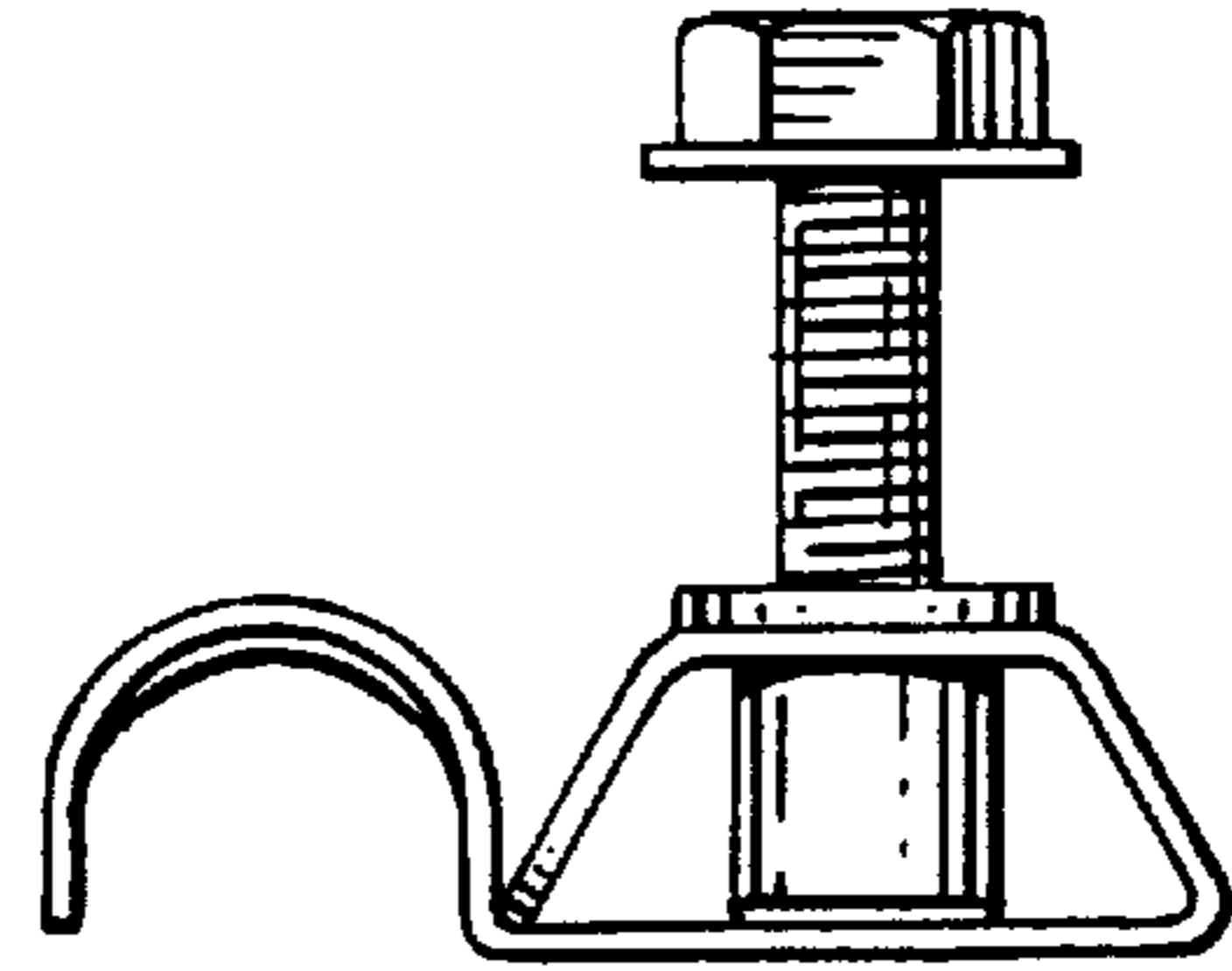
FIG. 1 is a top perspective view of a cable clip and fastener combination, showing a first embodiment of our new design; FIG. 2 is a side elevational view thereof, the opposite side being a mirror image of that shown; FIG. 3 is a left end elevational view thereof; FIG. 4 is a right end elevational view thereof; FIG. 5 is a top plan elevational view thereof; FIG. 6 is a bottom plan view thereof; FIG. 7 is a top perspective view of a cable clip and fastener combination, showing a second embodiment of our new design; FIG. 8 is a side elevational view thereof, the opposite side being a mirror image of that shown; FIG. 9 is a left end elevational view thereof; FIG. 10 is a right end elevational view thereof; FIG. 11 is a top plan elevational view thereof; and, FIG. 12 is a bottom plan view thereof.

**1 Claim, 2 Drawing Sheets**

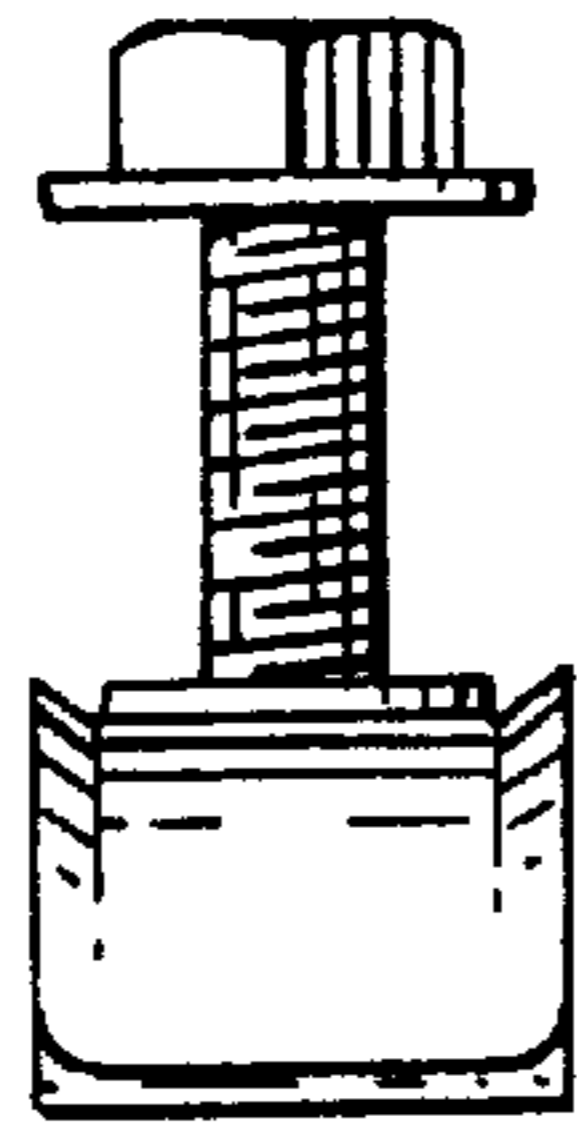




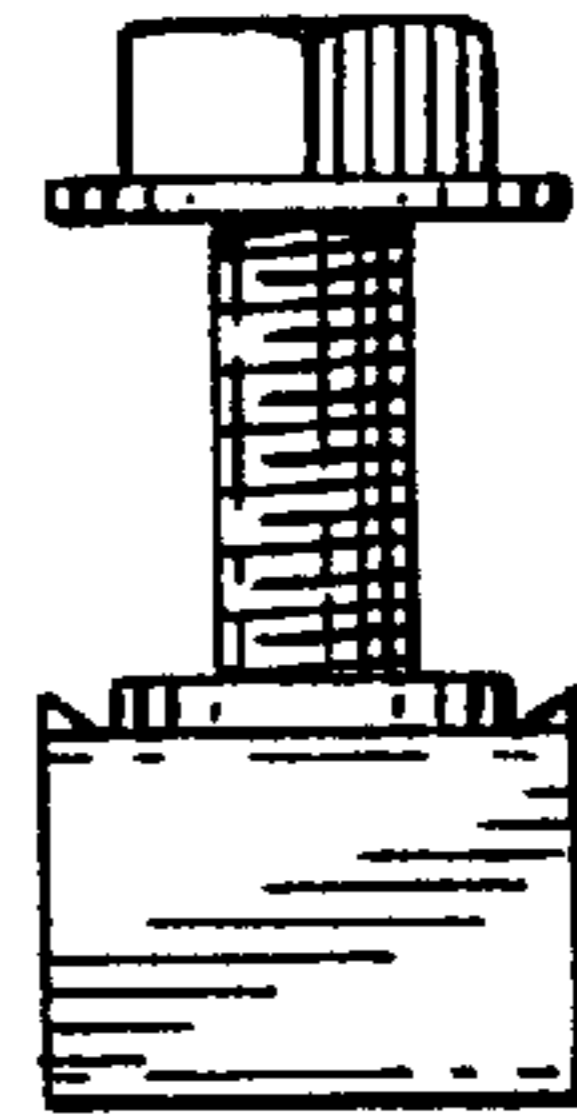
*Fig. 1*



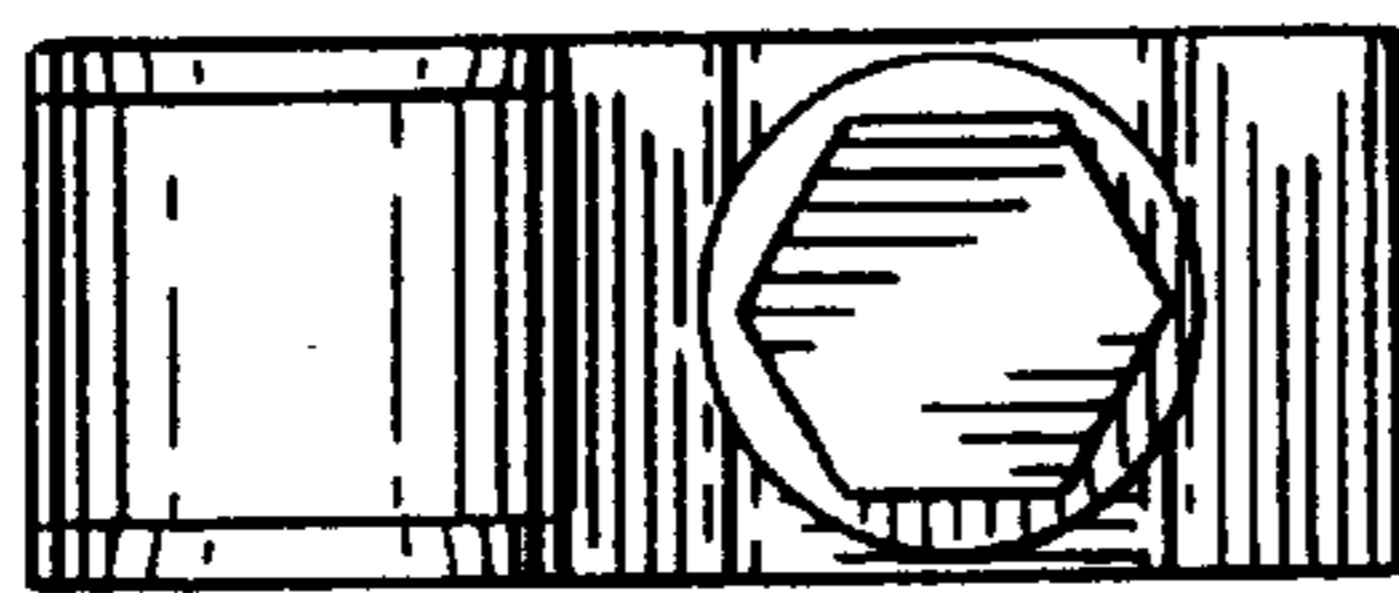
*Fig. 2*



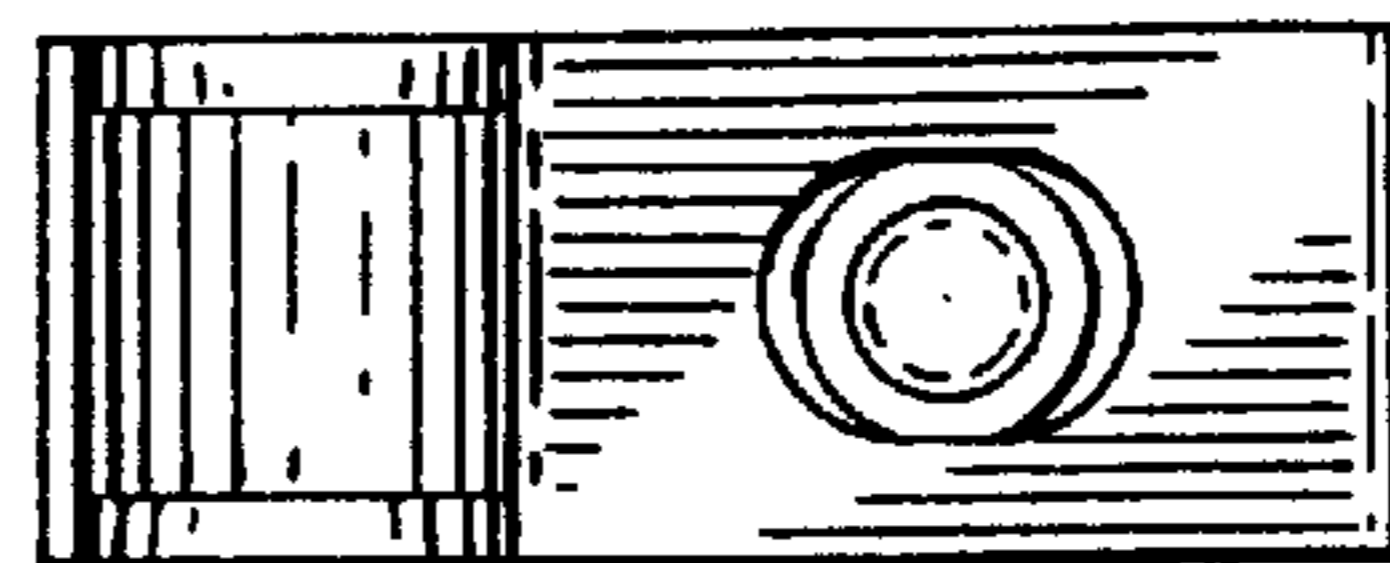
*Fig. 3*



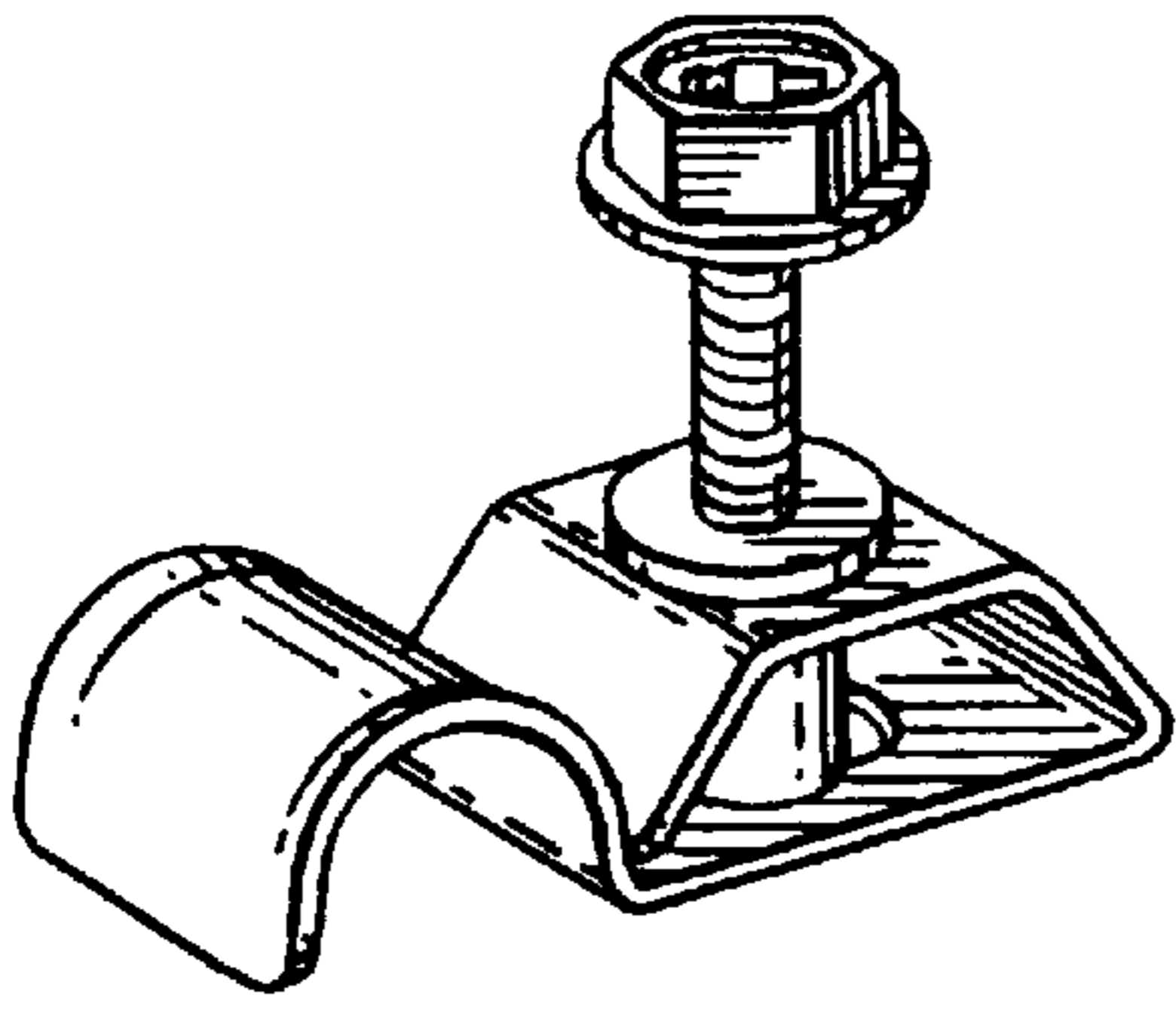
*Fig. 4*



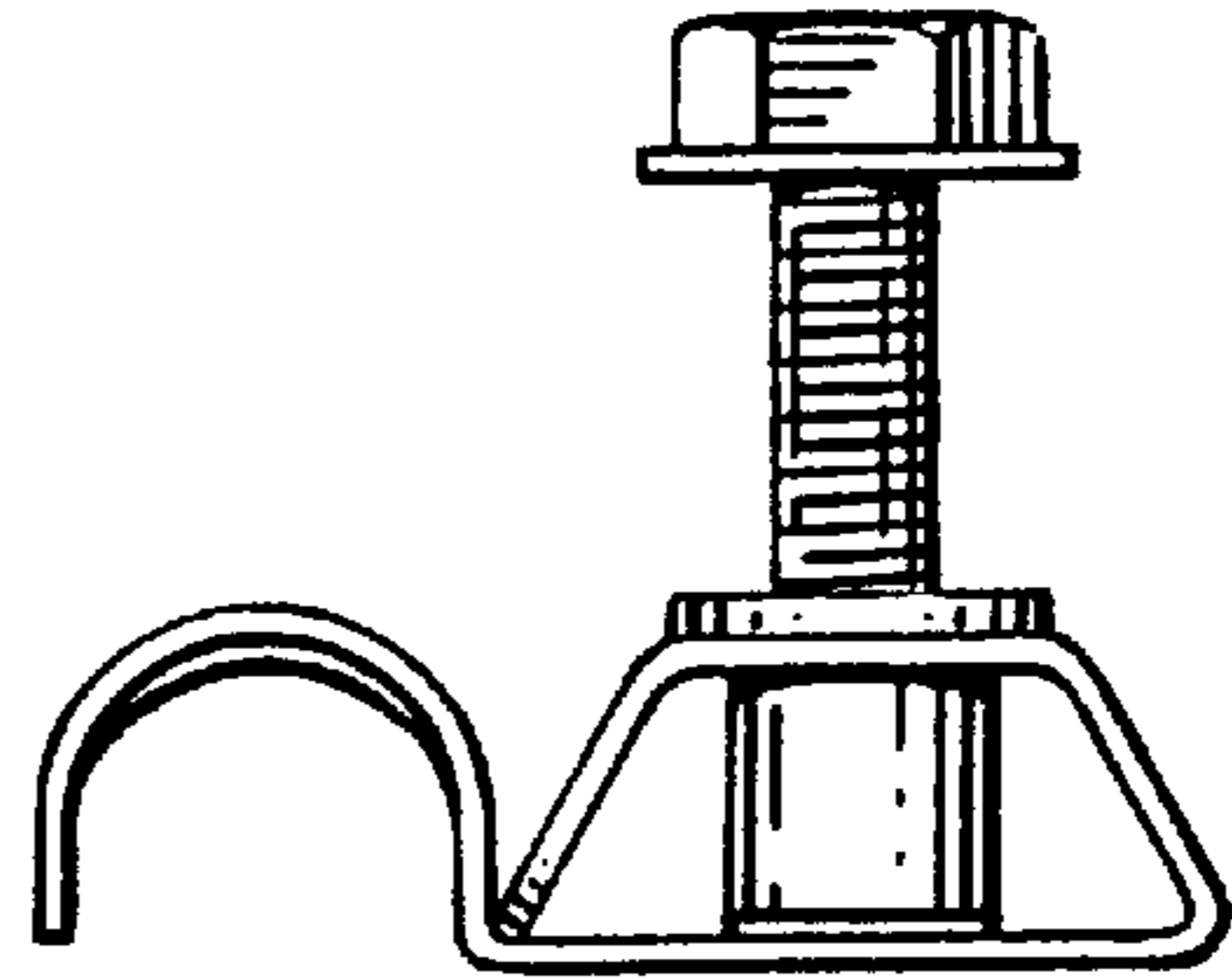
*Fig. 5*



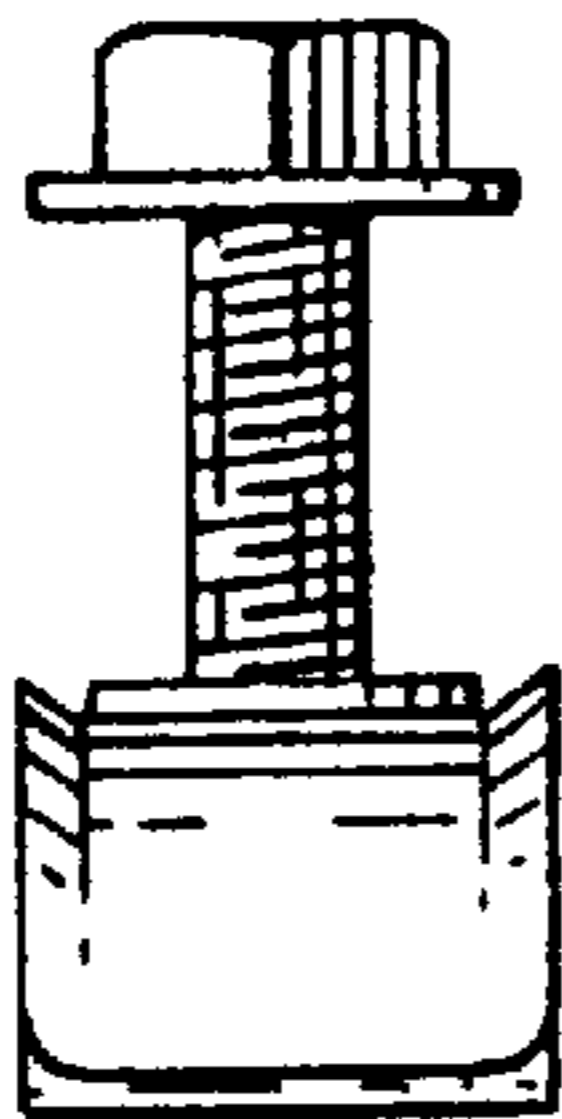
*Fig. 6*



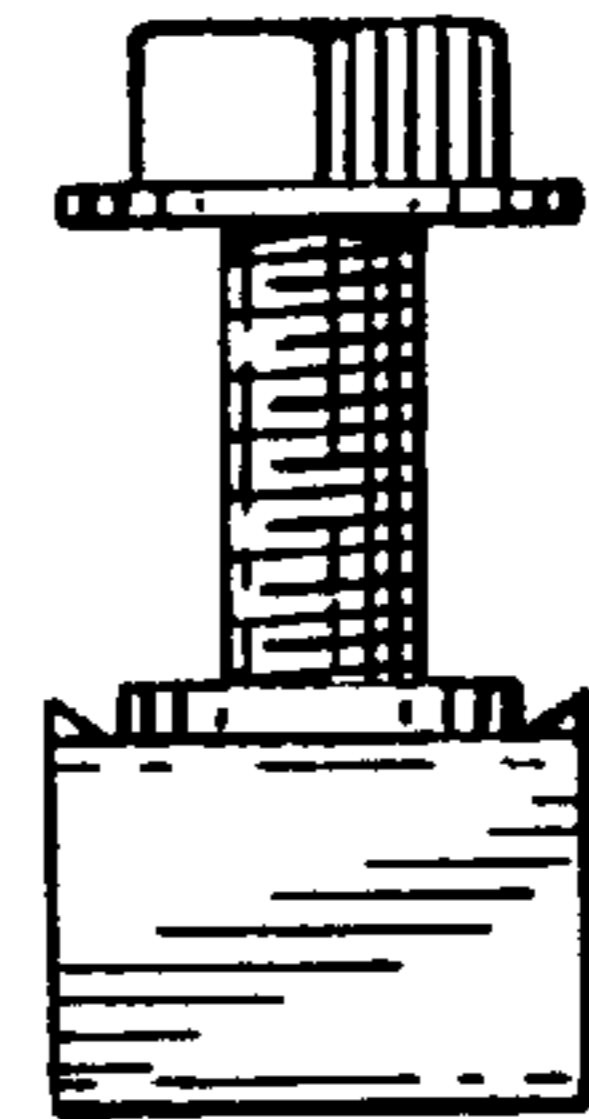
*Fig. 7*



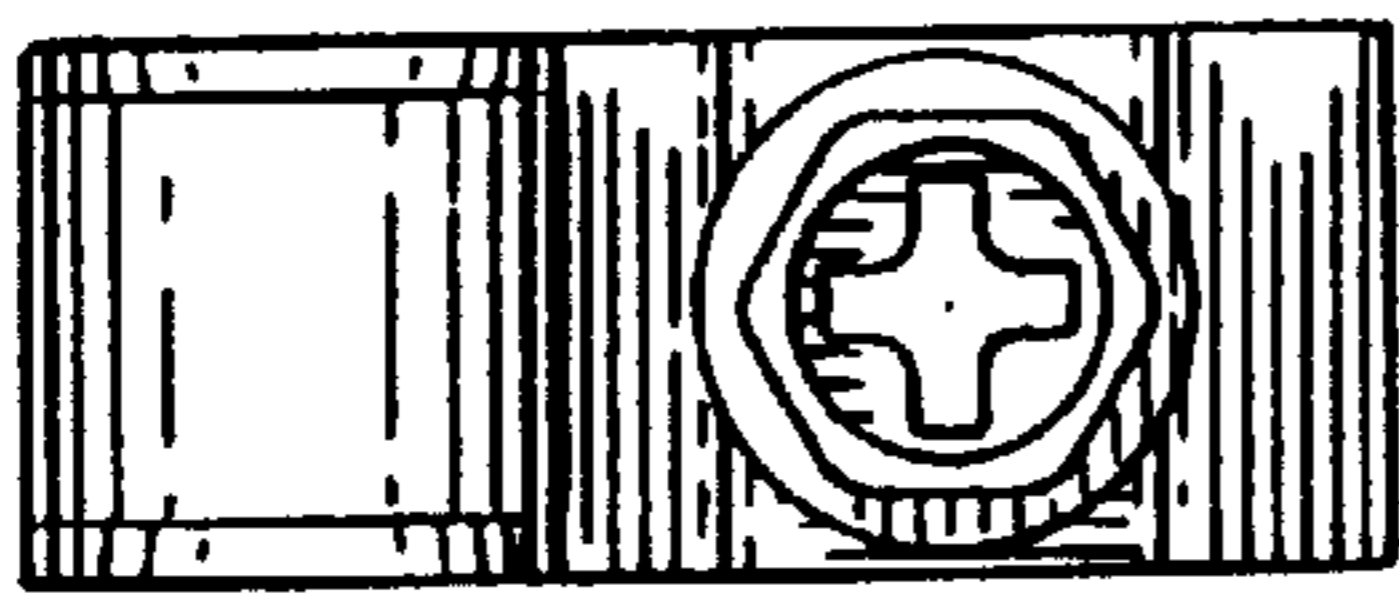
*Fig. 8*



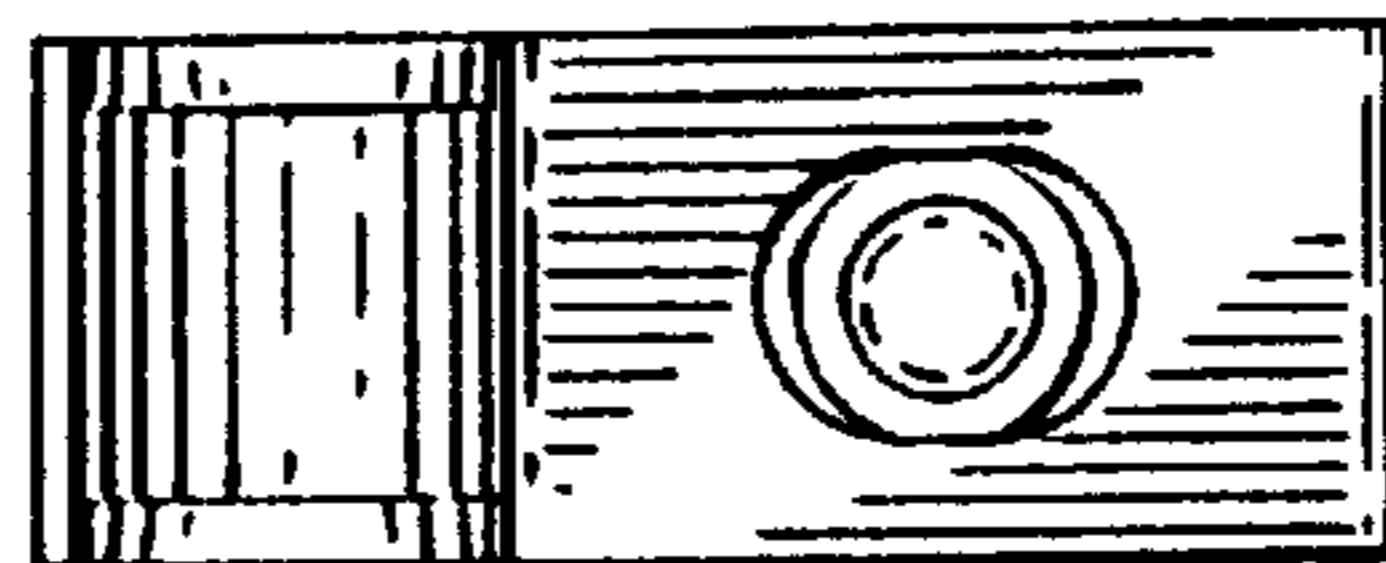
*Fig. 9*



*Fig. 10*



*Fig. 11*



*Fig. 12*