



US00D398204S

United States Patent [19]
Lee

[11] **Patent Number: Des. 398,204**

[45] **Date of Patent: **Sep. 15, 1998**

[54] **GLUE GUN**

5,462,206 10/1995 Kwasie 222/146.5
5,664,701 9/1997 Massena 222/146.5

[75] Inventor: **Grace Lee**, Chia Yi Hsien, Taiwan

[73] Assignee: **Homease Industrial Co., Ltd.**, Taiwan

[**] Term: **14 Years**

Primary Examiner—Antoine Duval Davis
Attorney, Agent, or Firm—Larson & Taylor

[21] Appl. No.: **70,622**

[22] Filed: **May 12, 1997**

[57] **CLAIM**

The ornamental design for a glue gun, as shown.

[51] **LOC (6) Cl.** **08-05**

[52] **U.S. Cl.** **D8/14.1; D8/30**

[58] **Field of Search** D8/14.1, 30, 29.1,
D8/61, 68; D15/144, 144.1, 144.2; D19/66,
68; 222/146.5

DESCRIPTION

FIG. 1 is a perspective view of the glue gun showing my new design;

FIG. 2 is a top plan view thereof;

FIG. 3 is a front elevational view thereof;

FIG. 4 is a left side elevational view thereof;

FIG. 5 is a right side elevational view thereof;

FIG. 6 is a rear elevational view thereof; and,

FIG. 7 is a bottom plan view thereof.

[56] **References Cited**

U.S. PATENT DOCUMENTS

D. 303,612 9/1989 Knispel D8/14.1

1 Claim, 3 Drawing Sheets

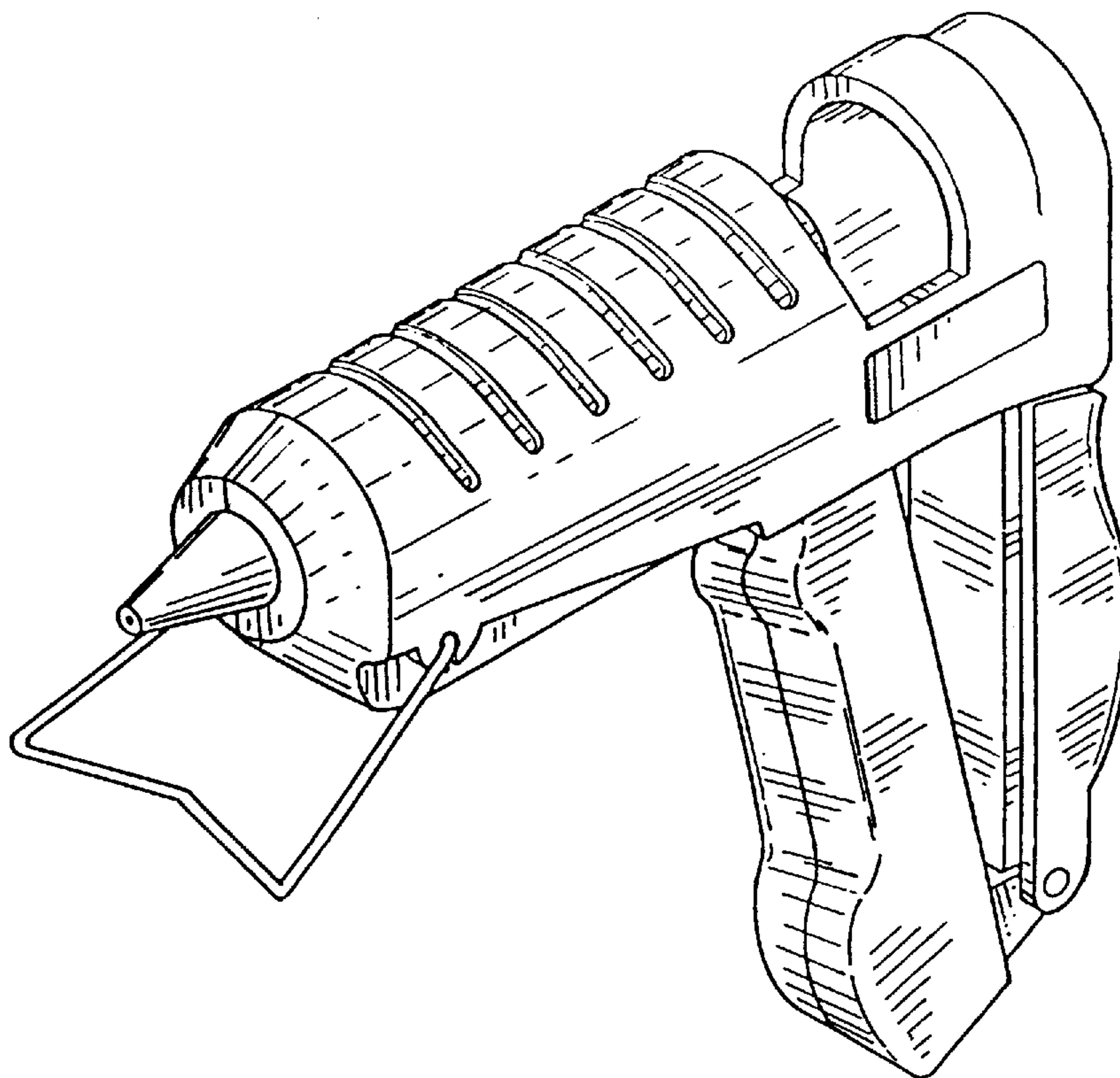

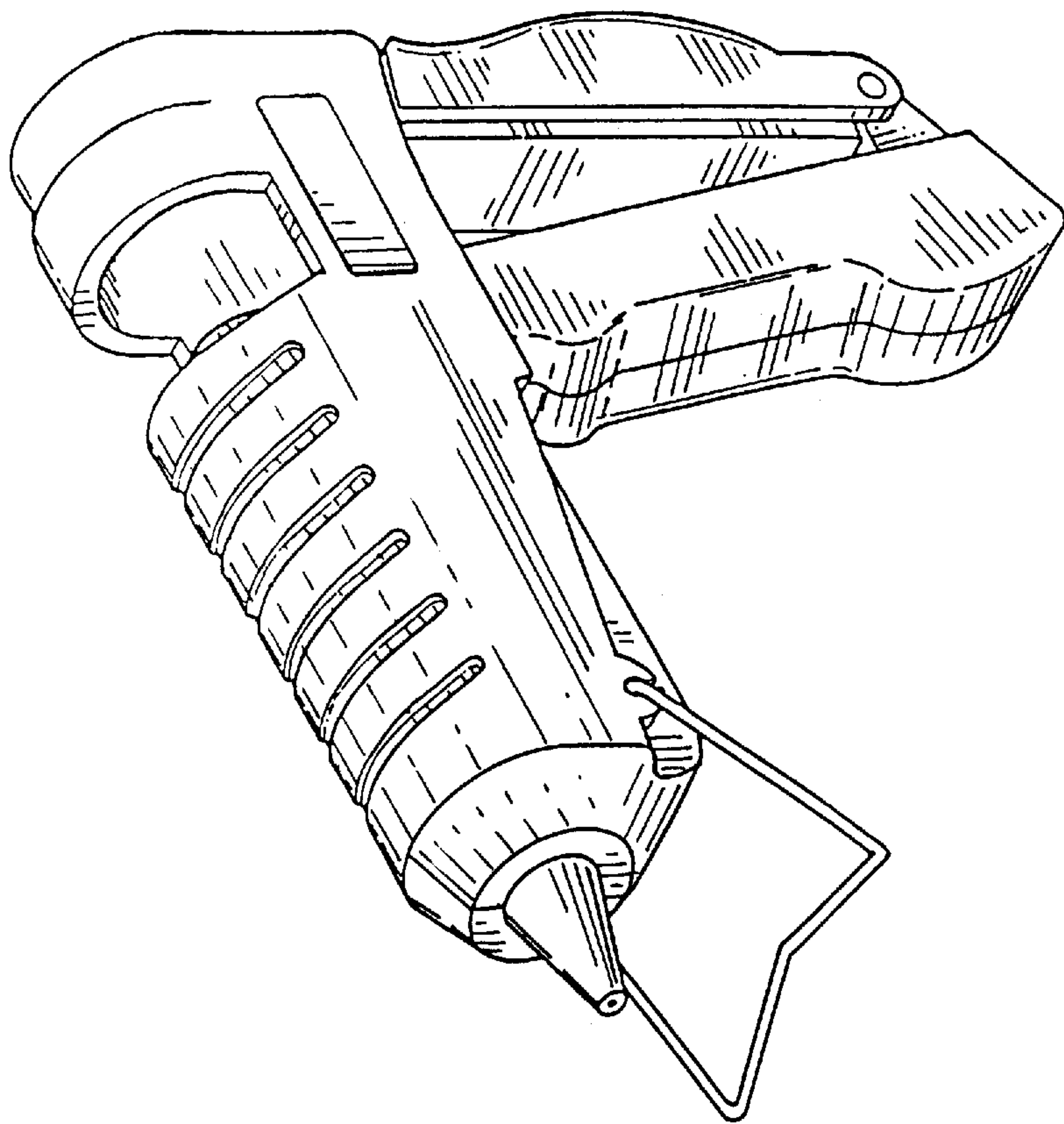

FIG. 1

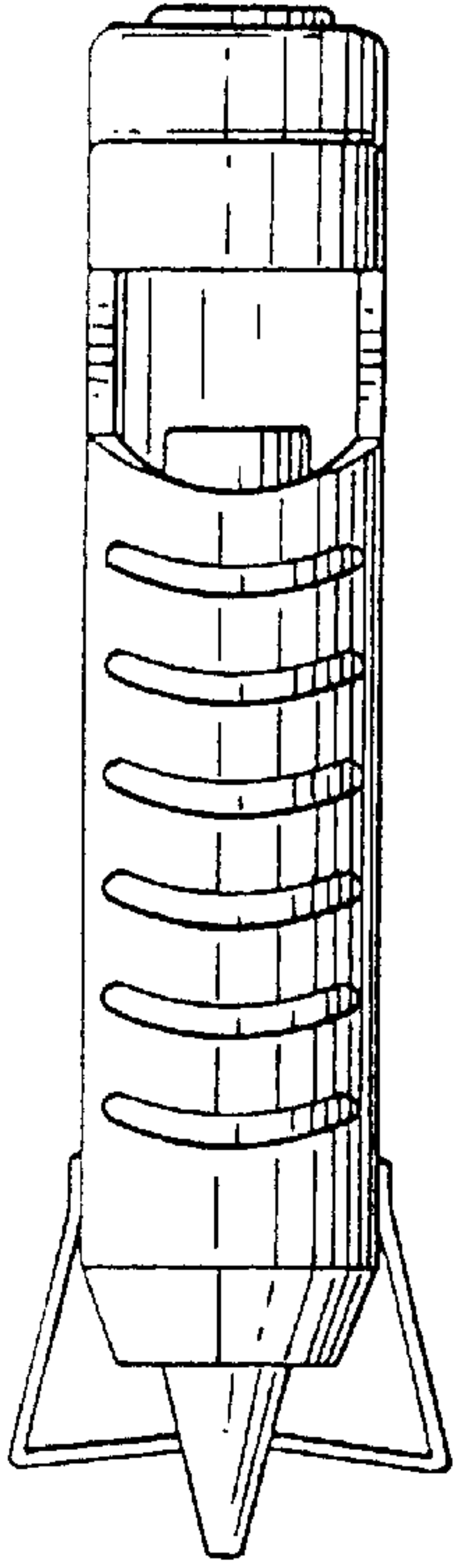

FIG. 2

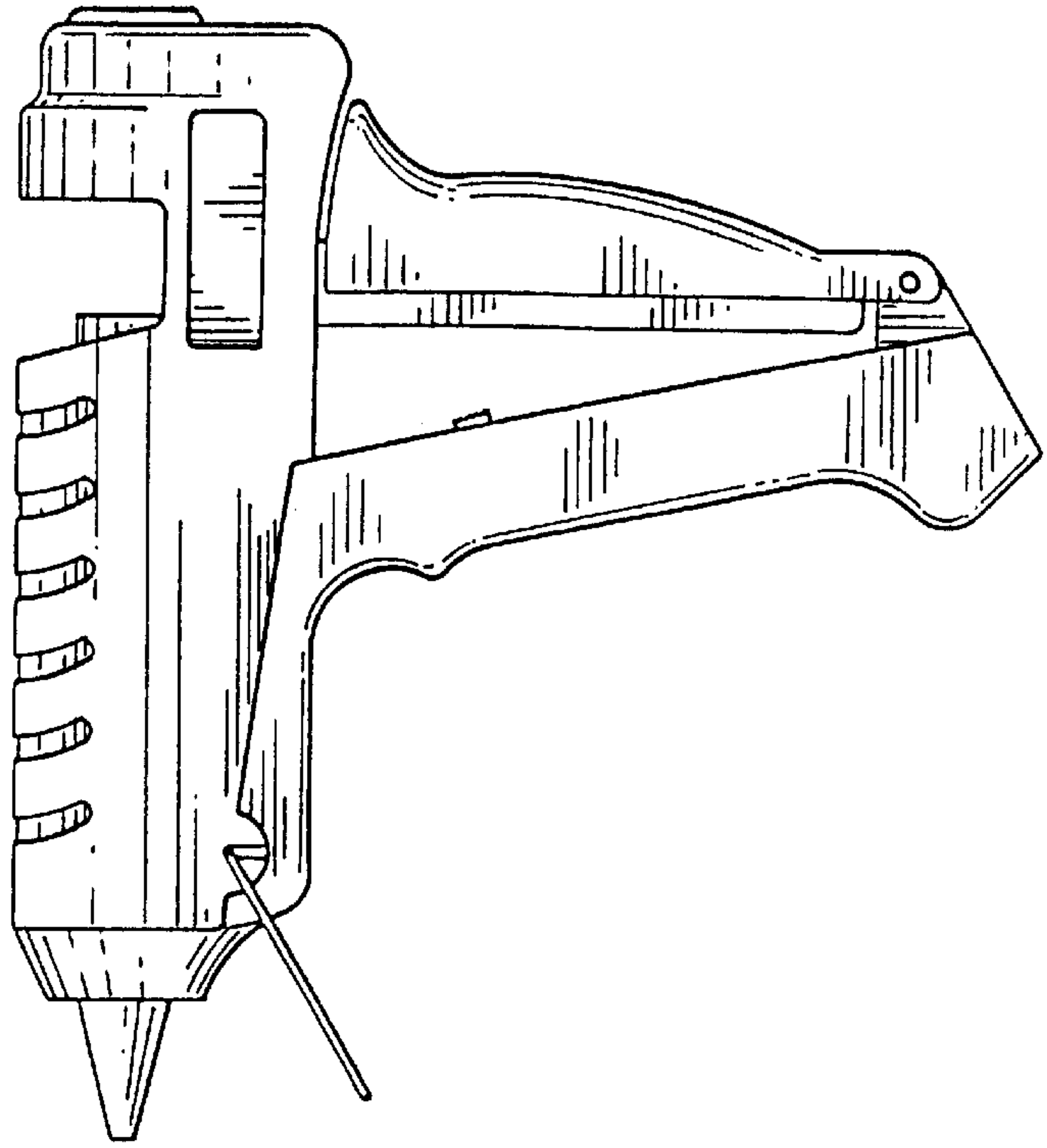

FIG. 3

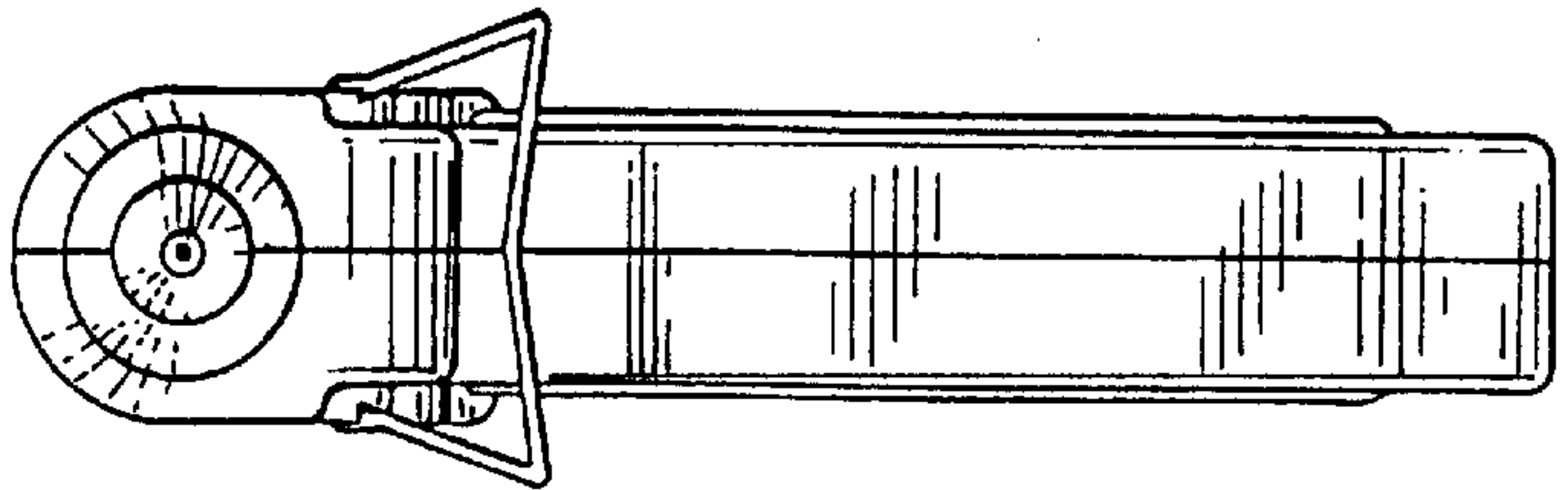

FIG. 4

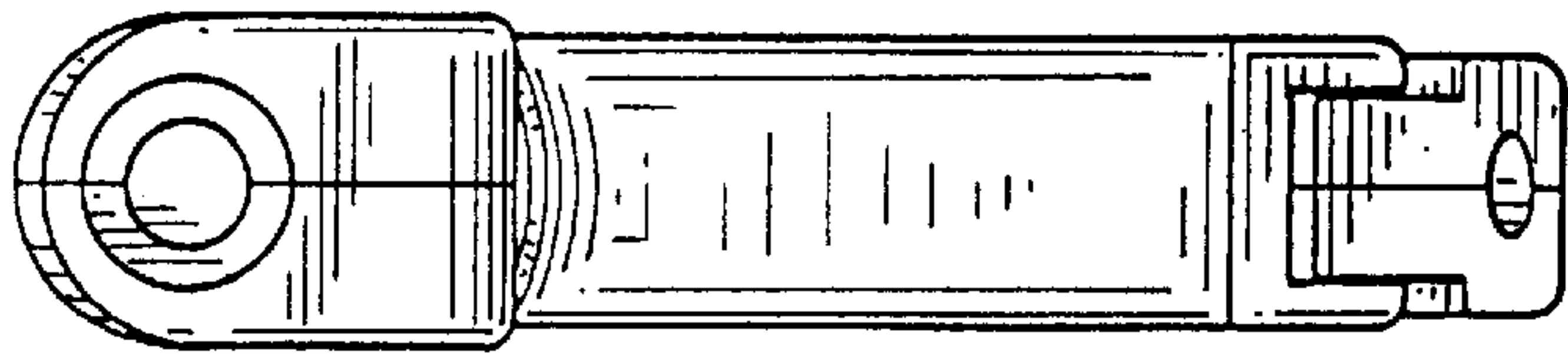

FIG. 5

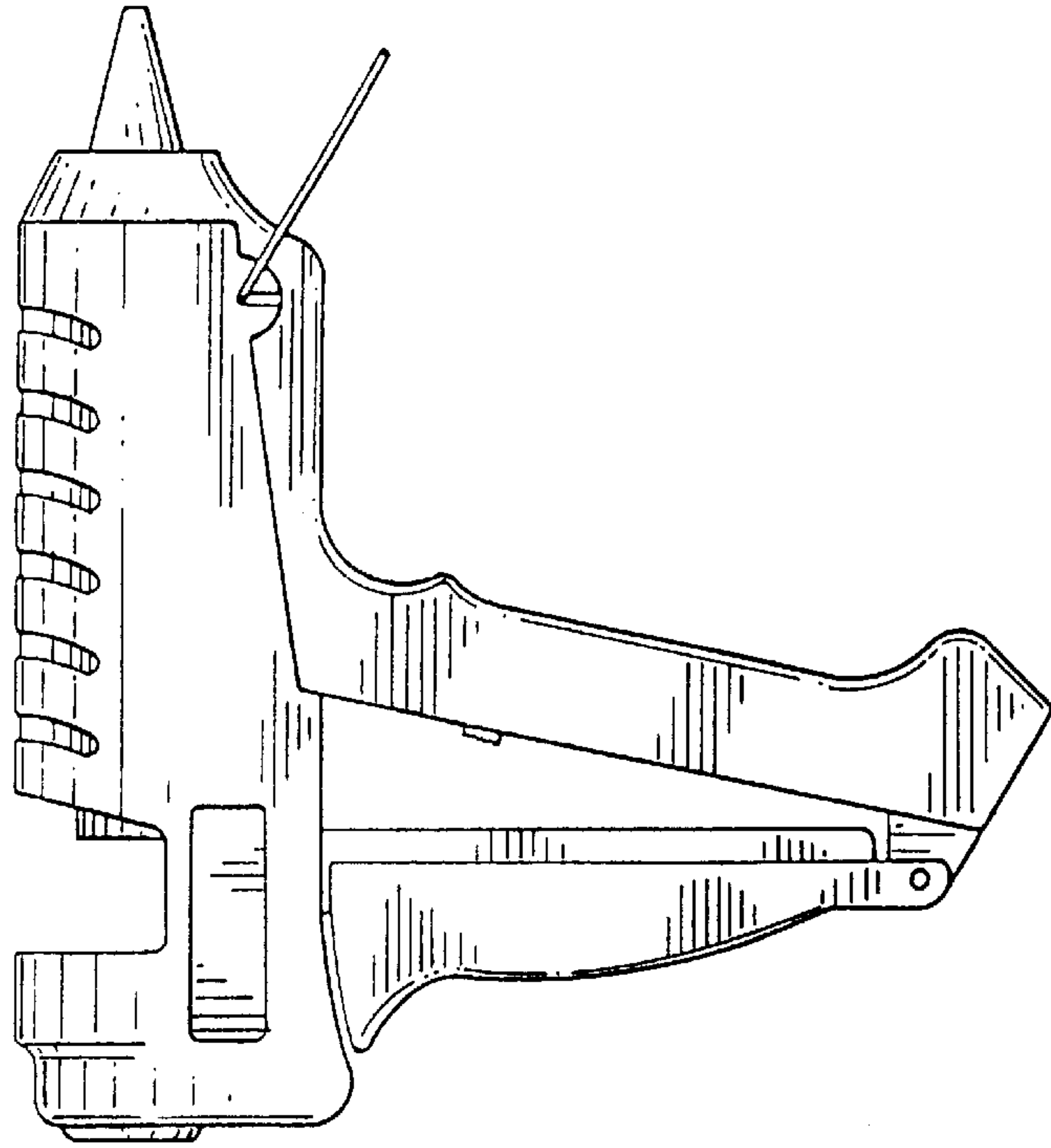

FIG. 6

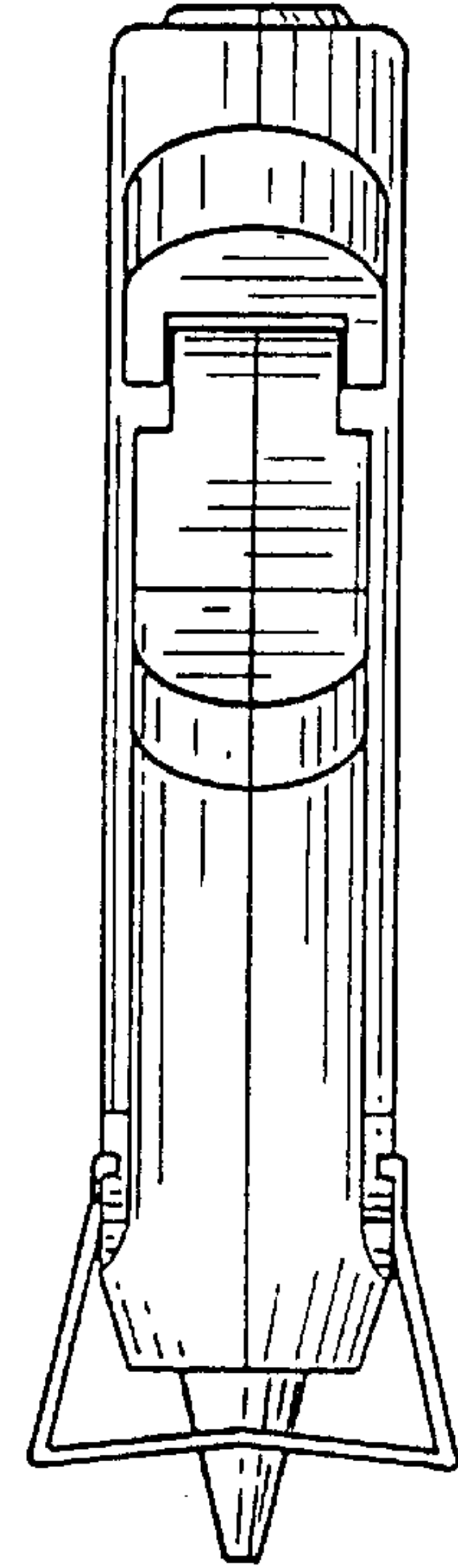

FIG. 7