



US00D398191S

United States Patent [19] Melk

[11] **Patent Number: Des. 398,191**

[45] **Date of Patent: **Sep. 15, 1998**

[54] **FLEXIBLE COOLER**

[75] Inventor: **Thomas J. Melk**, Chicago, Ill.

[73] Assignee: **Outer Circle Products, Ltd.**, Chicago, Ill.

[**] Term: **14 Years**

[21] Appl. No.: **62,007**

[22] Filed: **Nov. 5, 1996**

[51] **LOC (6) Cl. 07-01**

[52] **U.S. Cl. D7/607**

[58] **Field of Search** D3/201, 273, 276,
D3/283, 268, 301; D7/605-607, 709-710;
62/457.1, 457.7, 371; 220/410, 412; 150/107,
118, 119; 206/545, 549, 541, 548; 383/113

[56] **References Cited**

U.S. PATENT DOCUMENTS

D. 182,126	2/1958	Kontoff	D3/268
D. 284,333	6/1986	Huston	D3/283 X
D. 299,406	1/1989	Jacober	.	
D. 340,387	10/1993	Melk	.	
D. 340,621	10/1993	Melk	.	
D. 340,840	11/1993	Melk	D3/283 X
D. 371,051	6/1996	Melk	.	
D. 371,052	6/1996	Melk	.	
D. 371,724	7/1996	Melk	.	
D. 376,044	12/1996	Trawick et al.	D3/283
4,767,039	8/1988	Jacober	.	
5,403,095	4/1995	Melk	.	

OTHER PUBLICATIONS

“Coleman for 1986”, 5 pages, 1986.

“Coleman Collection '91 FREIZEIT live”, English edition, 2 pages, 1991.

Primary Examiner—Terry A. Wallace
Attorney, Agent, or Firm—Trexler, Bushnell, Giangiorgi & Blackstone, Ltd.

[57] **CLAIM**

The ornamental design for a flexible cooler, as shown and described.

DESCRIPTION

FIG. 1 is a perspective view of a flexible cooler showing my new design;

FIG. 2 is a perspective view of an alternate embodiment of FIG. 1;

FIG. 3 is a perspective view of an alternate embodiment of FIG. 1;

FIG. 4 is a front elevation view of FIG. 1;

FIG. 5 is a front elevation view of FIG. 2;

FIG. 6 is a front elevation view of FIG. 3;

FIG. 7 is a rear elevation view of FIG. 1;

FIG. 8 is a rear elevation view of FIG. 2;

FIG. 9 is a rear elevation view of FIG. 3;

FIG. 10 is a top plan view of FIG. 1;

FIG. 11 is a top plan view of FIG. 2;

FIG. 12 is a top plan view of FIG. 3;

FIG. 13 is a right side elevation view of FIG. 1;

FIG. 14 is a right side elevation view of FIG. 2;

FIG. 15 is a right side elevation view of FIG. 3;

FIG. 16 is a left side elevation view of FIG. 1;

FIG. 17 is a left side elevation view of FIG. 2;

FIG. 18 is a left side elevation view of FIG. 3;

FIG. 19 is a bottom plan view of FIG. 1;

FIG. 20 is a bottom plan view of FIG. 2; and,

FIG. 21 is a bottom plan view of FIG. 3.

1 Claim, 7 Drawing Sheets

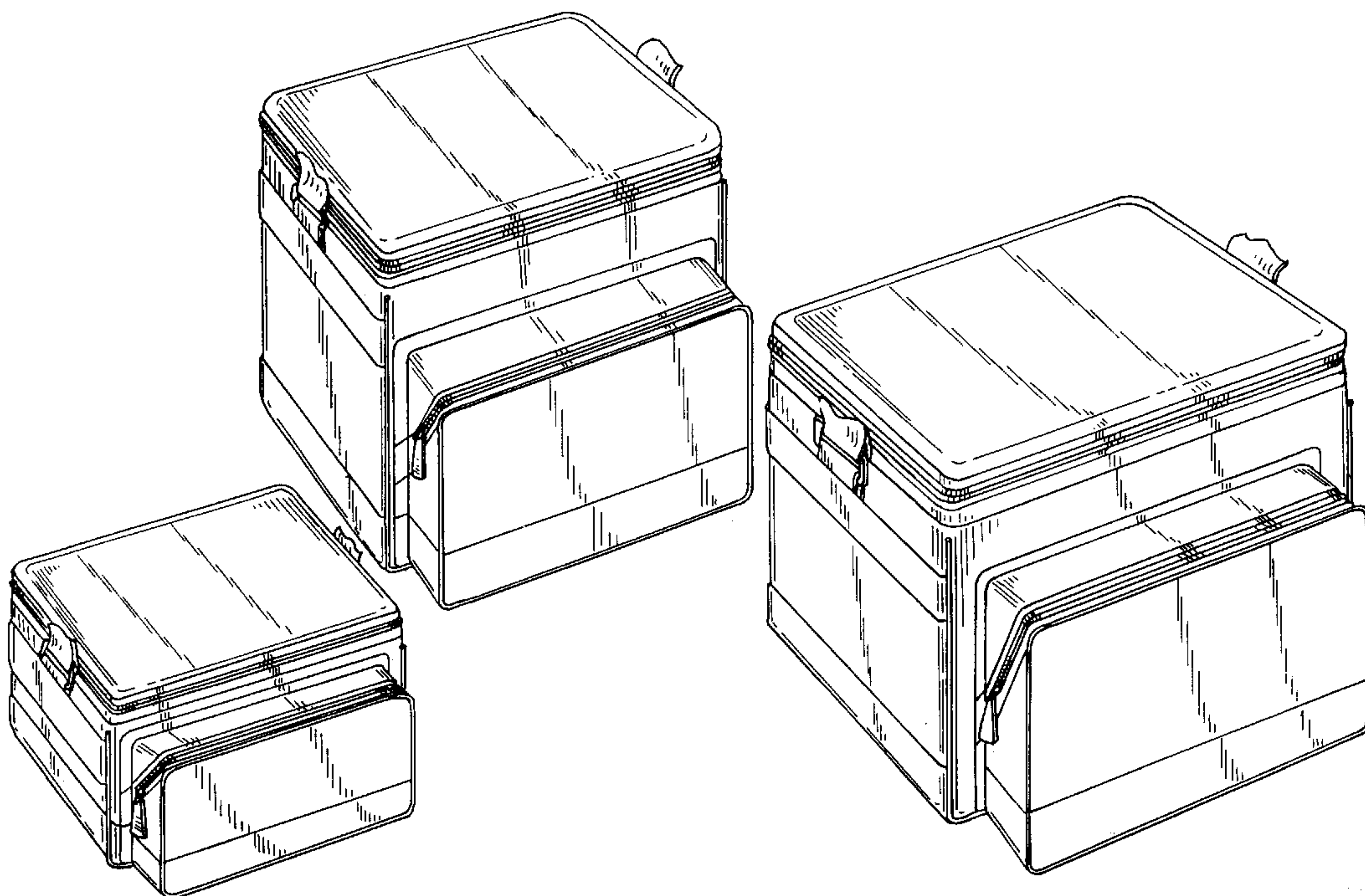

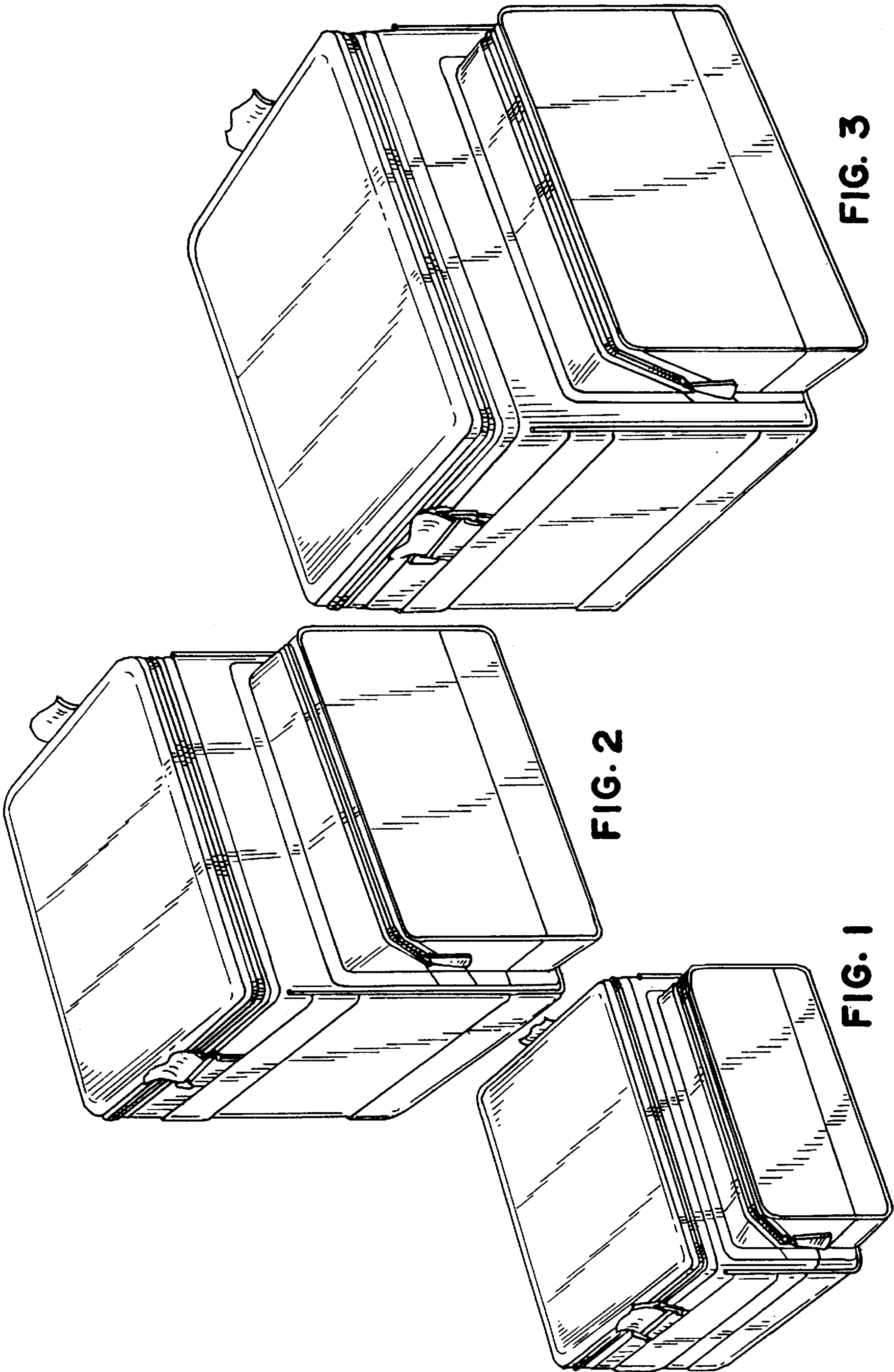

FIG. 3

FIG. 2

FIG. 1

FIG. 4

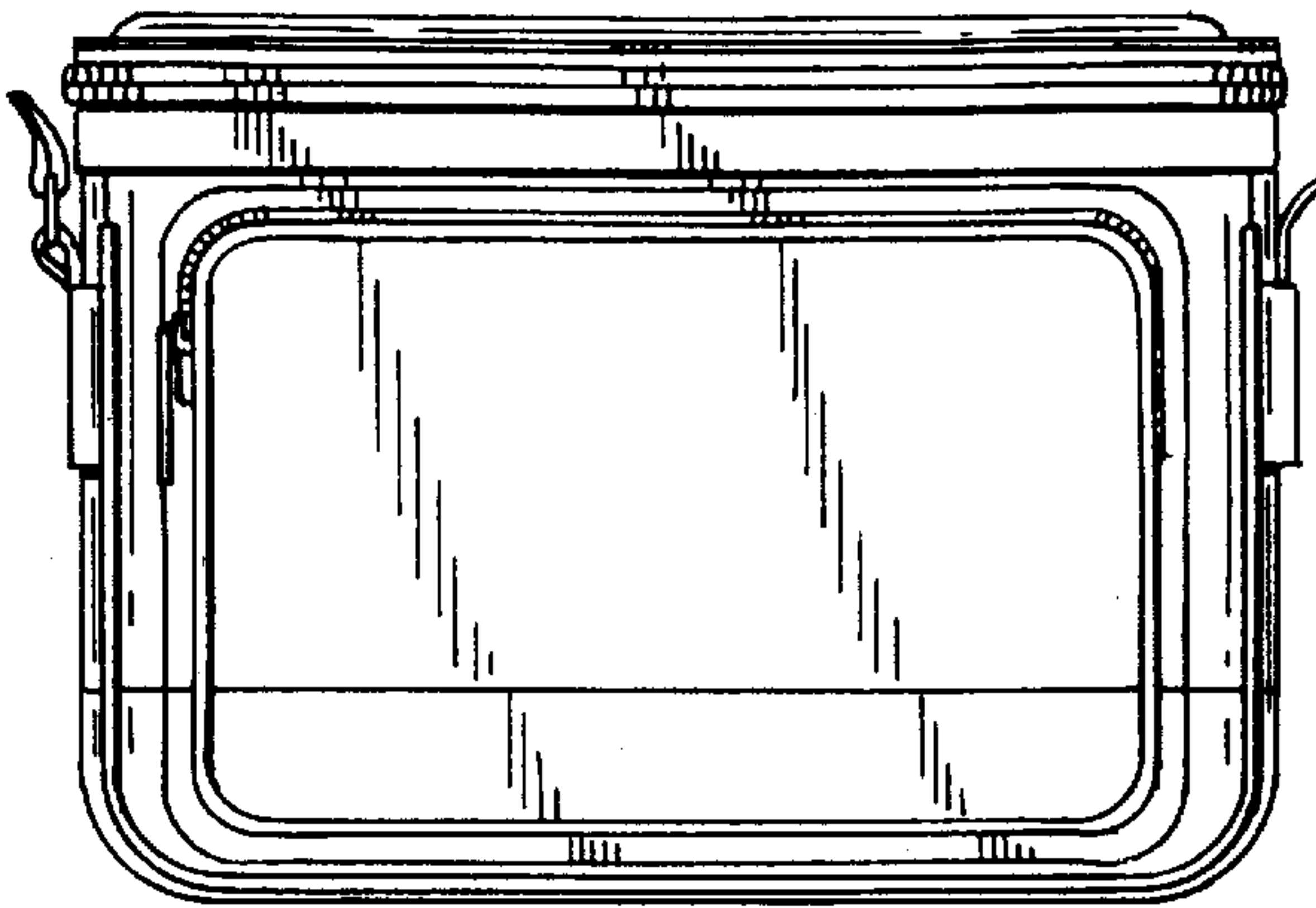

FIG. 5

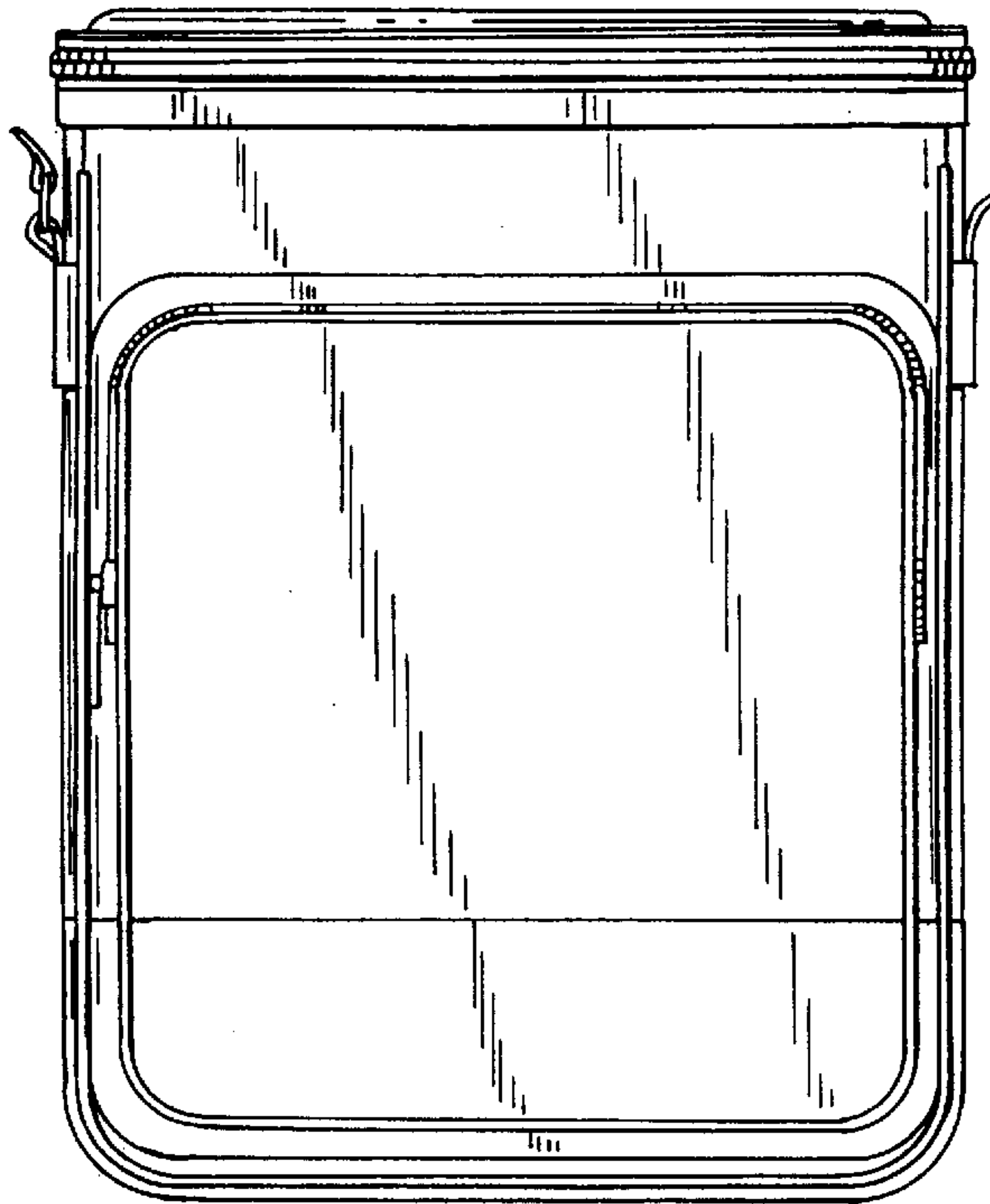

FIG. 6

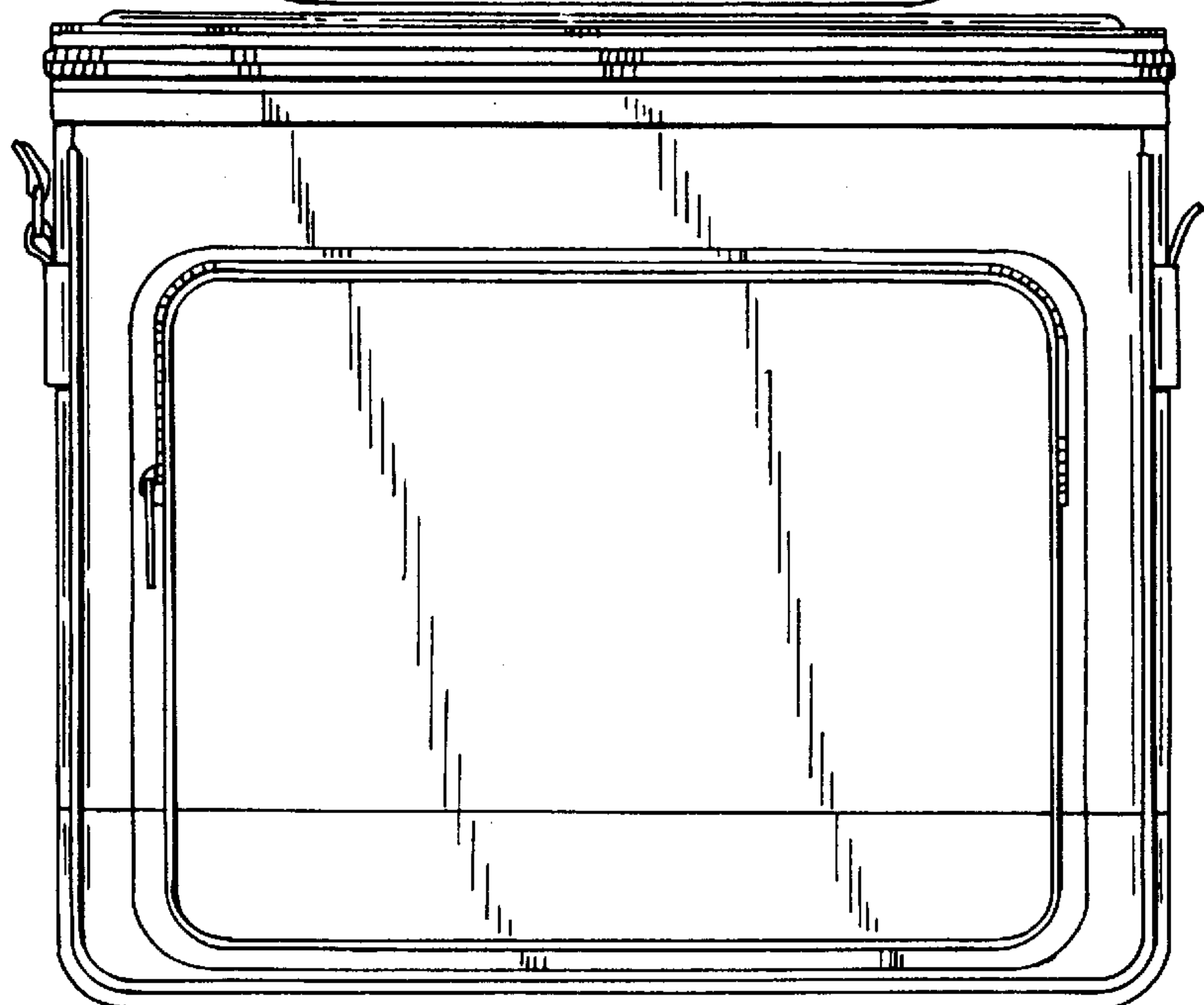

FIG. 7

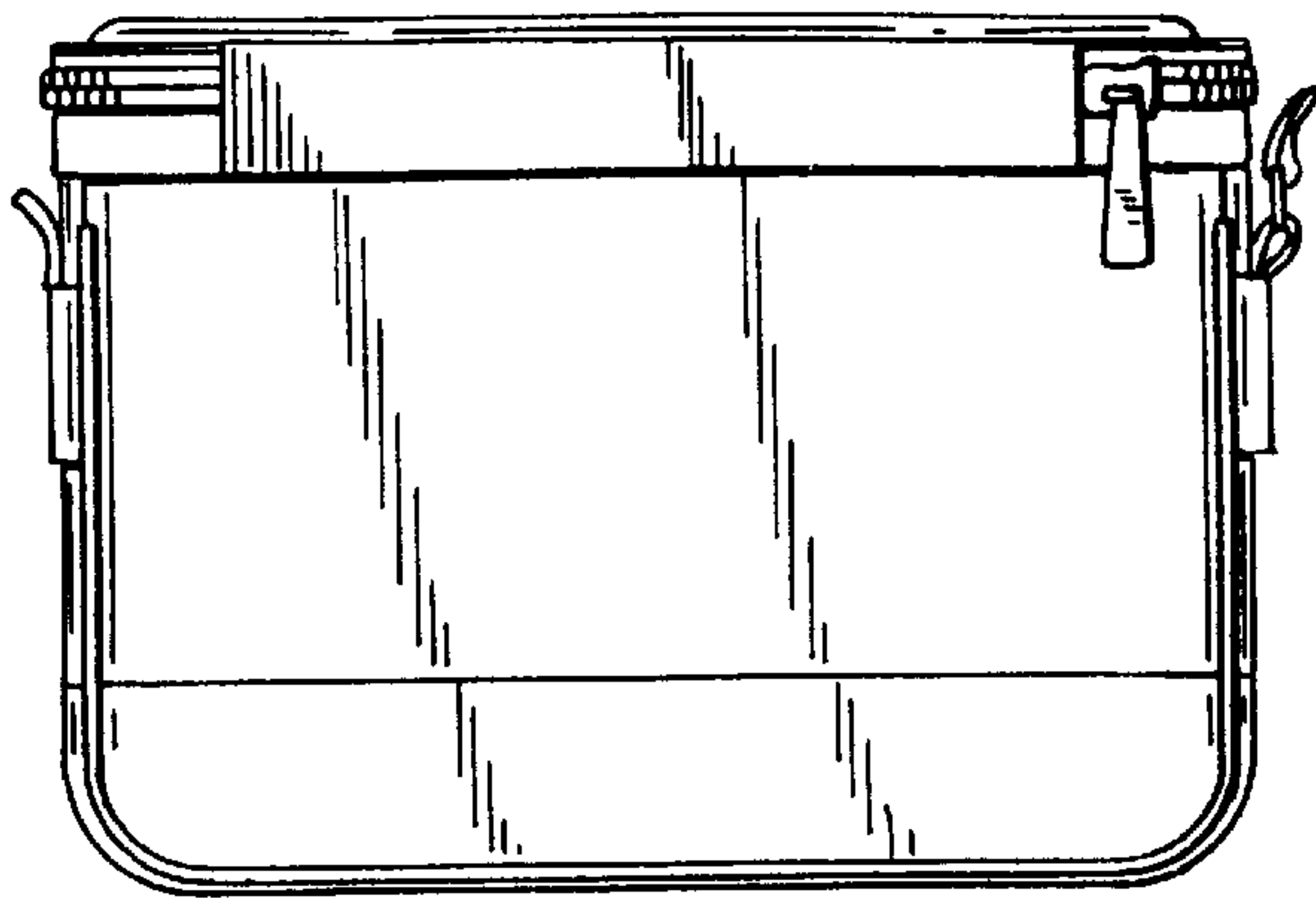

FIG. 8

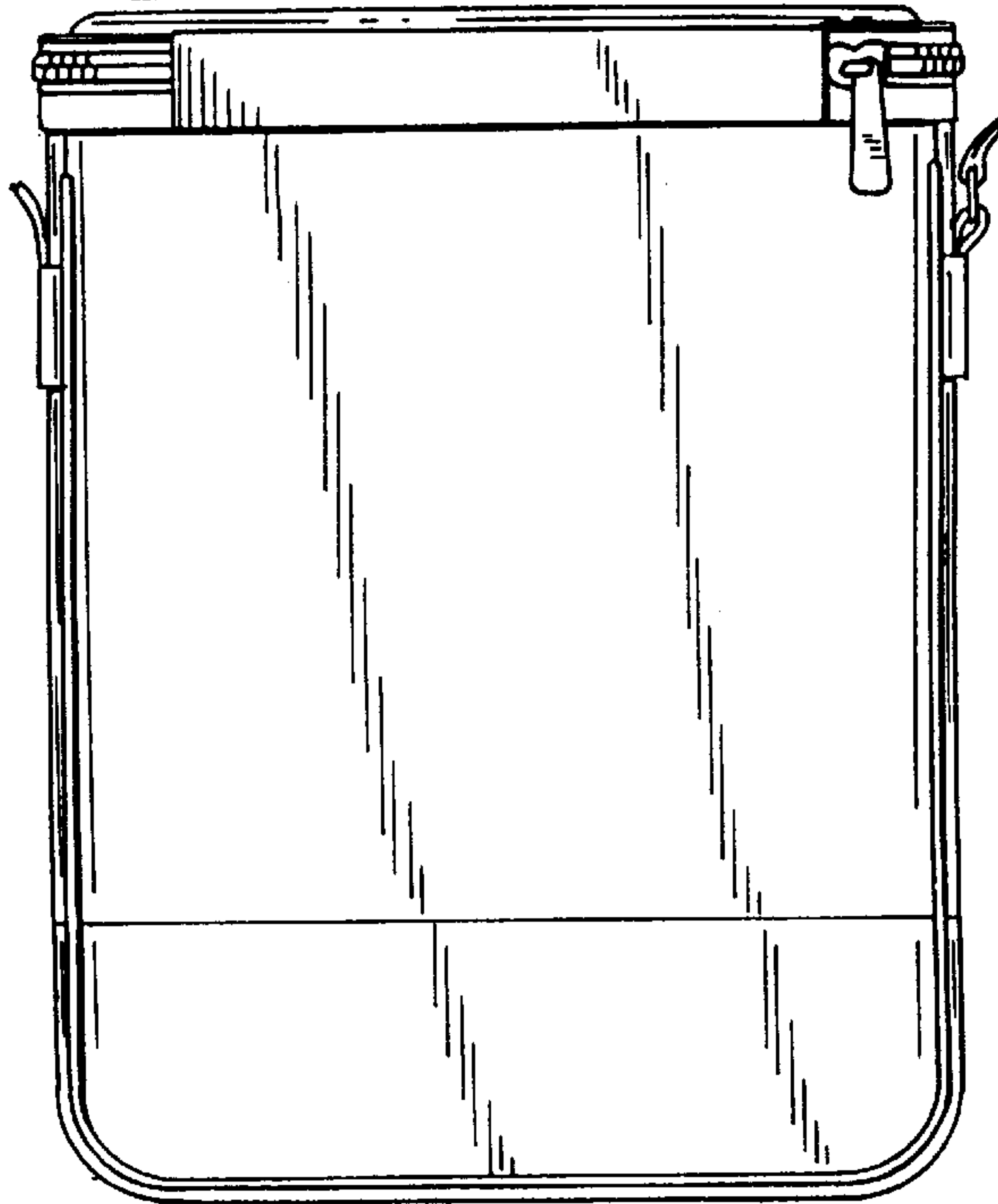

FIG. 9

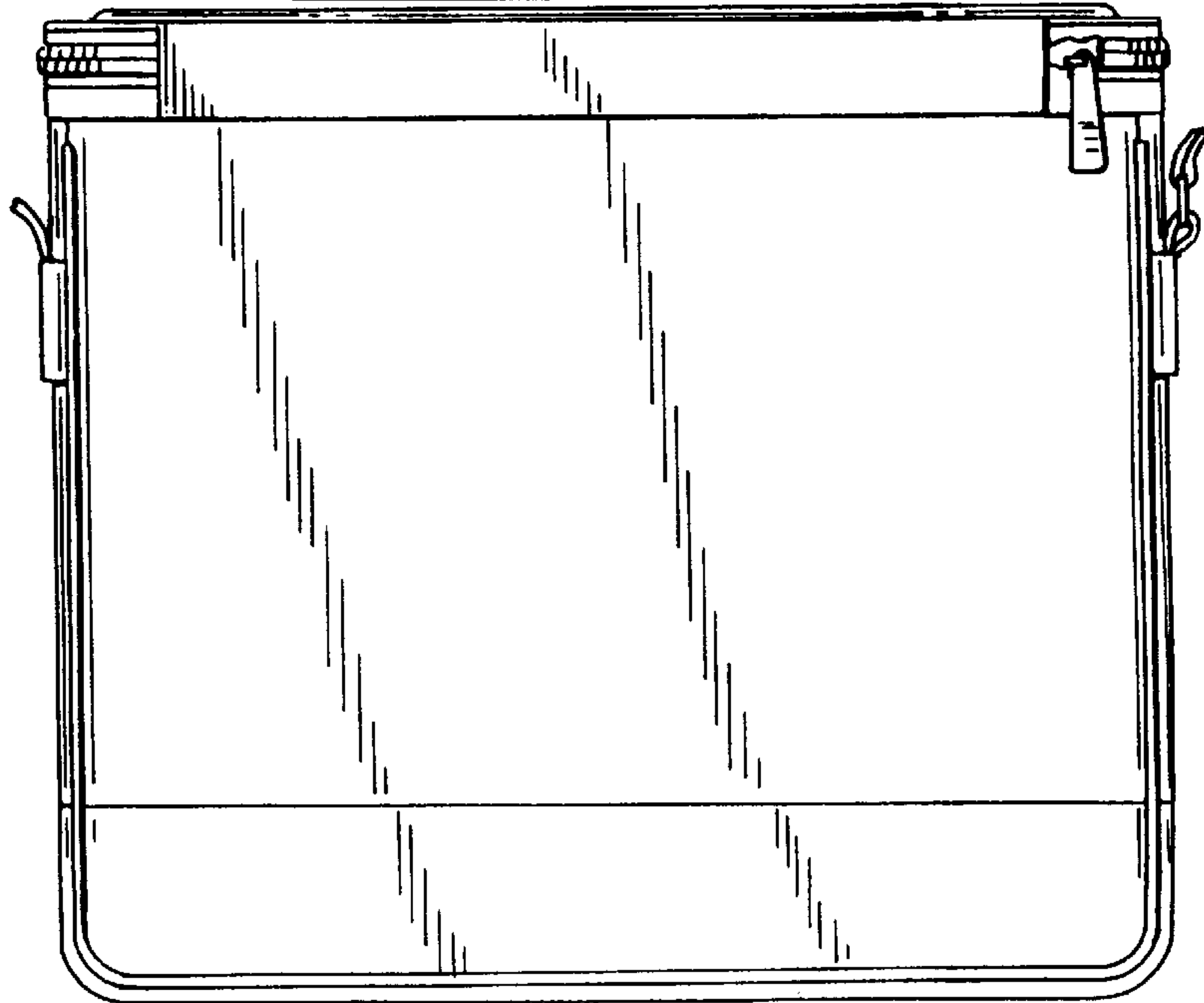

FIG. 10

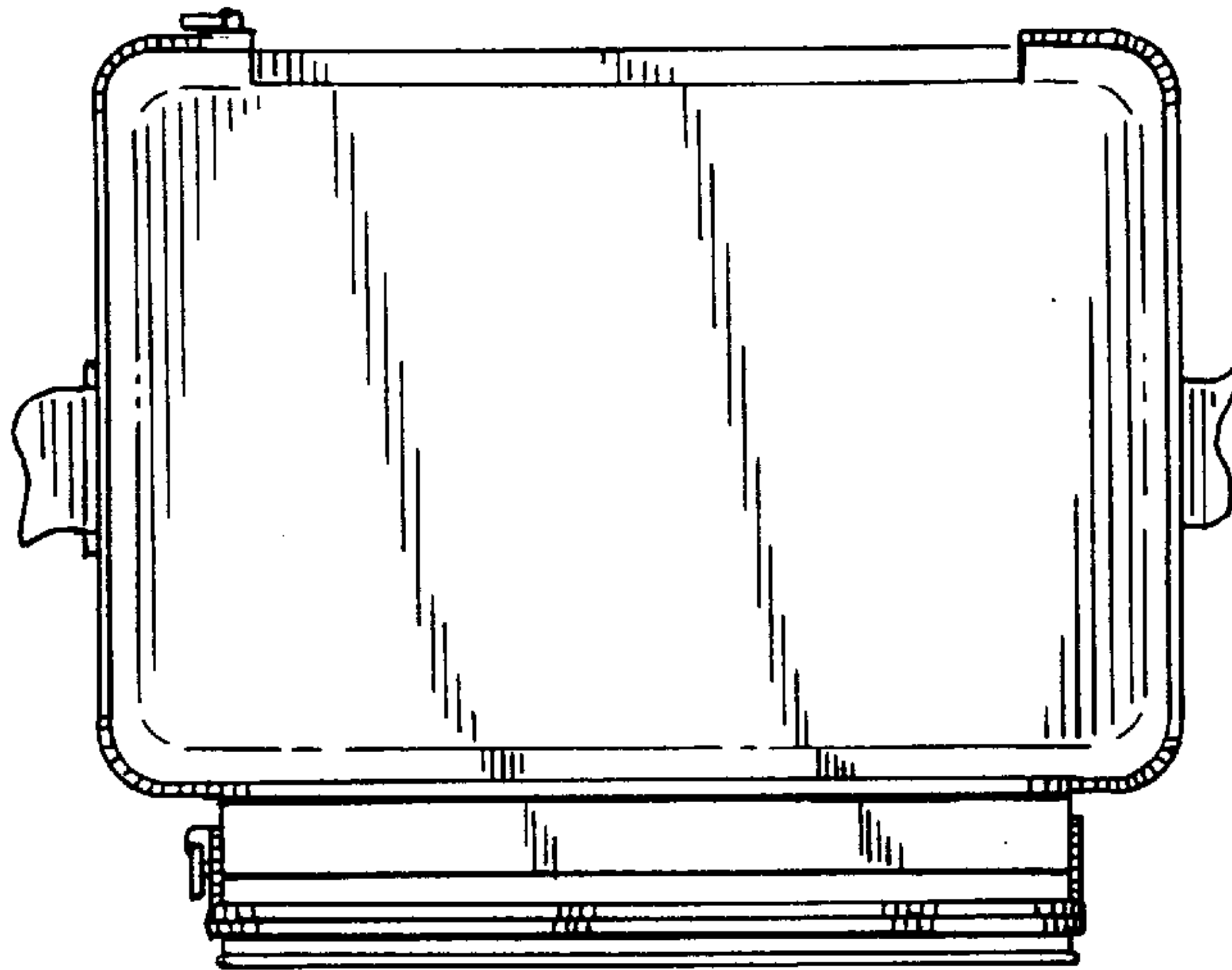

FIG. 11

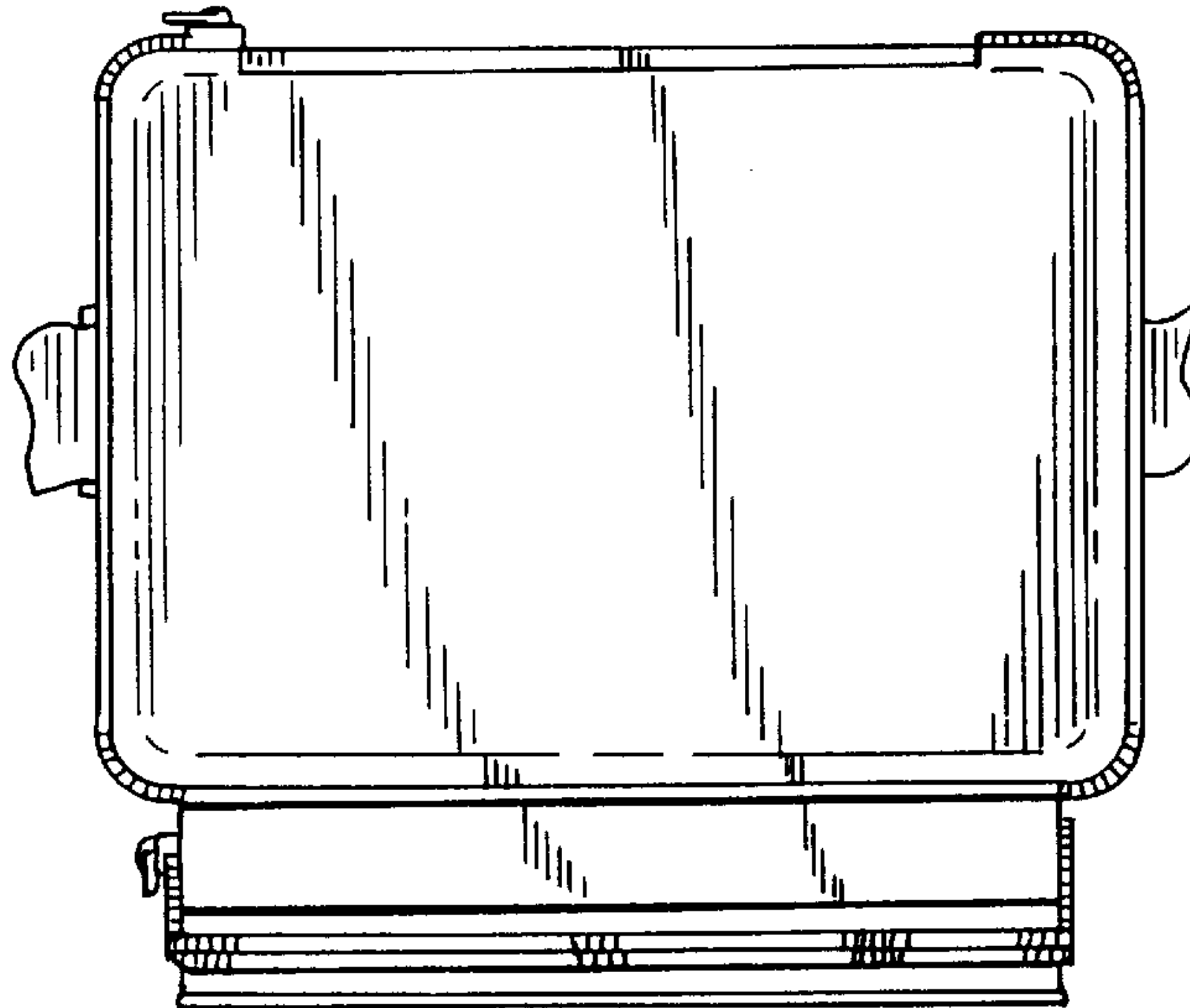

FIG. 12

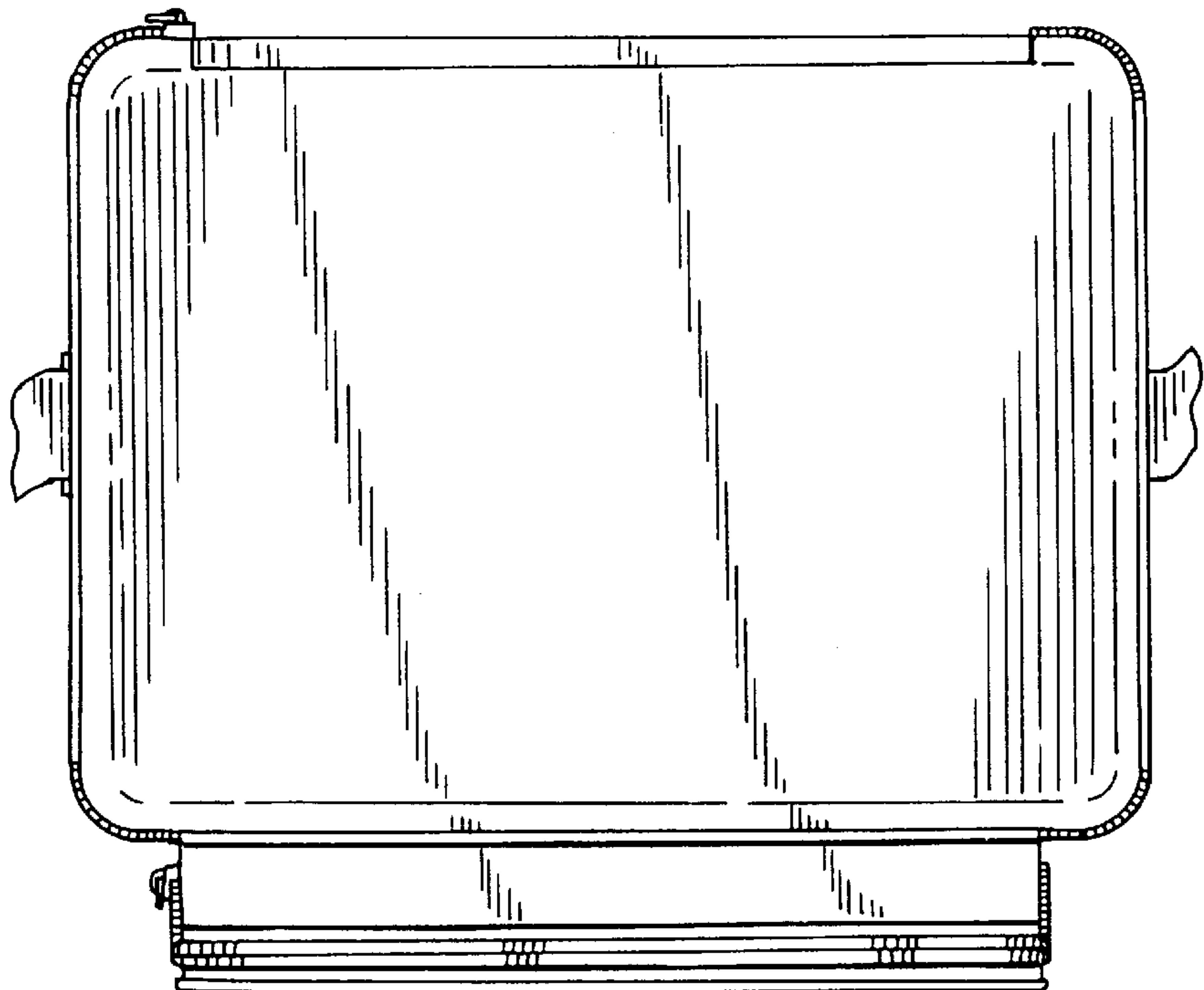

FIG. 13

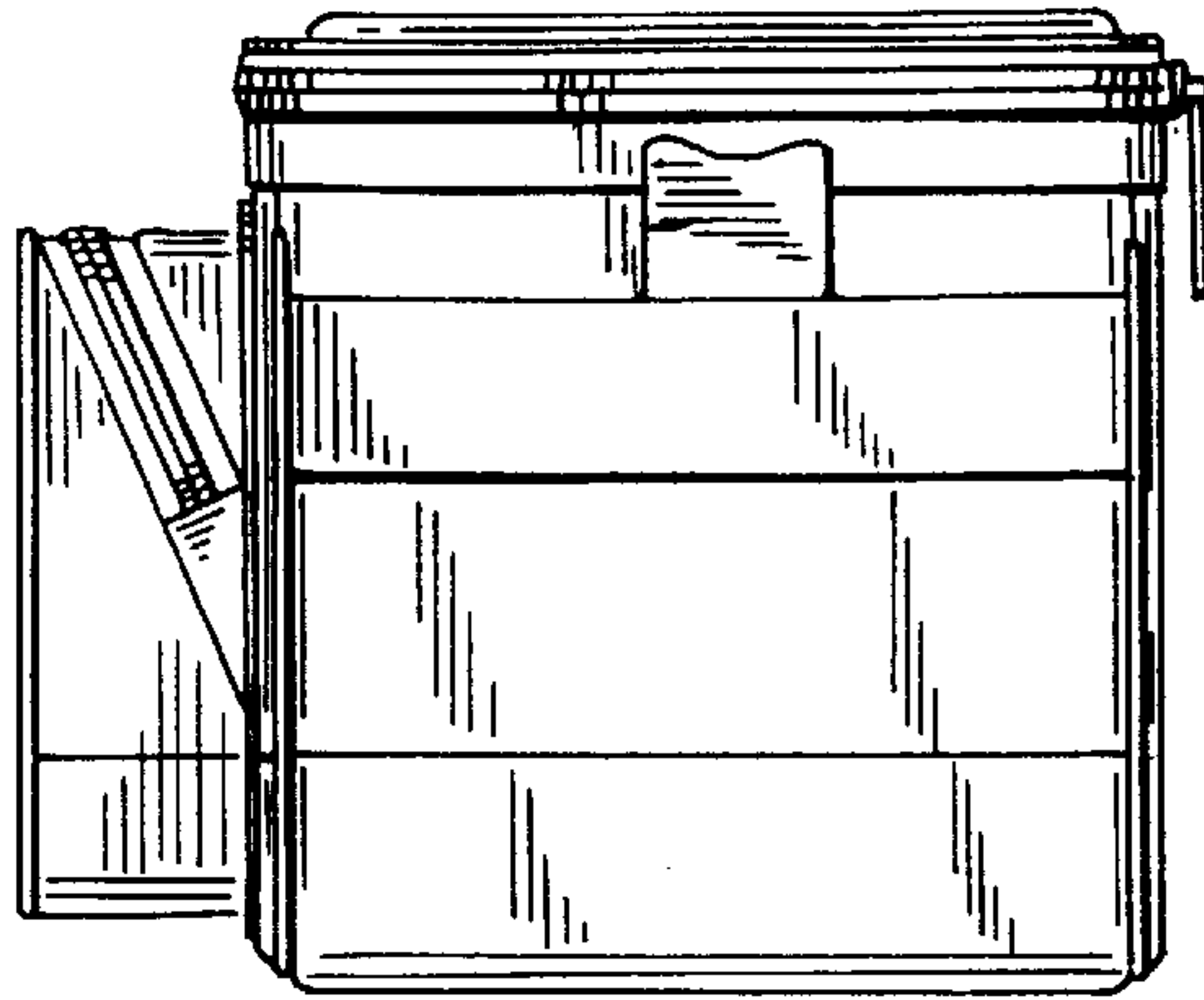

FIG. 14

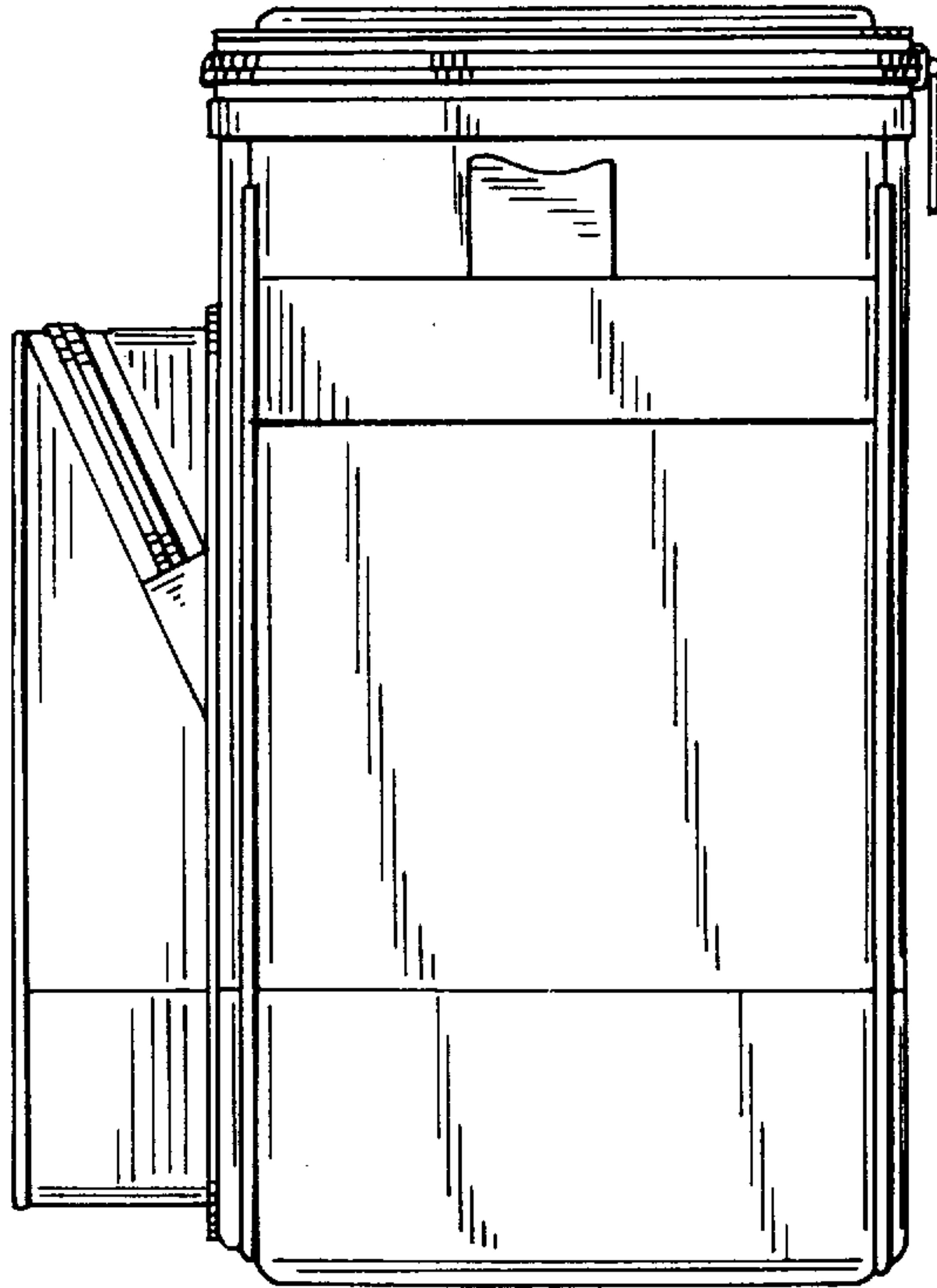

FIG. 15

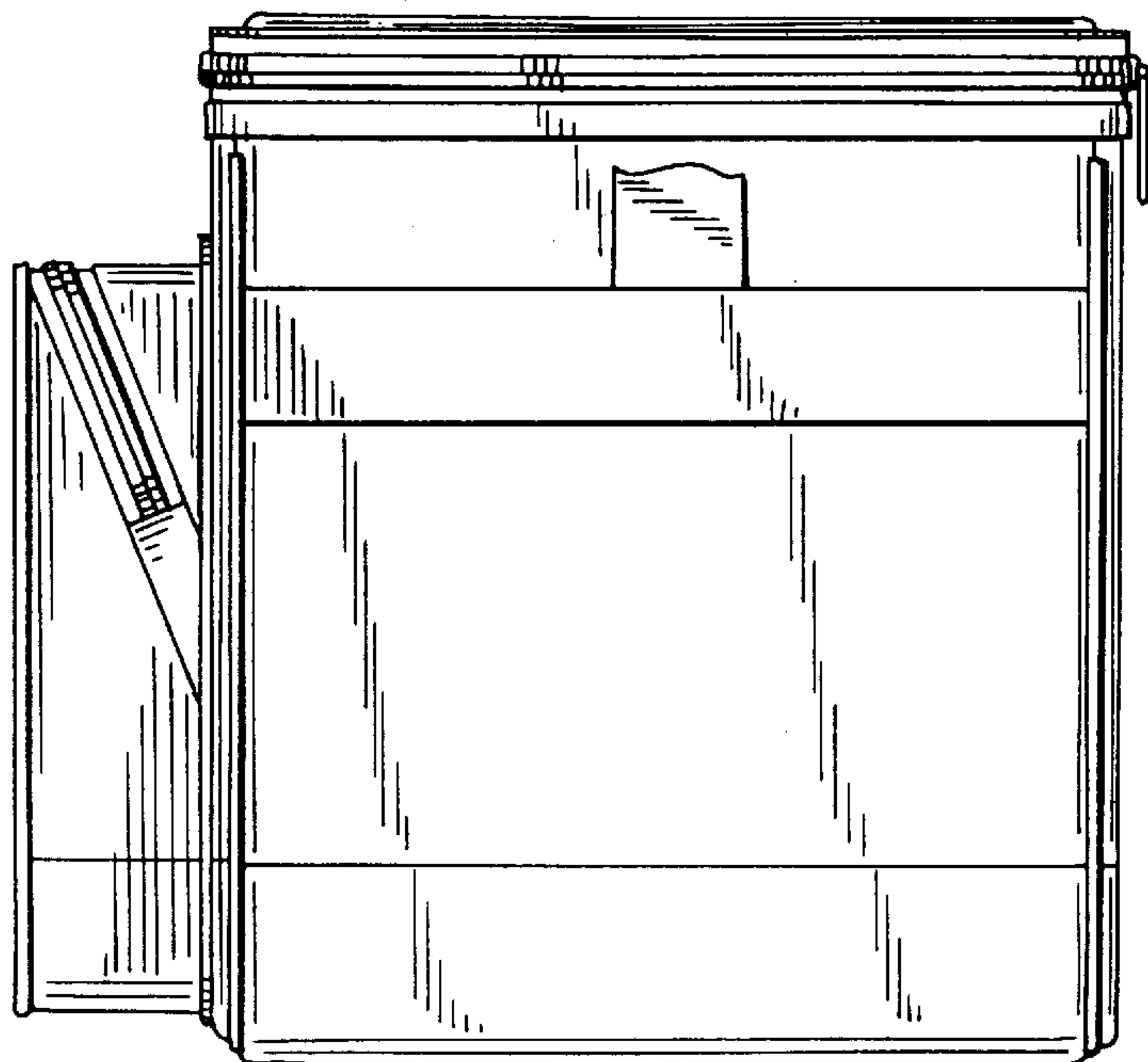

FIG. 16

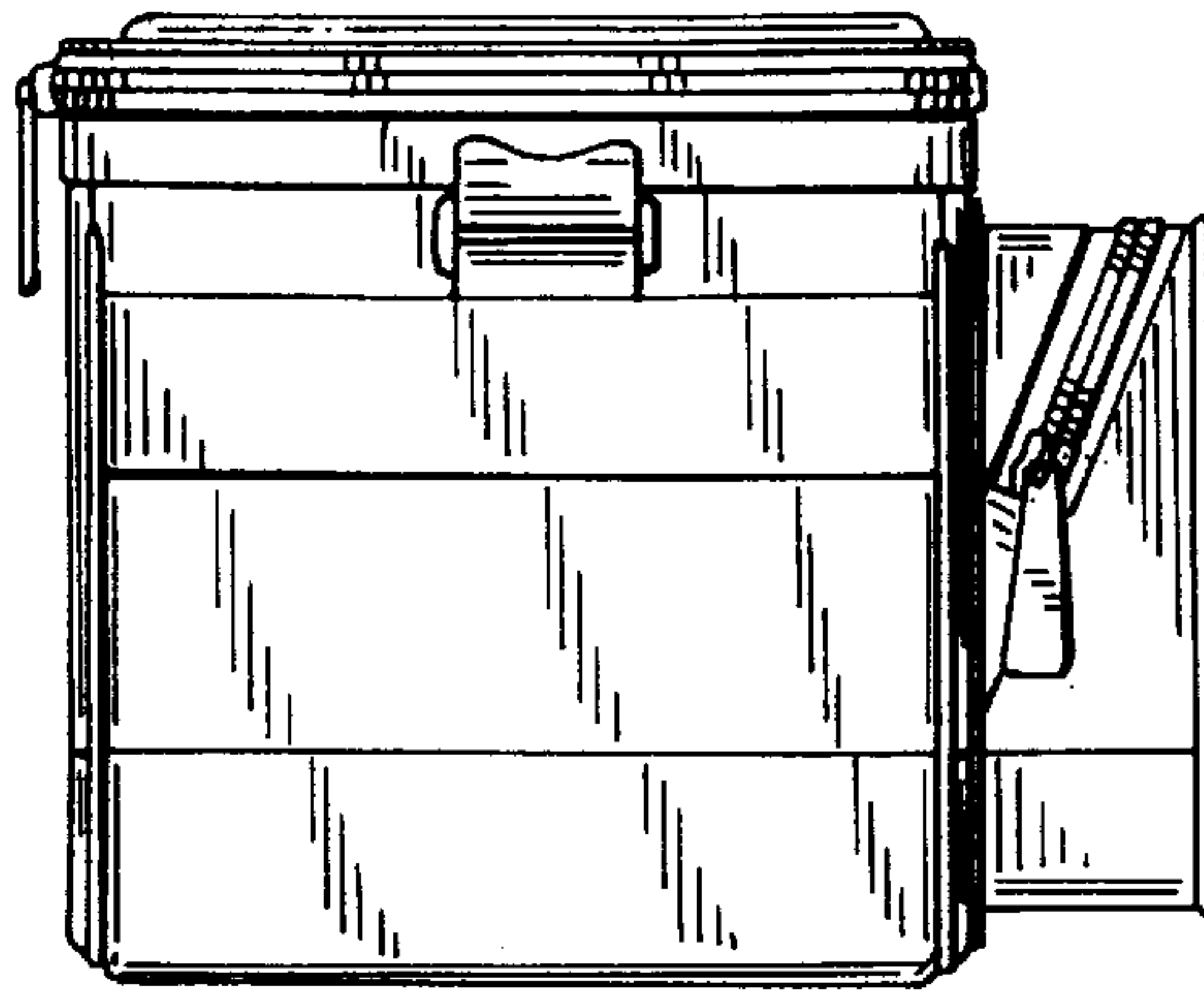

FIG. 17

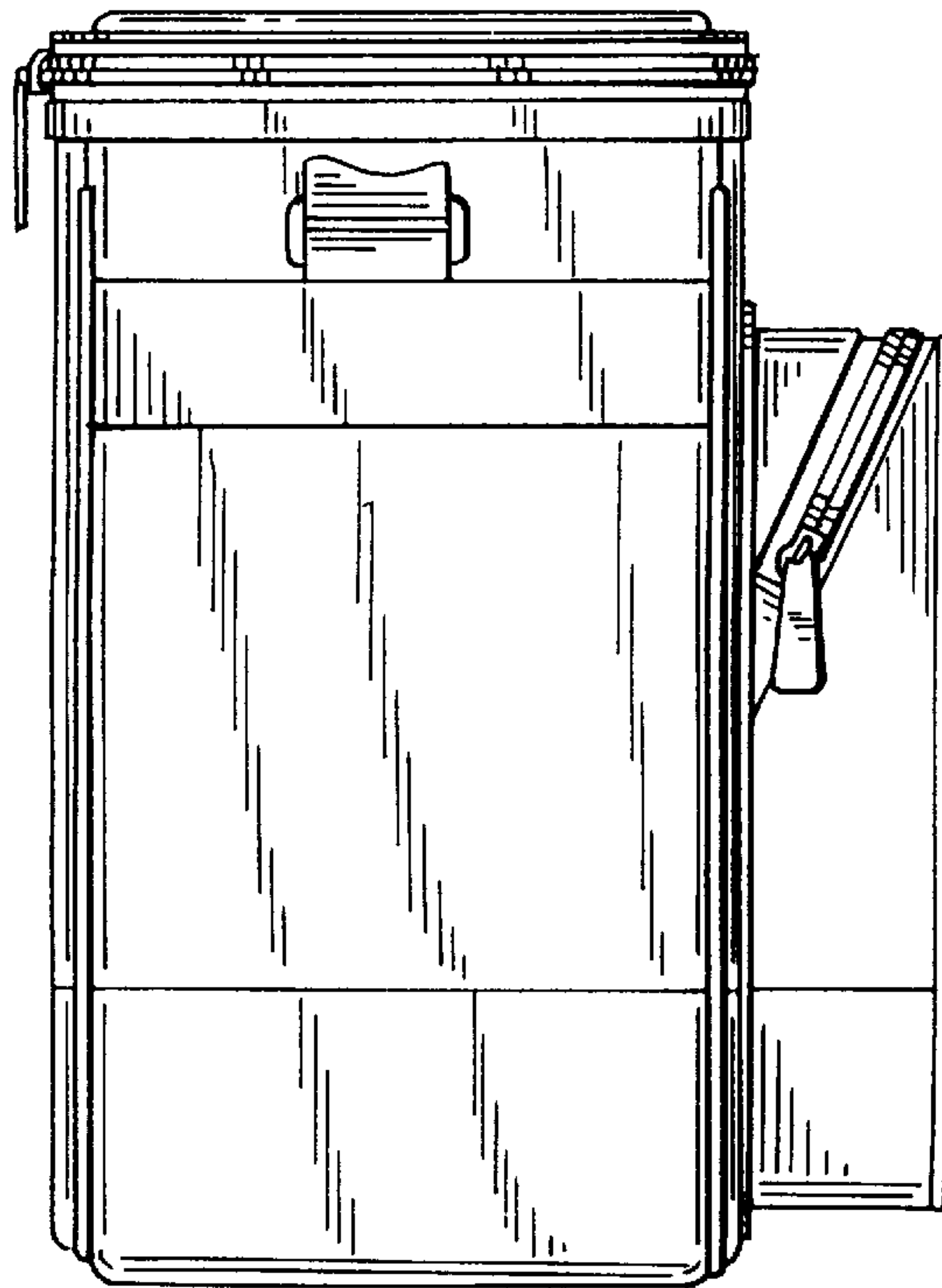

FIG. 18

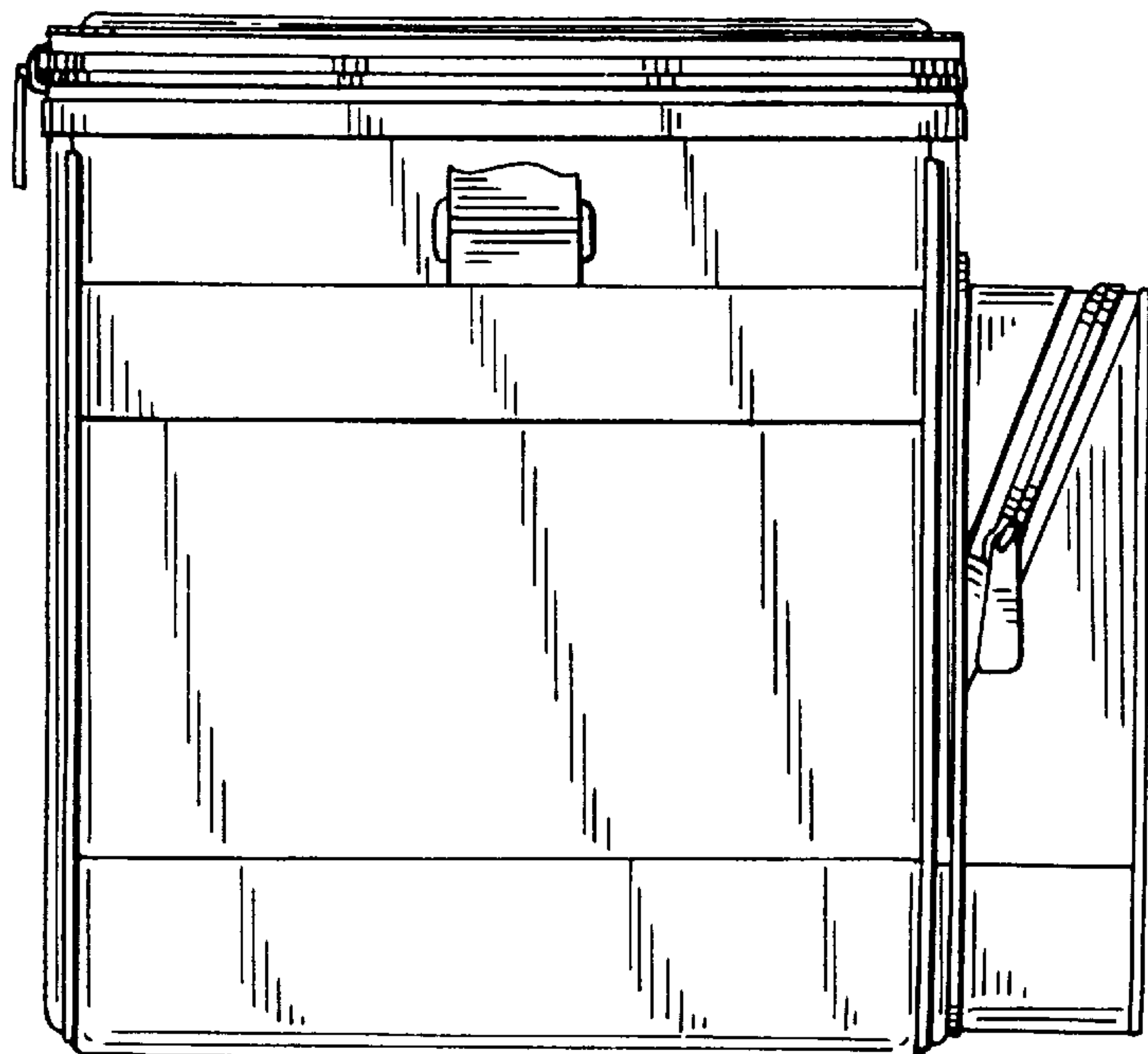

FIG. 19

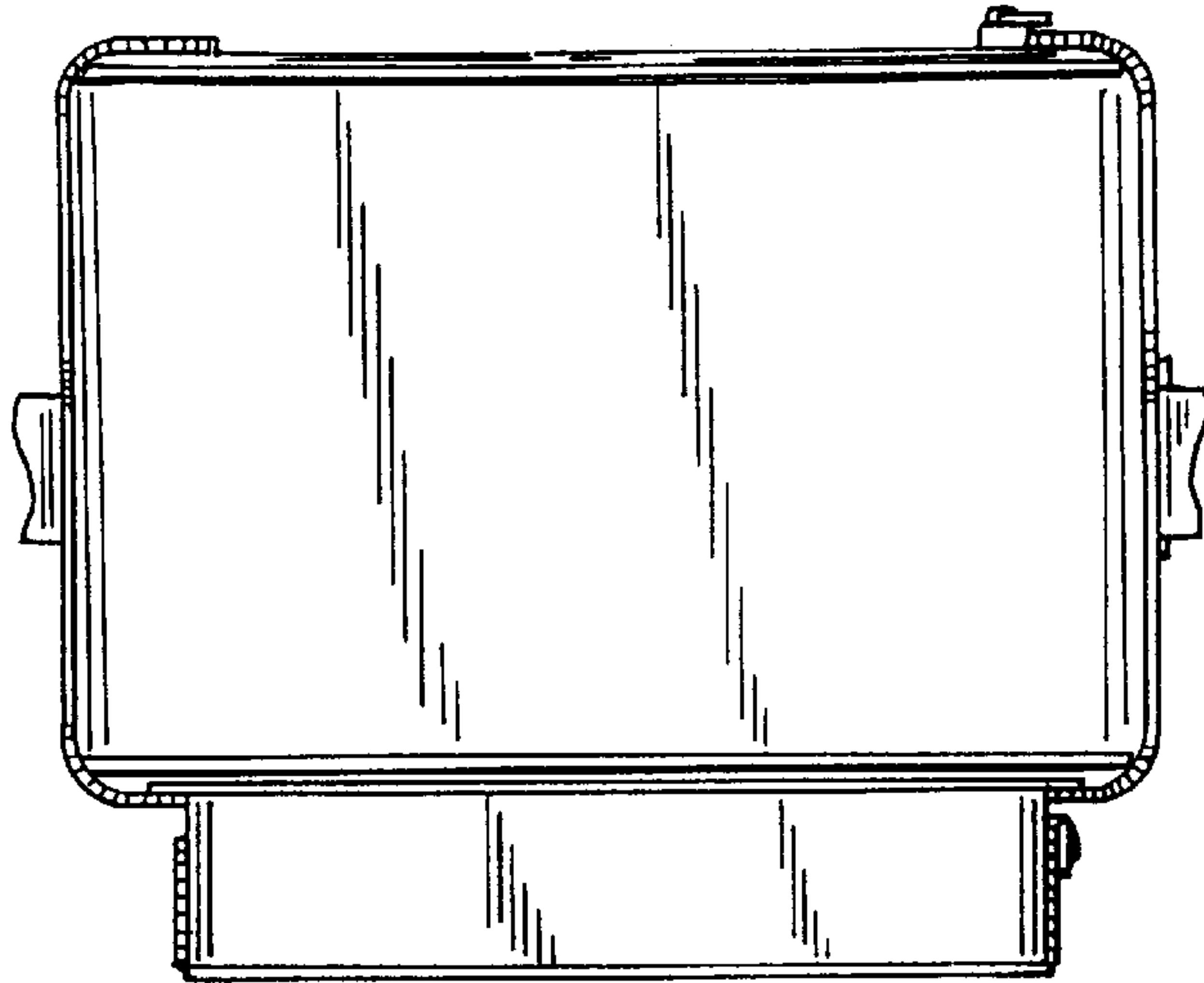

FIG. 20

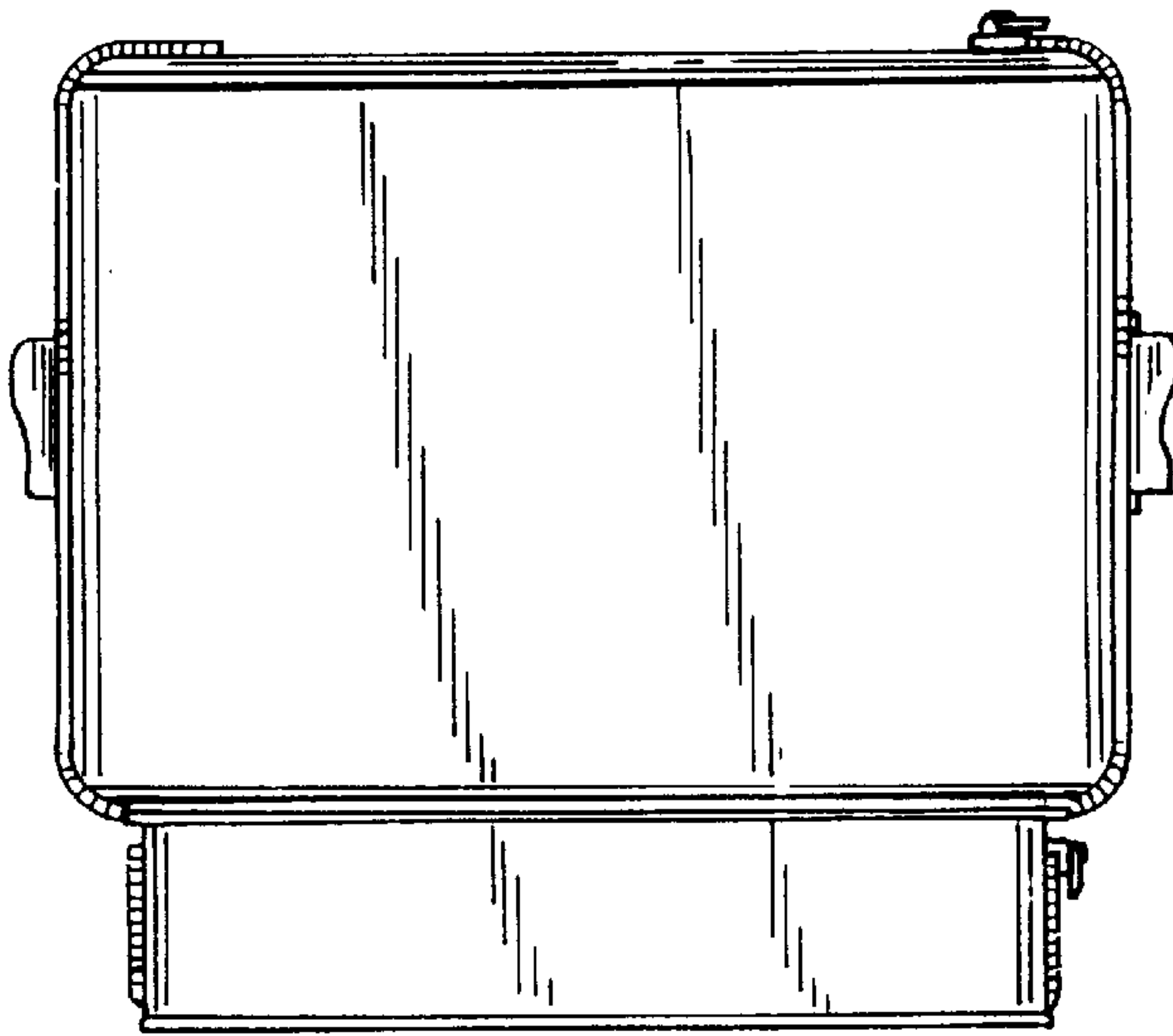

FIG. 21

