



US00D398046S

United States Patent [19]
Gillingham et al.

[11] **Patent Number: Des. 398,046**

[45] **Date of Patent: **Sep. 8, 1998**

[54] **COMBINED FILTER ELEMENT AND FRAME THEREFOR**

[75] Inventors: **Gary R. Gillingham**, Prior Lake; **Bernard A. Matthys**; **Joseph C. Tokar**, both of Apple Valley; **Daniel T. Risch**, Burnsville, all of Minn.

[73] Assignee: **Donaldson Company, Inc.**, Minneapolis, Minn.

[**] Term: **14 Years**

[21] Appl. No.: **53,682**

[22] Filed: **Apr. 26, 1996**

[51] **LOC (6) Cl.** **23-04**

[52] **U.S. Cl.** **D23/365**

[58] **Field of Search** D23/365; 55/498, 55/508; 210/483, 497.01

[56] **References Cited**

U.S. PATENT DOCUMENTS

3,807,150	4/1974	Maracle .	
3,878,594	4/1975	Minor, Jr. et al. .	
3,966,646	6/1976	Noakes et al. .	
4,289,513	9/1981	Brownhill et al. .	
4,322,231	3/1982	Hilzendegen et al.	55/498
4,410,427	10/1983	Wydevan .	
4,430,223	2/1984	Miyakawa et al. .	
4,439,321	3/1984	Taki et al. .	
4,589,983	5/1986	Wydevan .	
5,102,436	4/1992	Grabowski	55/498
5,304,351	4/1994	Tanaka et al.	55/498

Primary Examiner—Lisa Lichtenstein
Attorney, Agent, or Firm—Merchant, Gould, Smith, Edell, Welter & Schmidt

[57] **CLAIM**

The ornamental design for a combined filter element and frame therefor, as shown and described.

DESCRIPTION

FIG. 1 shows a perspective view of a first embodiment of a filter apparatus, according to the present invention; FIG. 2 shows a top plan view thereof, a bottom plan view not being shown as it is a mirror image of the top plan view; FIG. 3 shows a front elevational view thereof, a rear elevational view not being shown as it is a mirror image of the front elevational view; FIG. 4 shows a right side elevational view thereof, a left side elevational view not being shown as it is a mirror image of the right side elevational view; FIG. 5 shows a perspective view of a second embodiment of a filter apparatus, according to the principles of the present invention; FIG. 6 shows a top plan view thereof, a bottom plan view not being shown as it is a mirror image of the top plan view; FIG. 7 shows a front elevational view thereof, a rear elevational view not being shown as it is a mirror image of the front elevational view; and, FIG. 8 shows a right side elevational view thereof, a left side elevational view not being shown as it is a mirror image of the right side elevational view.

1 Claim, 4 Drawing Sheets

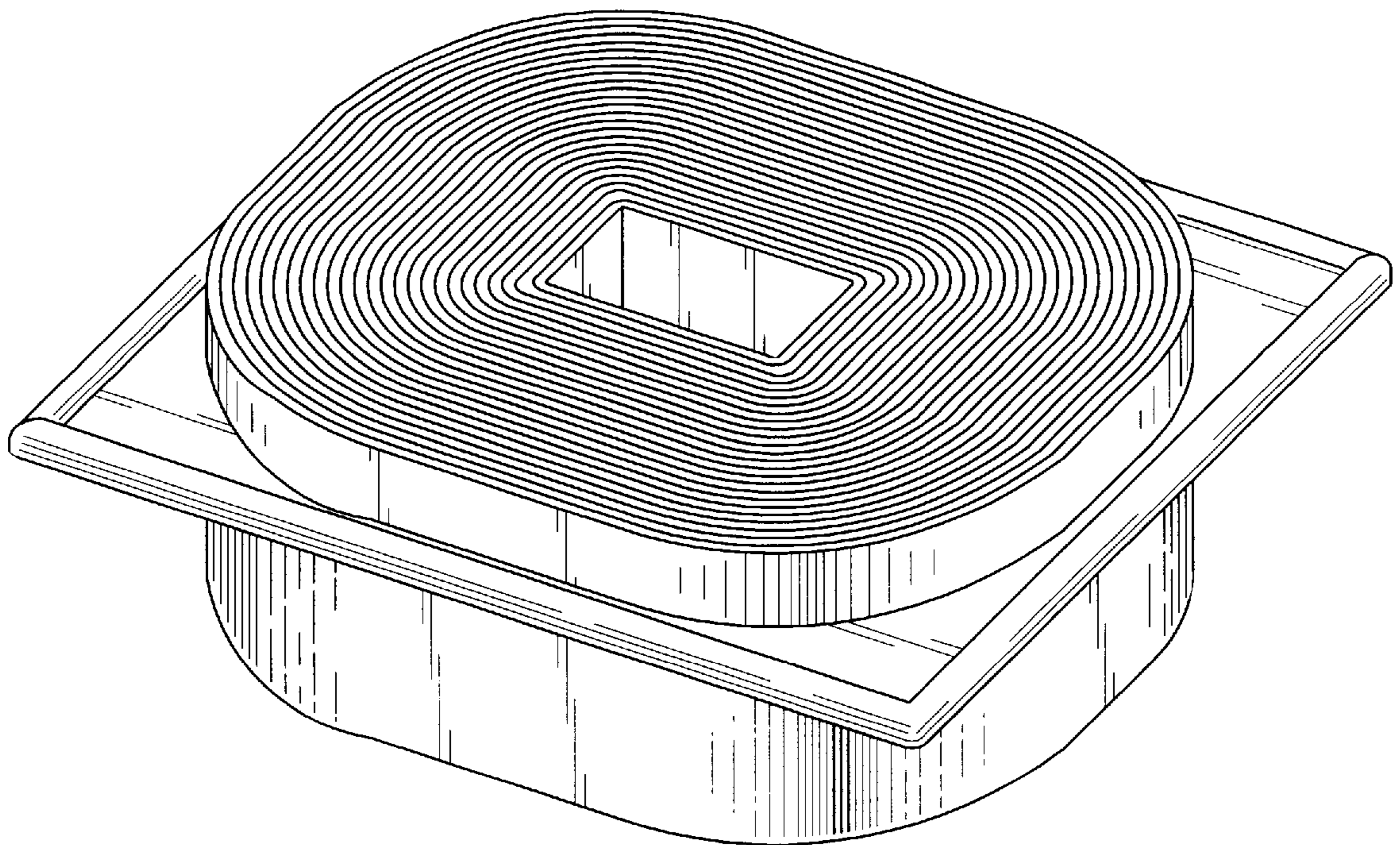

FIG. 1

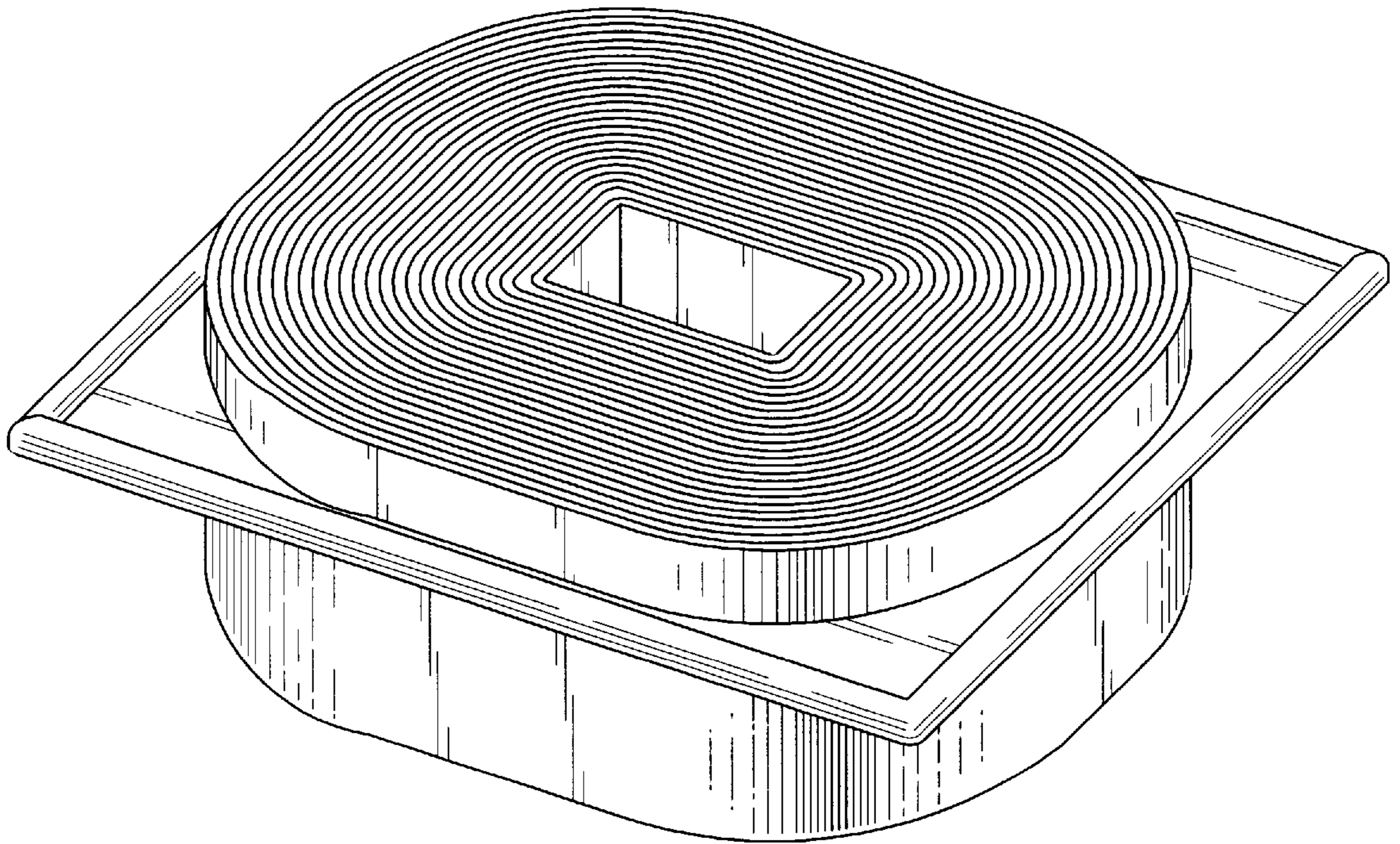
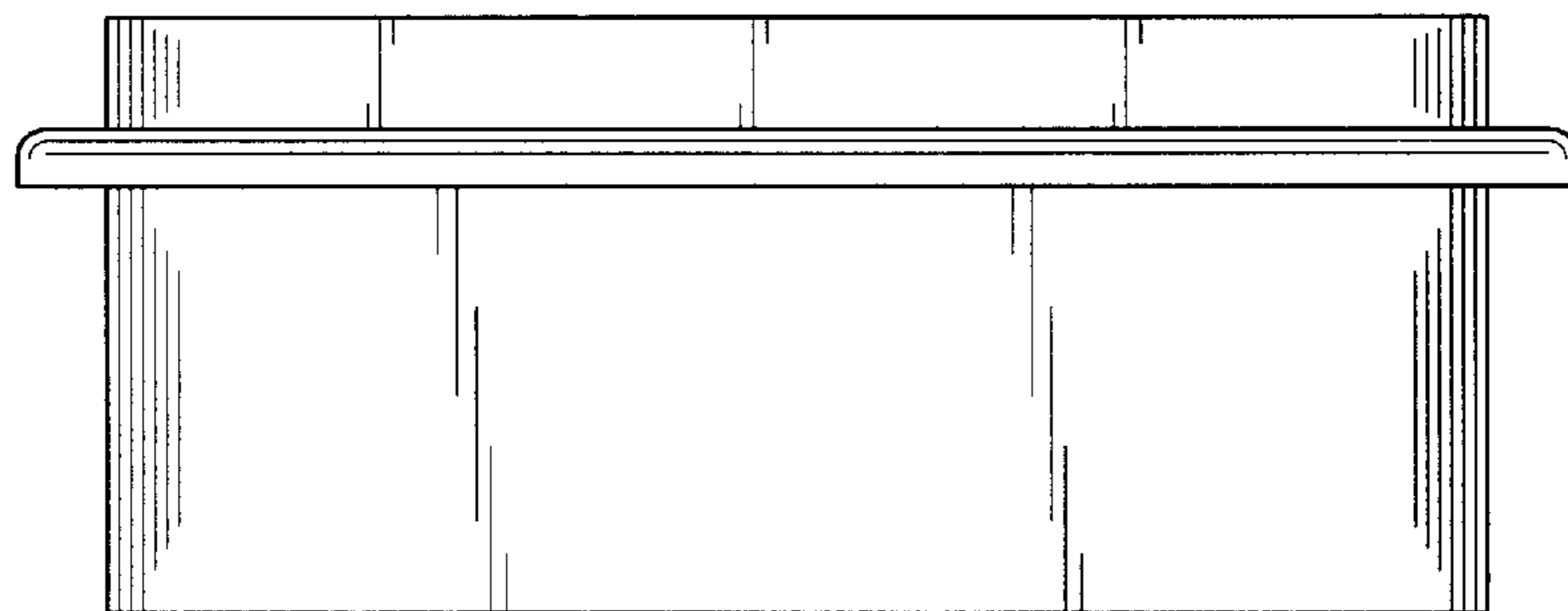

FIG. 3



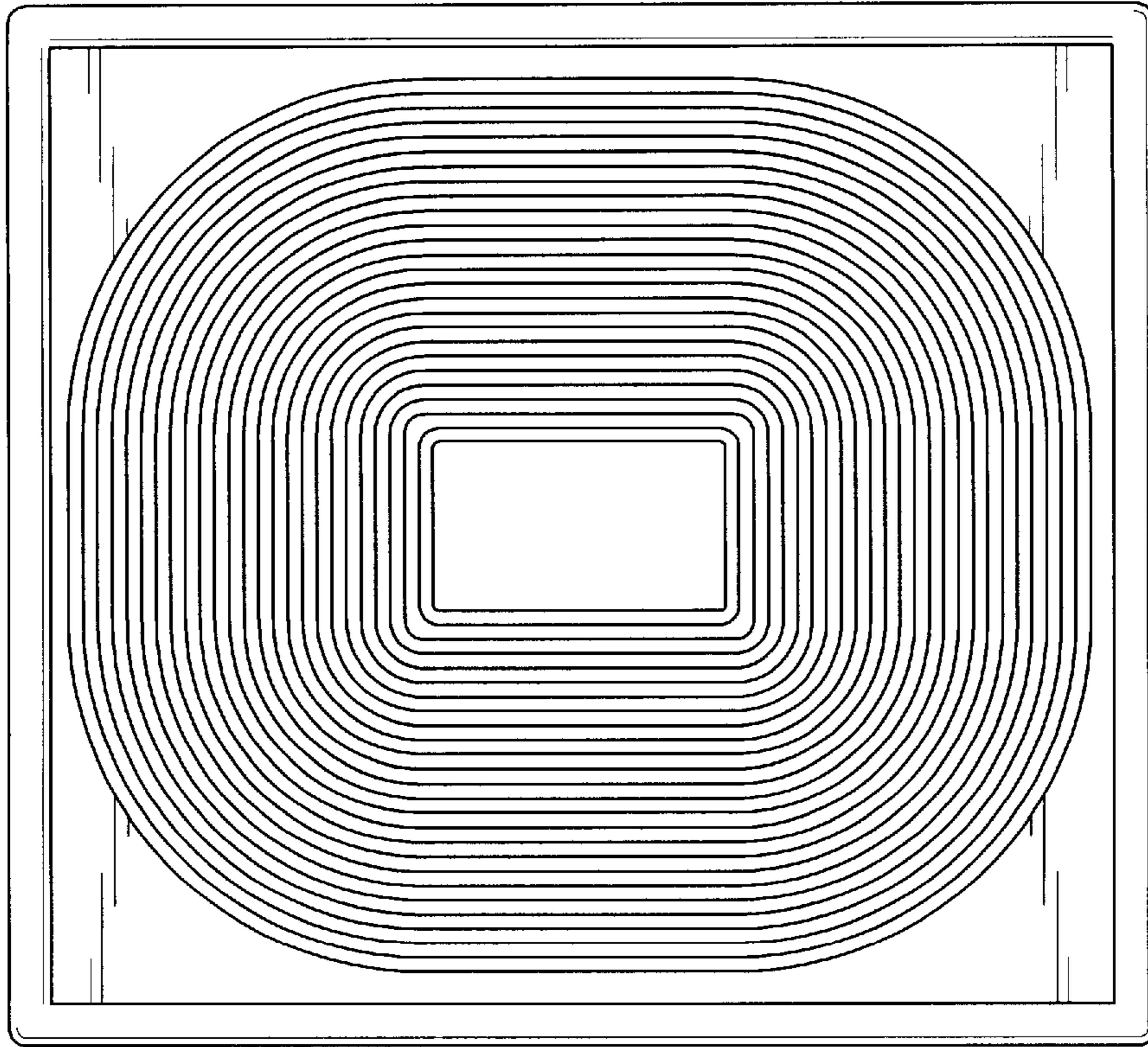

FIG. 2

FIG. 4

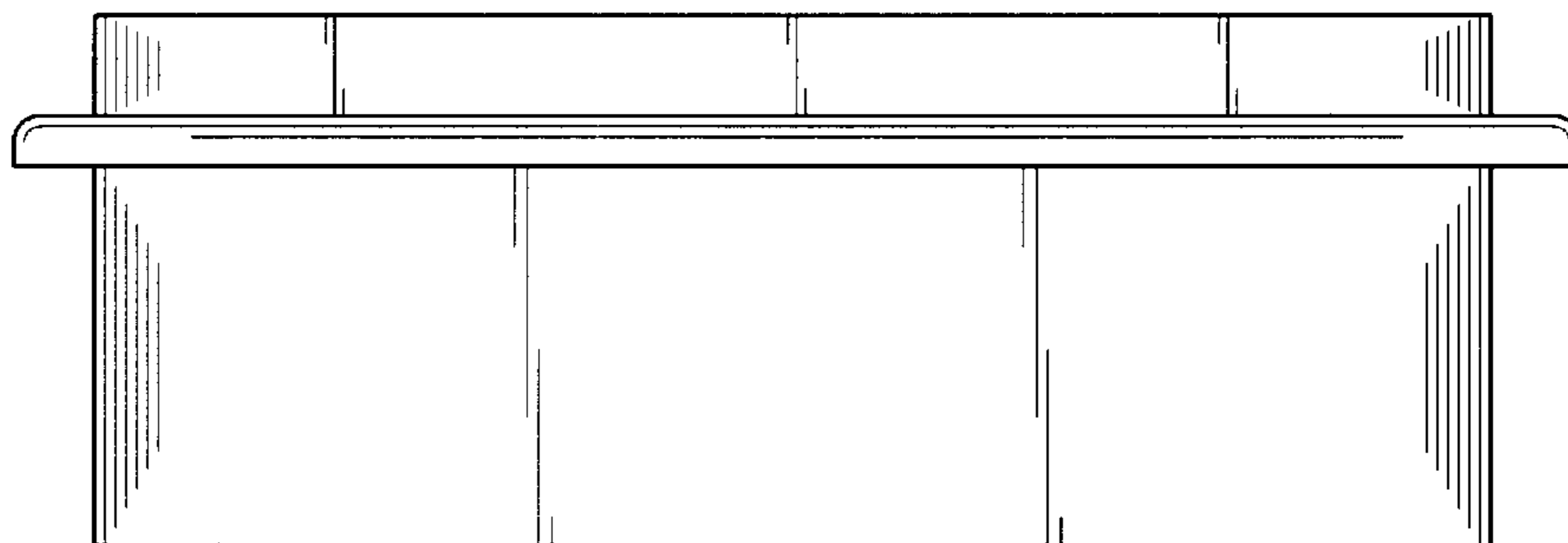

FIG. 5

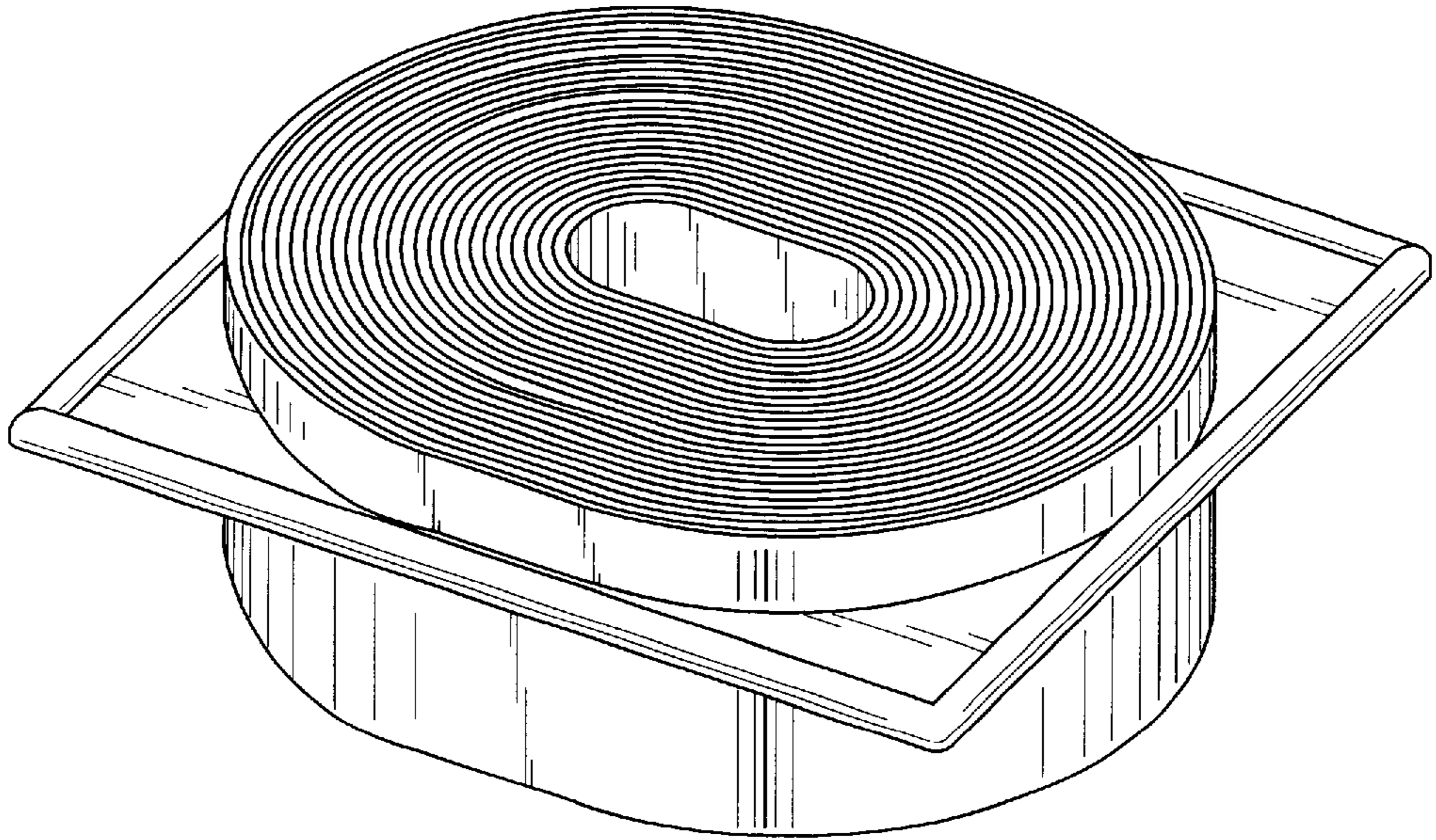

FIG. 7

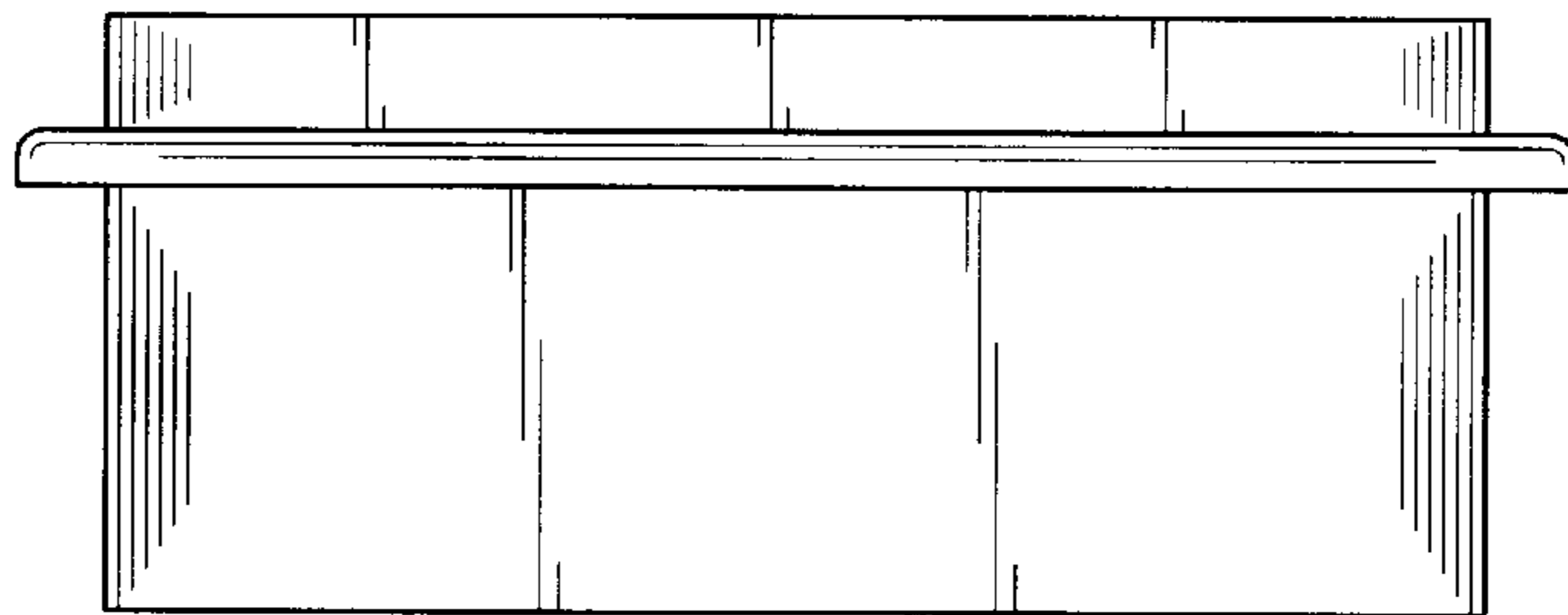

FIG. 6

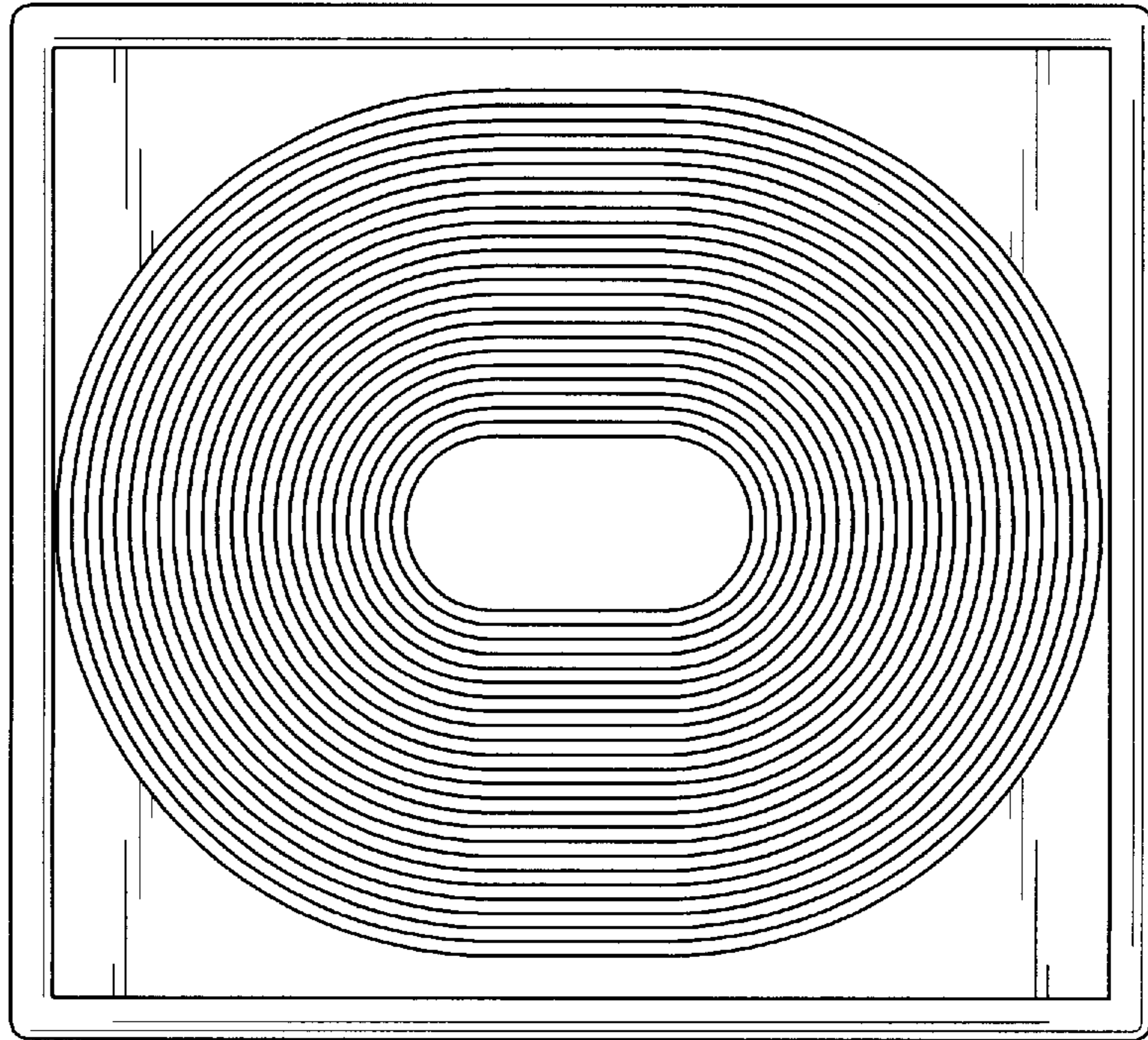

FIG. 8

