



US00D398029S

United States Patent [19]

Falls et al.

[11] **Patent Number:** **Des. 398,029**

[45] **Date of Patent:** ****Sep. 8, 1998**

[54] **SHELF BACKPLANE**

[75] Inventors: **S. Douglas Falls**, Oakbrook Terrace, Ill.; **Ernest J. Dale**, Waterford, Va.; **Richard Buehler**, Arnold; **Norman Wildberger**, Glenn Dale, both of Md.

[73] Assignee: **Intelledge Corporation**, Lombard, Ill.

[**] Term: **14 Years**

[21] Appl. No.: **57,778**

[22] Filed: **Jul. 31, 1996**

[51] **LOC (6) Cl.** **20-02**

[52] **U.S. Cl.** **D20/44; D25/119**

[58] **Field of Search** D20/10, 42, 43, D20/44; D25/119, 122, 121, 124; 40/584, 649, 124.01, 654.01, 653, 661; 52/522; 361/680, 681

[56] **References Cited**

U.S. PATENT DOCUMENTS

D. 187,517 3/1960 Linscott D20/44

D. 190,361 5/1961 Hopp D20/44
D. 297,654 9/1988 Orsos D20/44
D. 340,532 10/1993 Jansen D25/119
2,046,121 6/1936 Hopp D20/44
4,753,026 6/1988 Woodman et al. 40/584

Primary Examiner—Susan J. Lucas
Assistant Examiner—Jennifer Rivard
Attorney, Agent, or Firm—John M. England, Jr.

[57] **CLAIM**

We claim the ornamental design for a shelf backplane, as shown and described.

DESCRIPTION

FIG. 1 is a front view;
FIG. 2 is a rear view;
FIG. 3 is a top view;
FIG. 4 is a bottom view;
FIG. 5 is a right side view;
FIG. 6 is a left side view; and,
FIG. 7 is a top right perspective view.
The claimed design is fragmentarily shown to indicate indefinite length.

1 Claim, 5 Drawing Sheets

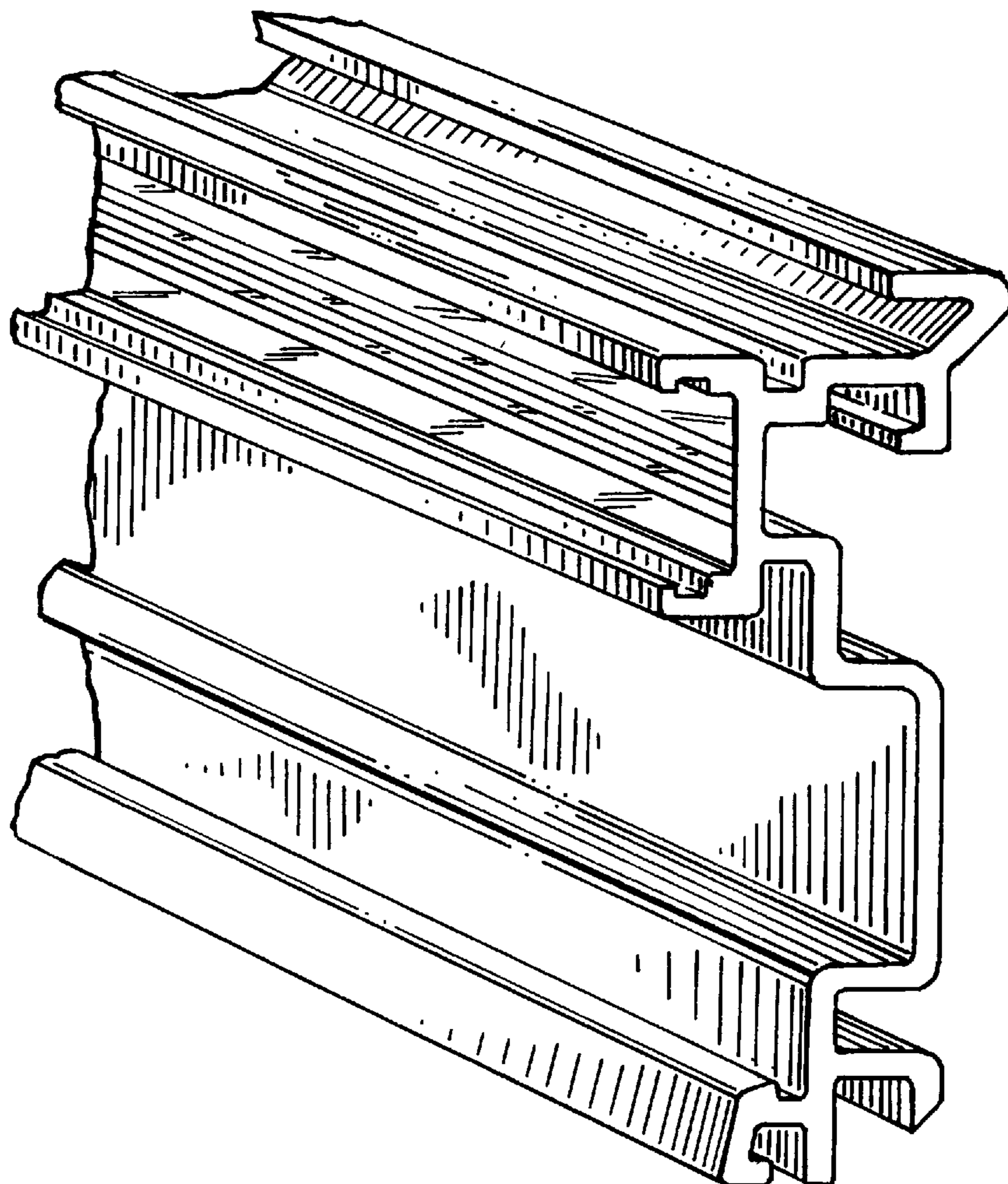

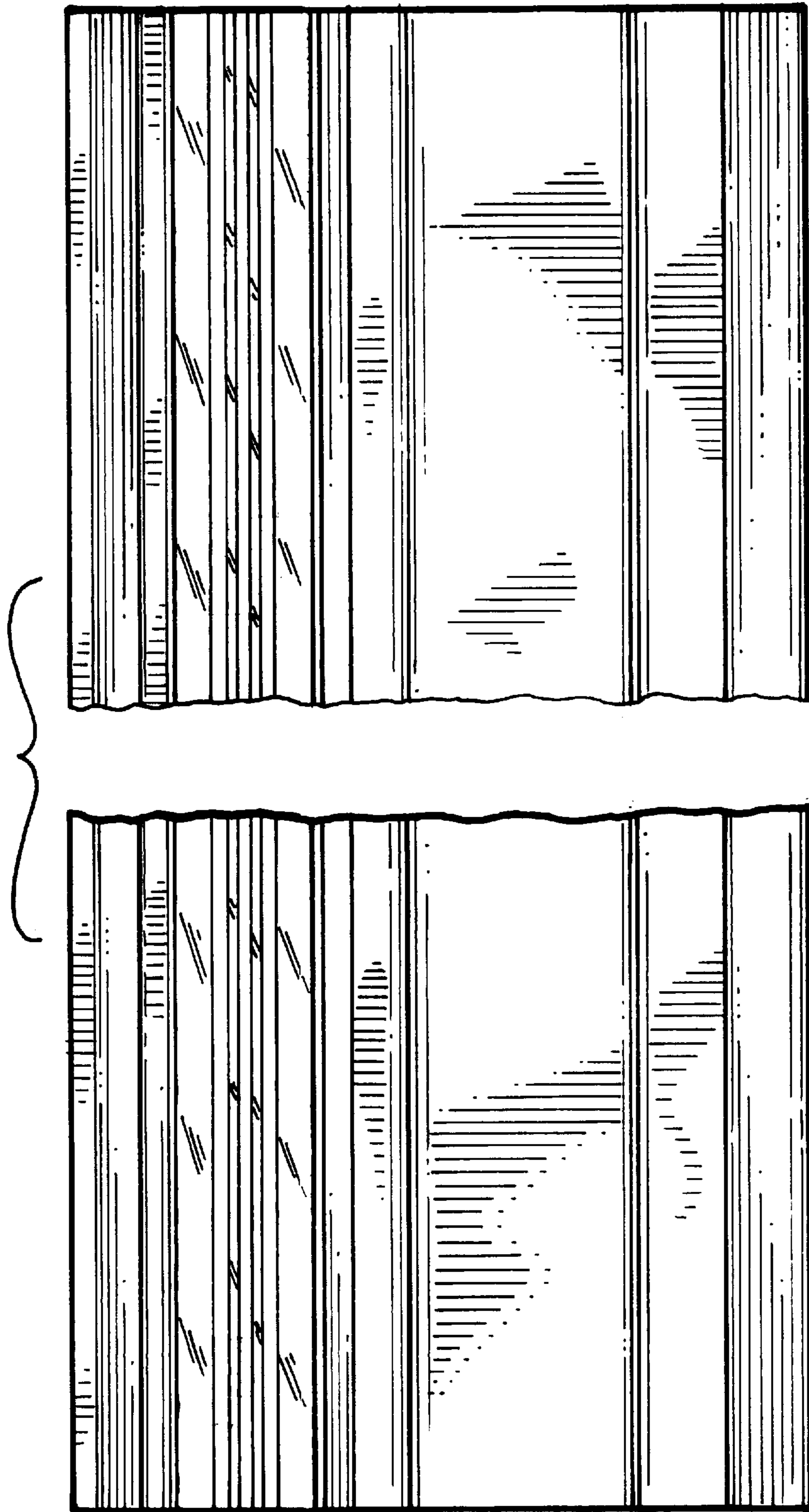

FIG. 1

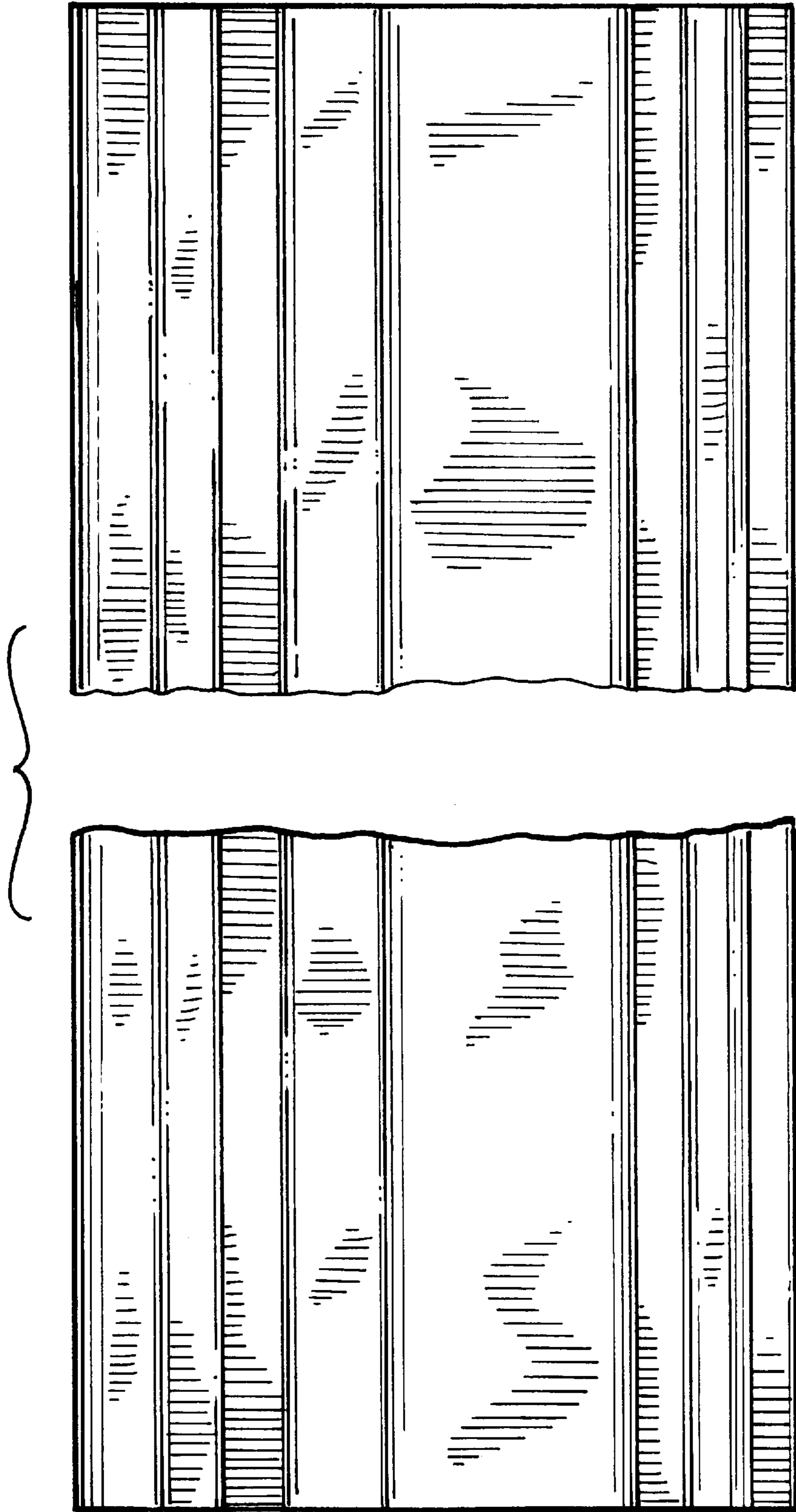

FIG. 2

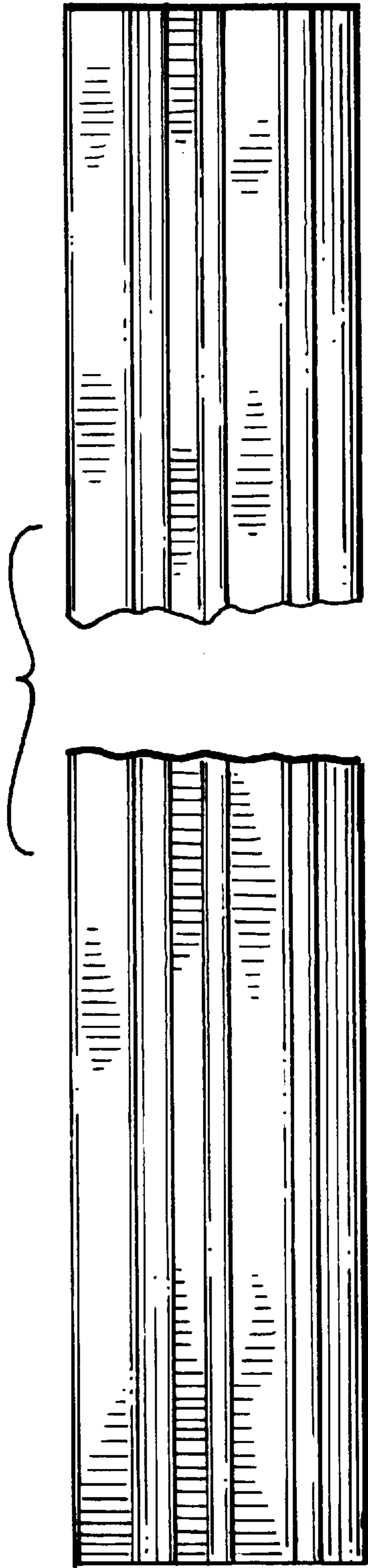

FIG. 4

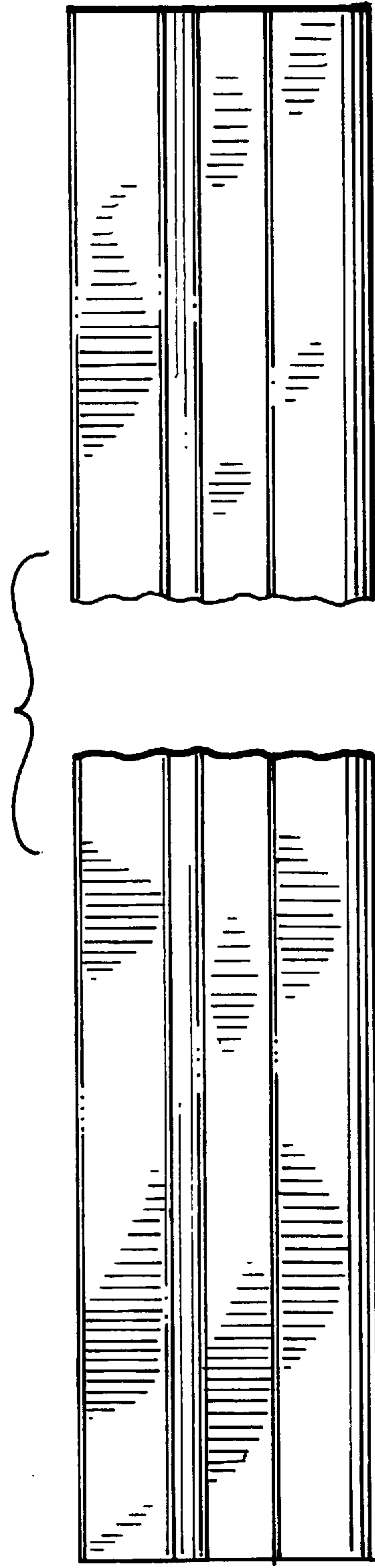

FIG. 3

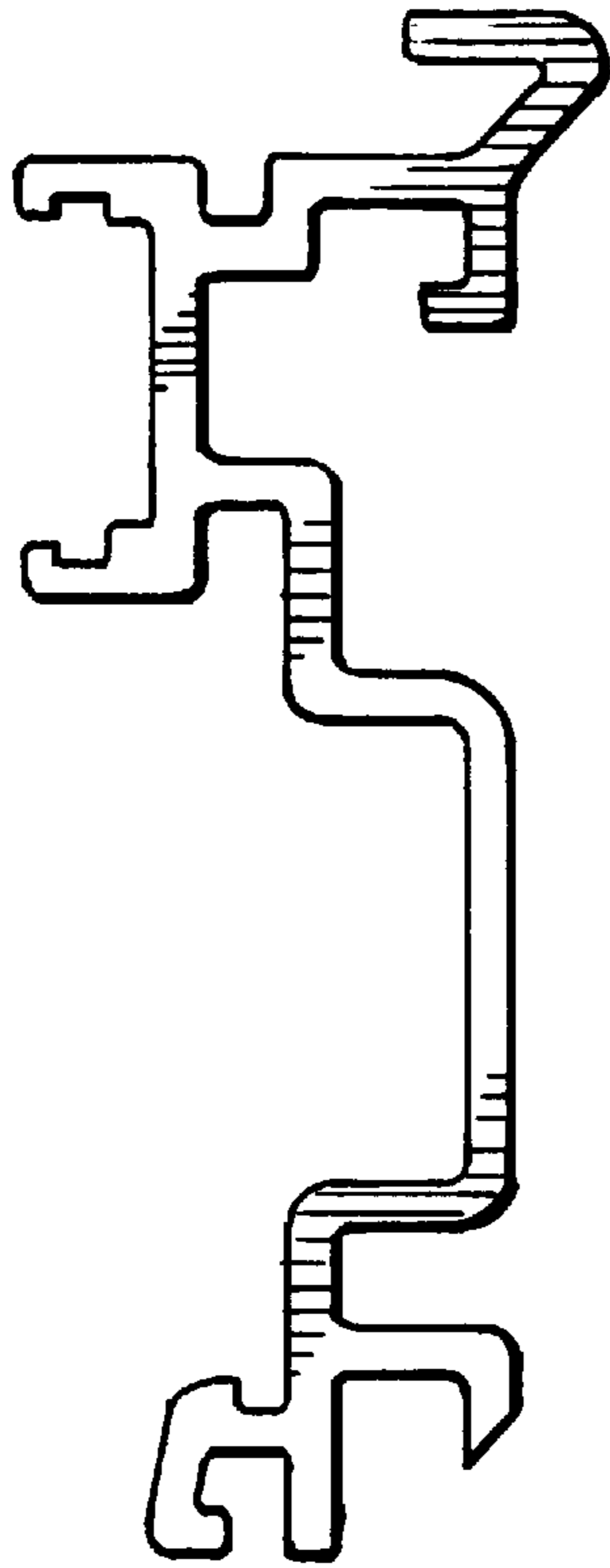

FIG. 5

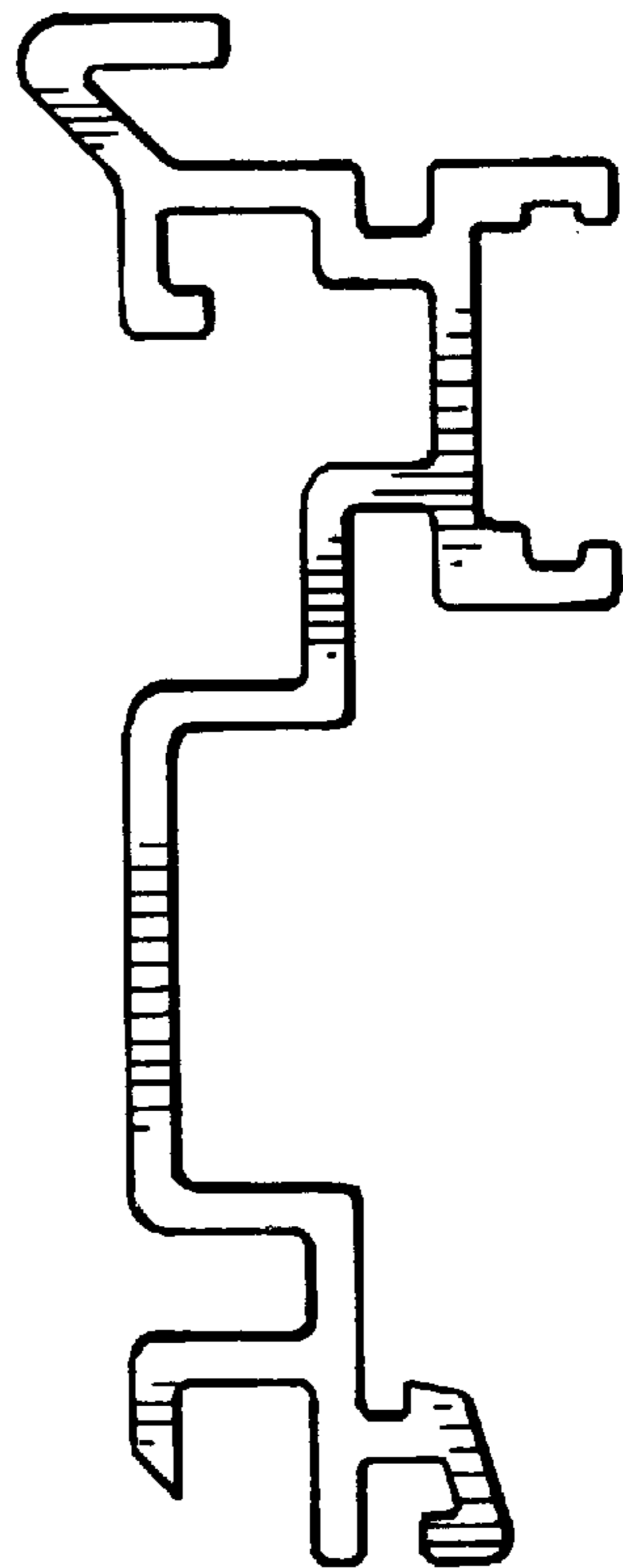

FIG. 6

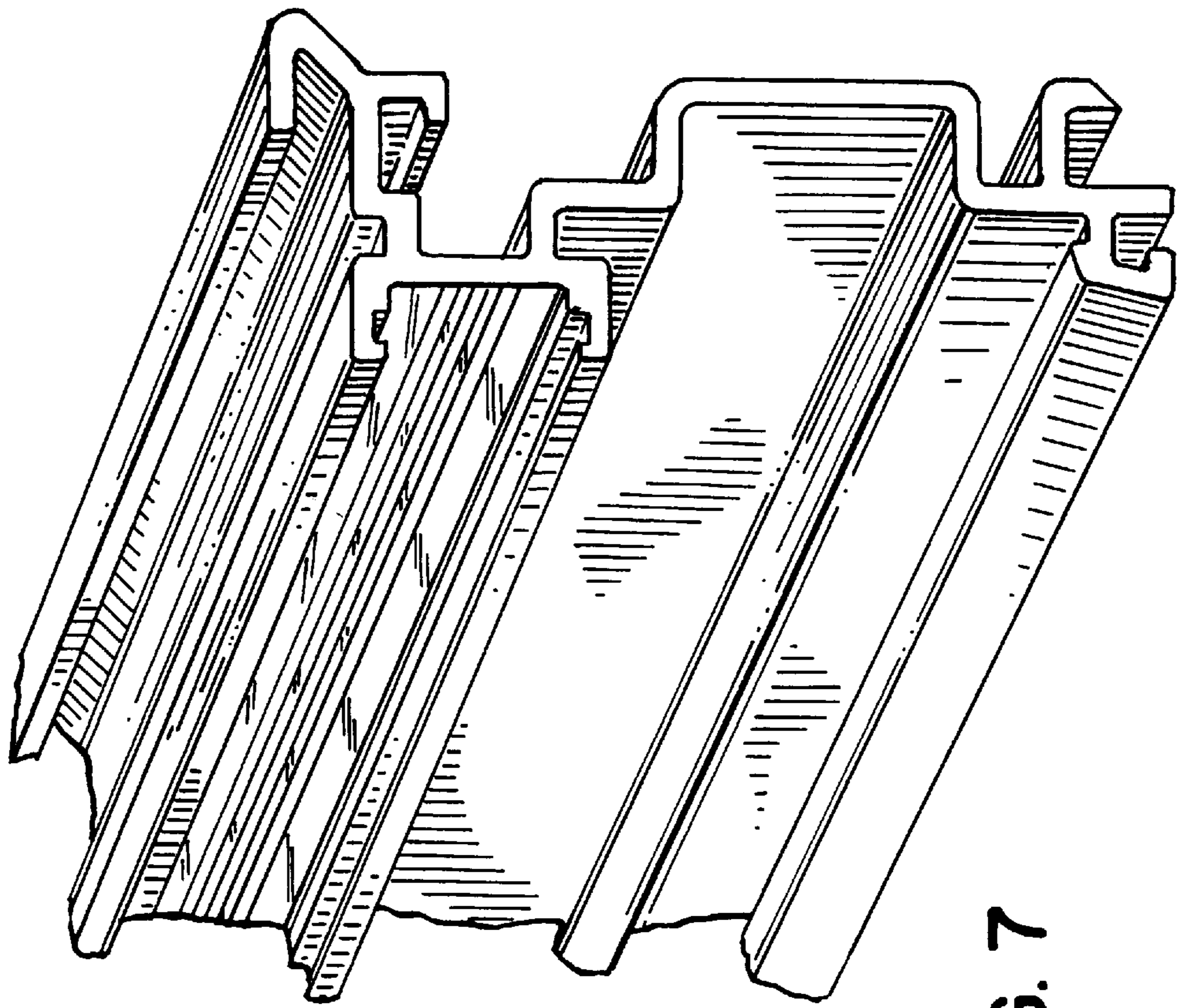

FIG. 7