



US00D398018S

United States Patent [19]
Lee

[11] **Patent Number: Des. 398,018**
[45] **Date of Patent: **Sep. 8, 1998**

[54] **CAMERA FOR USE WITH A COMPUTER**

[75] Inventor: **Cheol-Ho Lee**, Incheon, Rep. of Korea

[73] Assignee: **Daewoo Telecom, Ltd.**, Rep. of Korea

[**] Term: **14 Years**

[21] Appl. No.: **75,594**

[22] Filed: **Aug. 4, 1997**

[30] **Foreign Application Priority Data**

Feb. 25, 1997 [KR] Rep. of Korea 973119

[51] **LOC (6) Cl.** **16-01**

[52] **U.S. Cl.** **D16/202**

[58] **Field of Search** D16/200, 205;
D14/114; 348/11-17, 373-376; 358/906;
379/53; 396/535-543

[56] **References Cited**

U.S. PATENT DOCUMENTS

- D. 262,117 12/1981 Sasaki D16/203
- D. 296,551 7/1988 Mizogui D16/202
- D. 357,929 5/1995 Pierce D16/202
- D. 363,730 10/1995 Flohr et al. D16/202

D. 383,475 9/1997 Yamauchi et al. D16/202

Primary Examiner—Sandra L. Morris
Assistant Examiner—Adir Aronovich
Attorney, Agent, or Firm—Pennie & Edmonds LLP

[57] **CLAIM**

The ornamental design for a camera for use with a computer, as shown and described.

DESCRIPTION

FIG. 1 is a perspective view of a camera for use with a computer showing my new design; FIG. 2 is a front elevational view thereof; FIG. 3 is a rear elevational view thereof; FIG. 4 is a top plan view thereof; FIG. 5 is a bottom plan view thereof; FIG. 6 is a left side elevational view thereof, which is symmetrical to a right side elevational view not shown herein; and, FIG. 7 is a reduced perspective view thereof, with the camera attached to a computer. The broken line showing of a computer is for illustrative purposes only and forms no part of the claimed design.

1 Claim, 6 Drawing Sheets

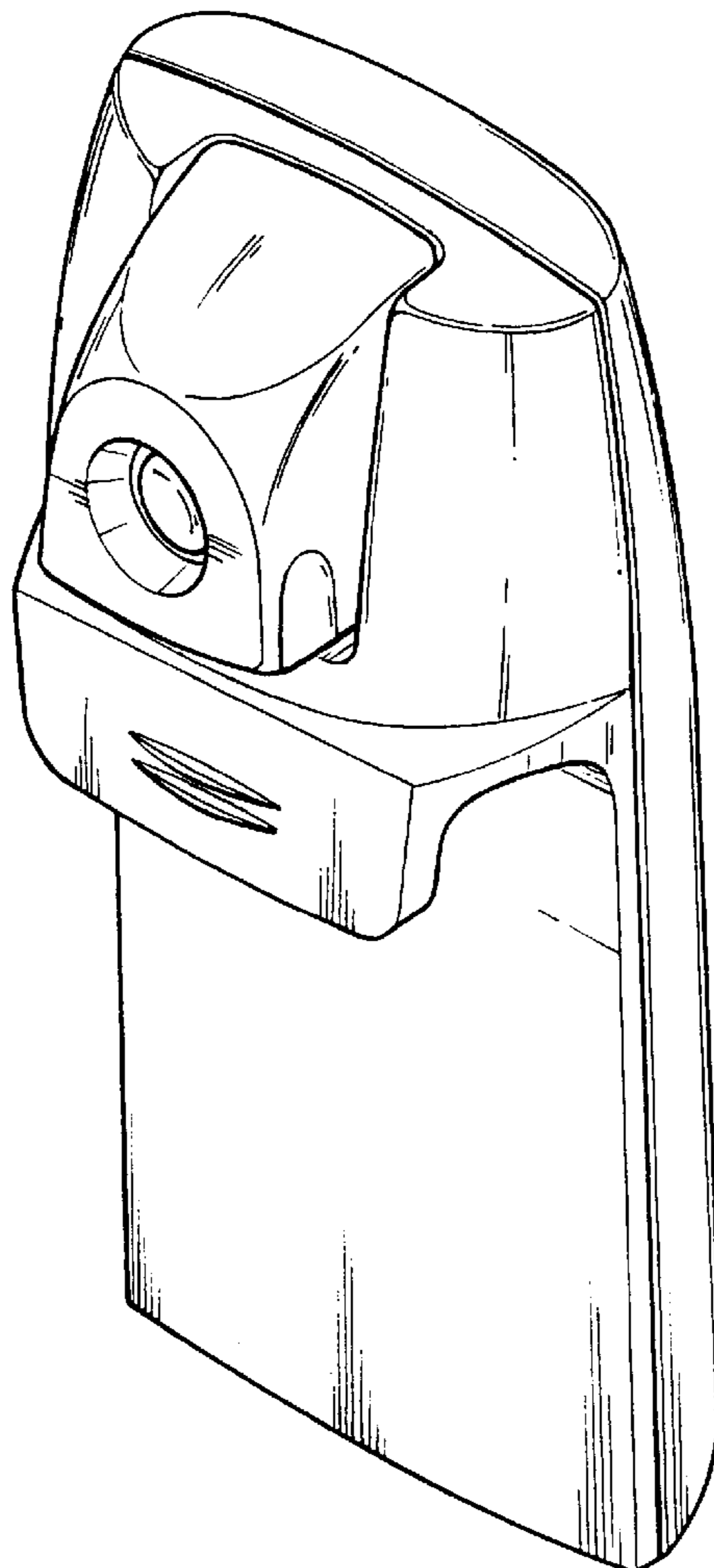

FIG. 1

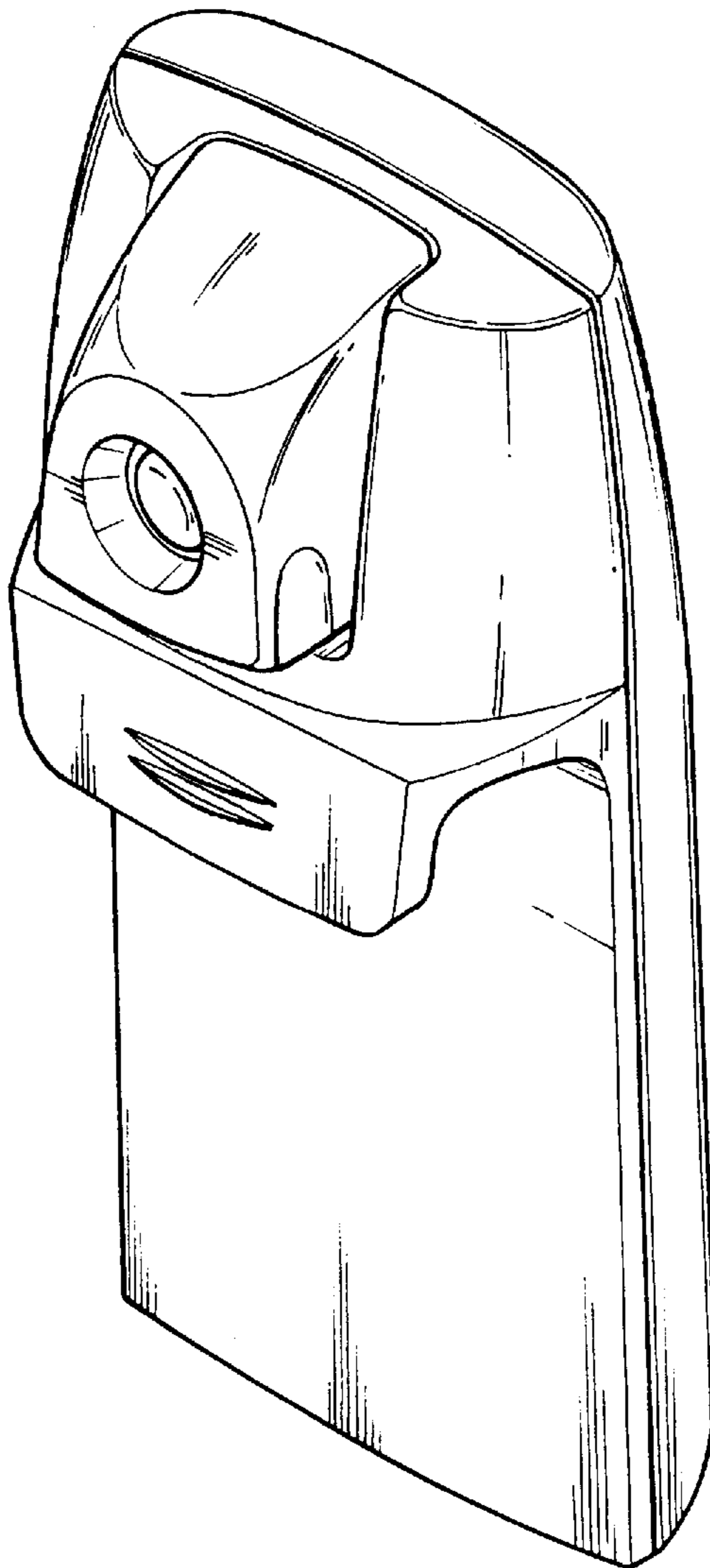

FIG. 2

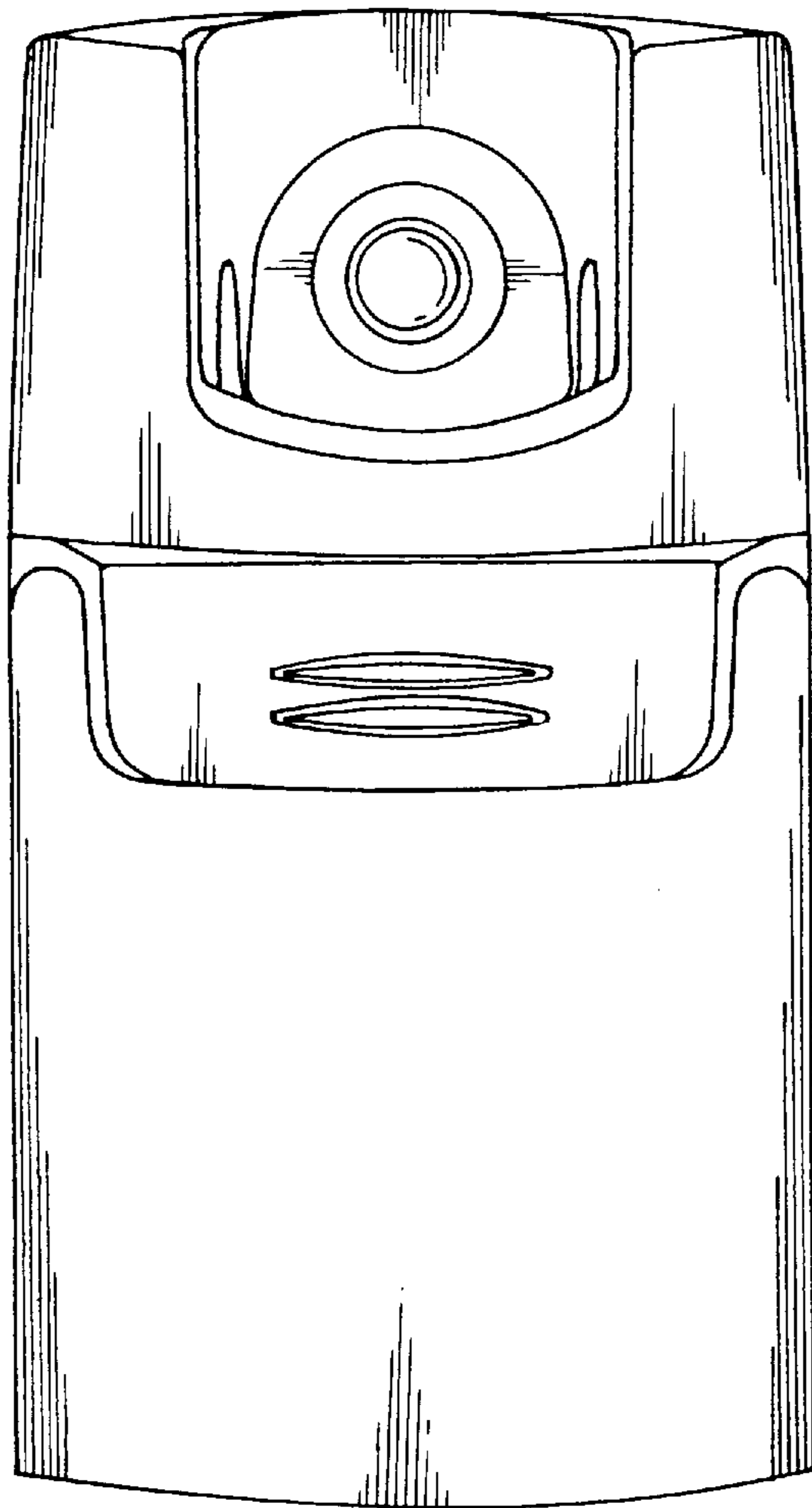

FIG. 3

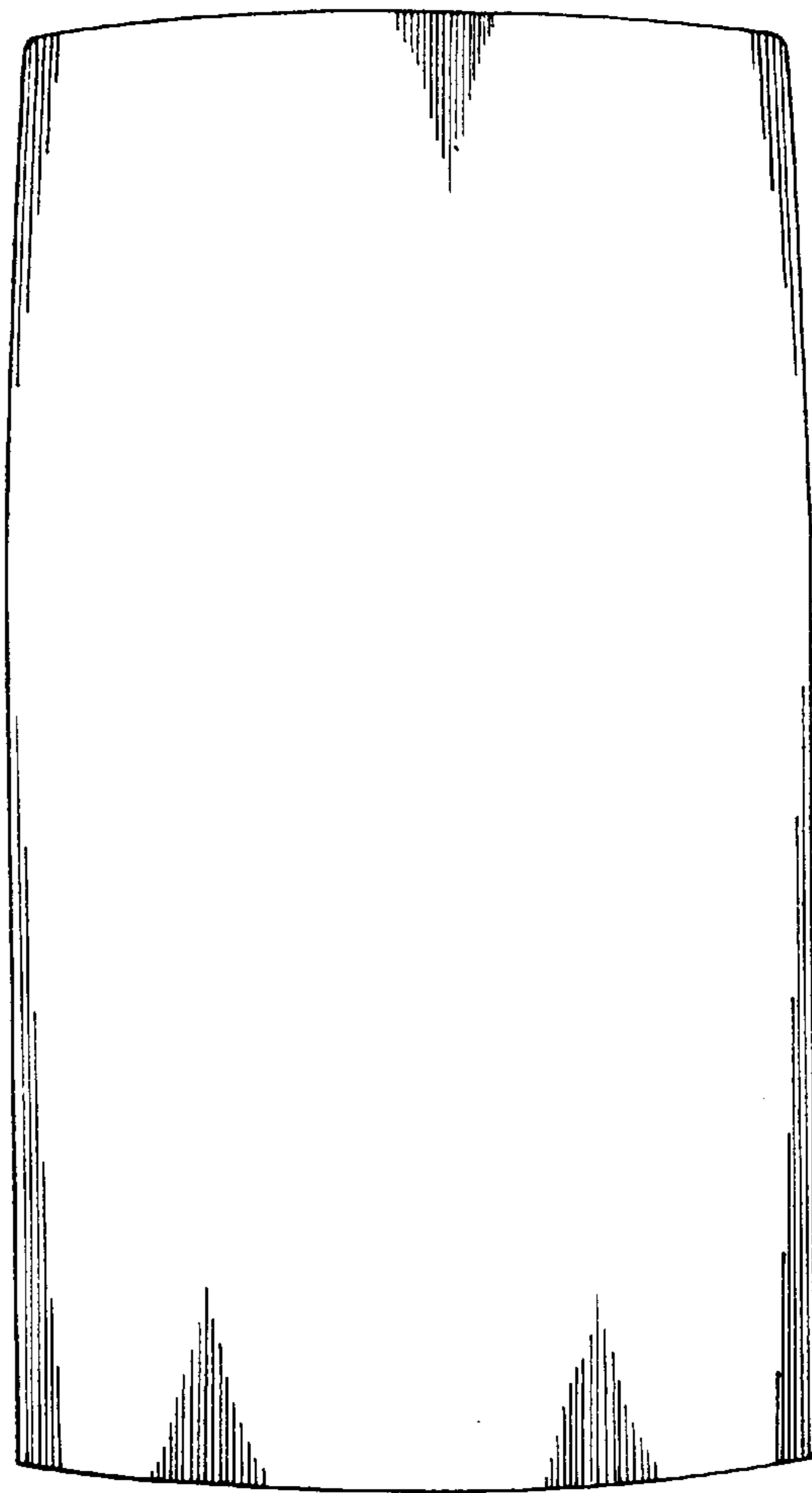

FIG. 4

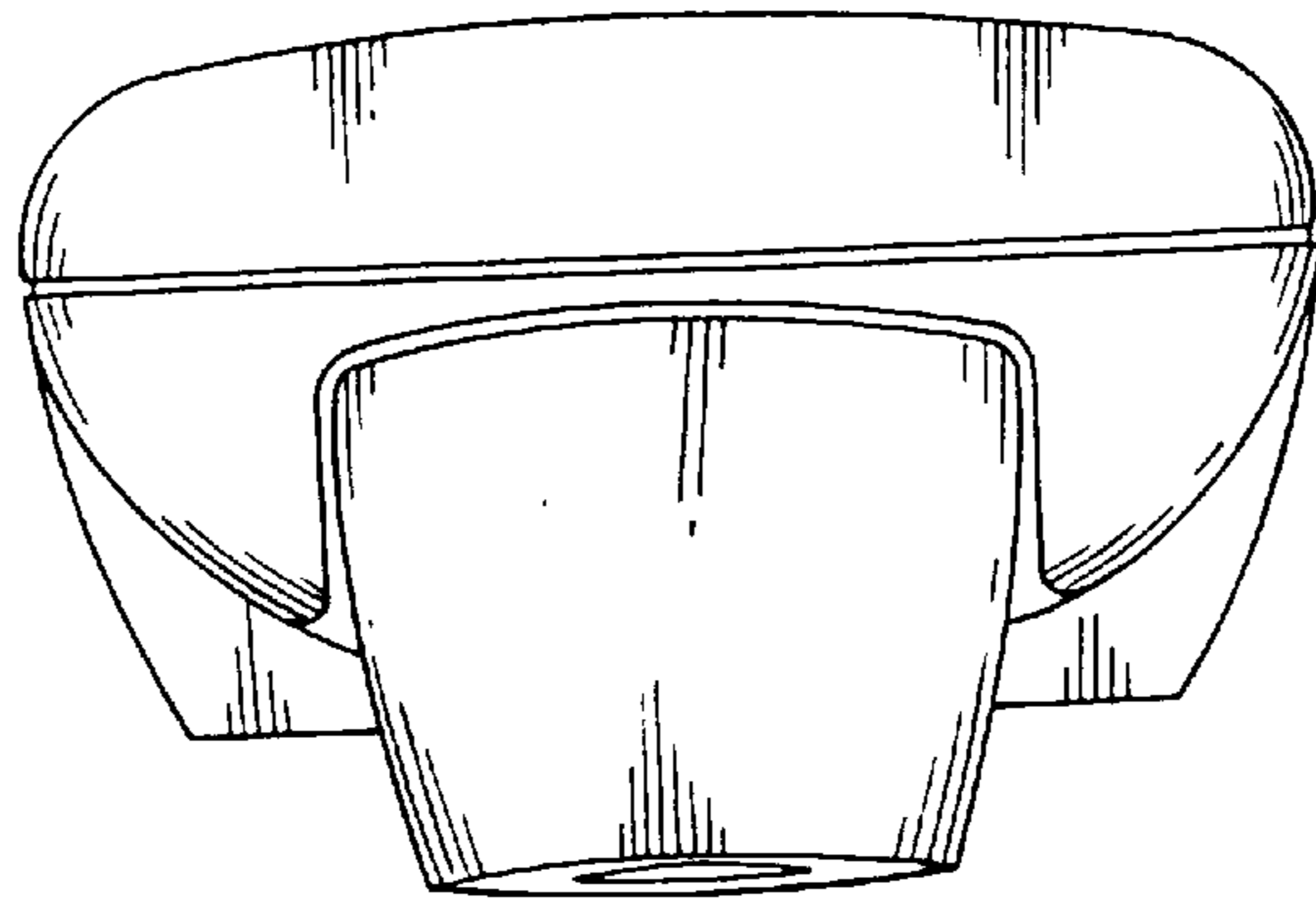

FIG. 5

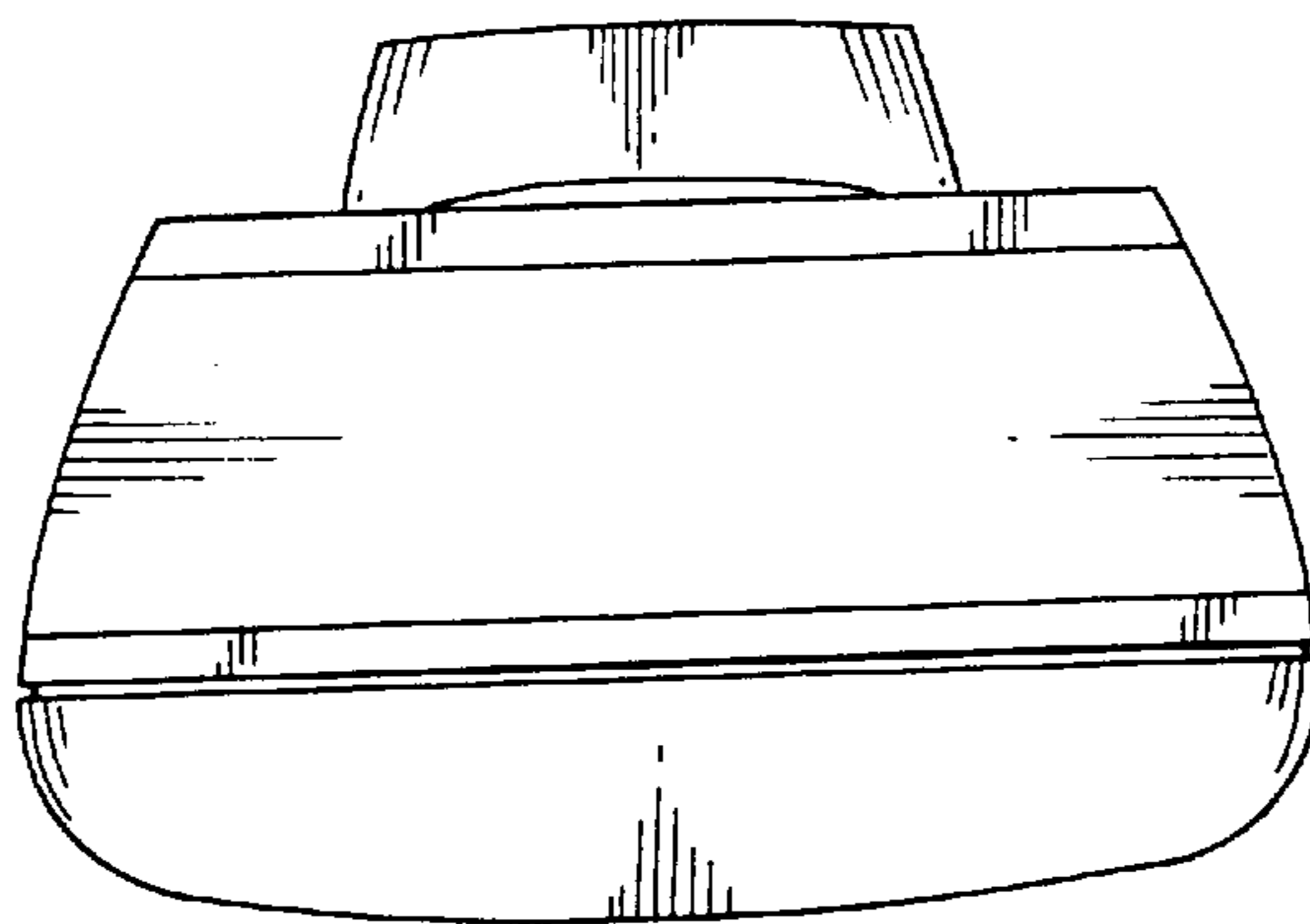

FIG. 6

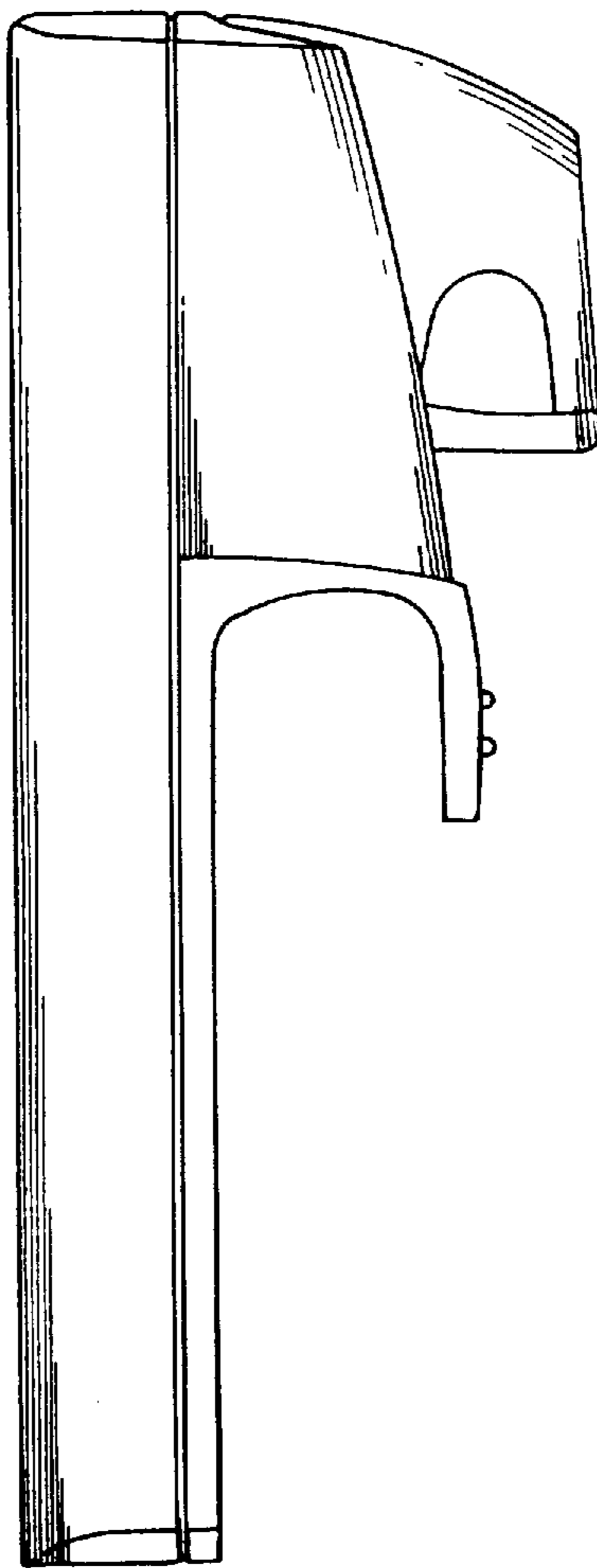

FIG. 7

