



US00D397978S

# United States Patent [19]

[11] **Patent Number: Des. 397,978**

**Helgeson et al.**

[45] **Date of Patent: \*\*Sep. 8, 1998**

[54] **PICKUP TAILGATE**

[57] **CLAIM**

[76] Inventors: **Jay Helgeson; Eric Helgeson**, both of  
14 Currie Court, S.E., Medicine Hat,  
AB, Canada, T1B 1R8

The ornamental design for a pickup tailgate; as shown and  
described.

[\*\*] Term: **14 Years**

**DESCRIPTION**

[21] Appl. No.: **59,405**

FIG. 1 is a perspective view of a pickup tailgate showing my  
new design;

[22] Filed: **Sep. 10, 1996**

FIG. 2 is a left side view of the tailgate portion thereof;

[51] **LOC (6) Cl.** ..... **12-16**

FIG. 3 is a right side view thereof;

[52] **U.S. Cl.** ..... **D12/196**

FIG. 4 is a front view thereof;

[58] **Field of Search** ..... D12/98, 96, 196;  
296/26, 27, 50, 55, 57.1, 60, 180.1; 410/129

FIG. 5 is a rear view thereof;

FIG. 6 is a top view thereof;

FIG. 7 is a bottom view thereof;

FIG. 8 is a top view of the side mounted portion;

FIG. 9 is a bottom view thereof;

FIG. 10 is a right side view thereof;

The left side view is a mirror image thereof;

FIG. 11 is a top view thereof;

FIG. 12 is a bottom view thereof;

FIG. 13 is a top view of the floor mounted portion;

FIG. 14 is a bottom view thereof;

FIG. 15 is a right side view thereof;

The left side is a mirror image thereof;

FIG. 16 is a front side view thereof; and,

The rear side is a mirror image thereof.

[56] **References Cited**

**U.S. PATENT DOCUMENTS**

|            |         |                 |       |            |
|------------|---------|-----------------|-------|------------|
| D. 370,453 | 6/1996  | Shortman et al. | ..... | D12/223    |
| D. 380,707 | 7/1997  | Gallegus        | ..... | D12/98     |
| 5,234,249  | 8/1993  | Dorrell         | ..... | 296/180.1  |
| 5,468,037  | 11/1995 | Peterson et al. | ..... | 296/57.1   |
| 5,645,310  | 7/1997  | McLaughlin      | ..... | 296/57.1 X |
| 5,669,654  | 9/1997  | Eilers et al.   | ..... | 296/26     |

*Primary Examiner*—Melody N. Brown  
*Attorney, Agent, or Firm*—Harold H. Dutton, Jr.

**1 Claim, 8 Drawing Sheets**

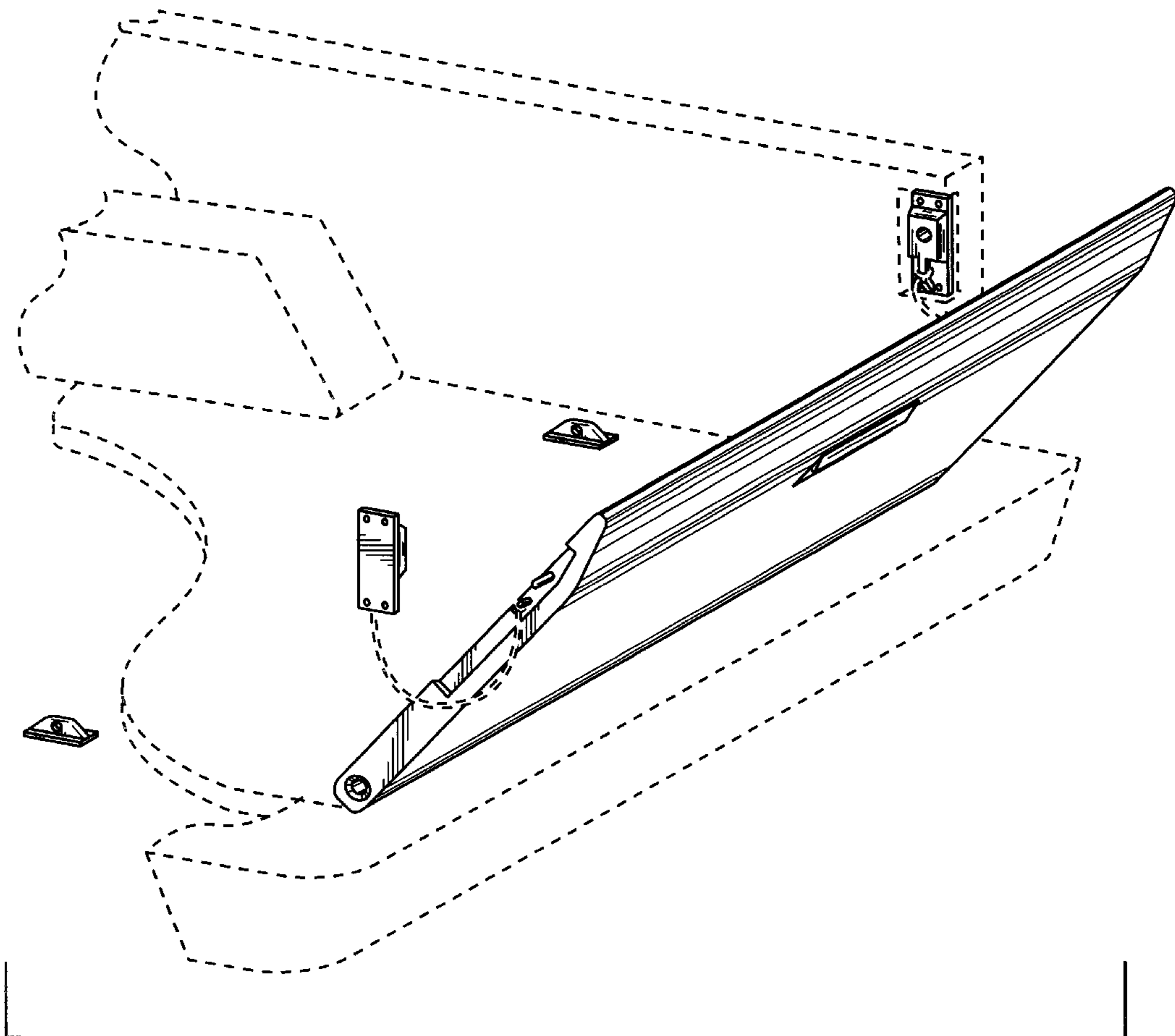

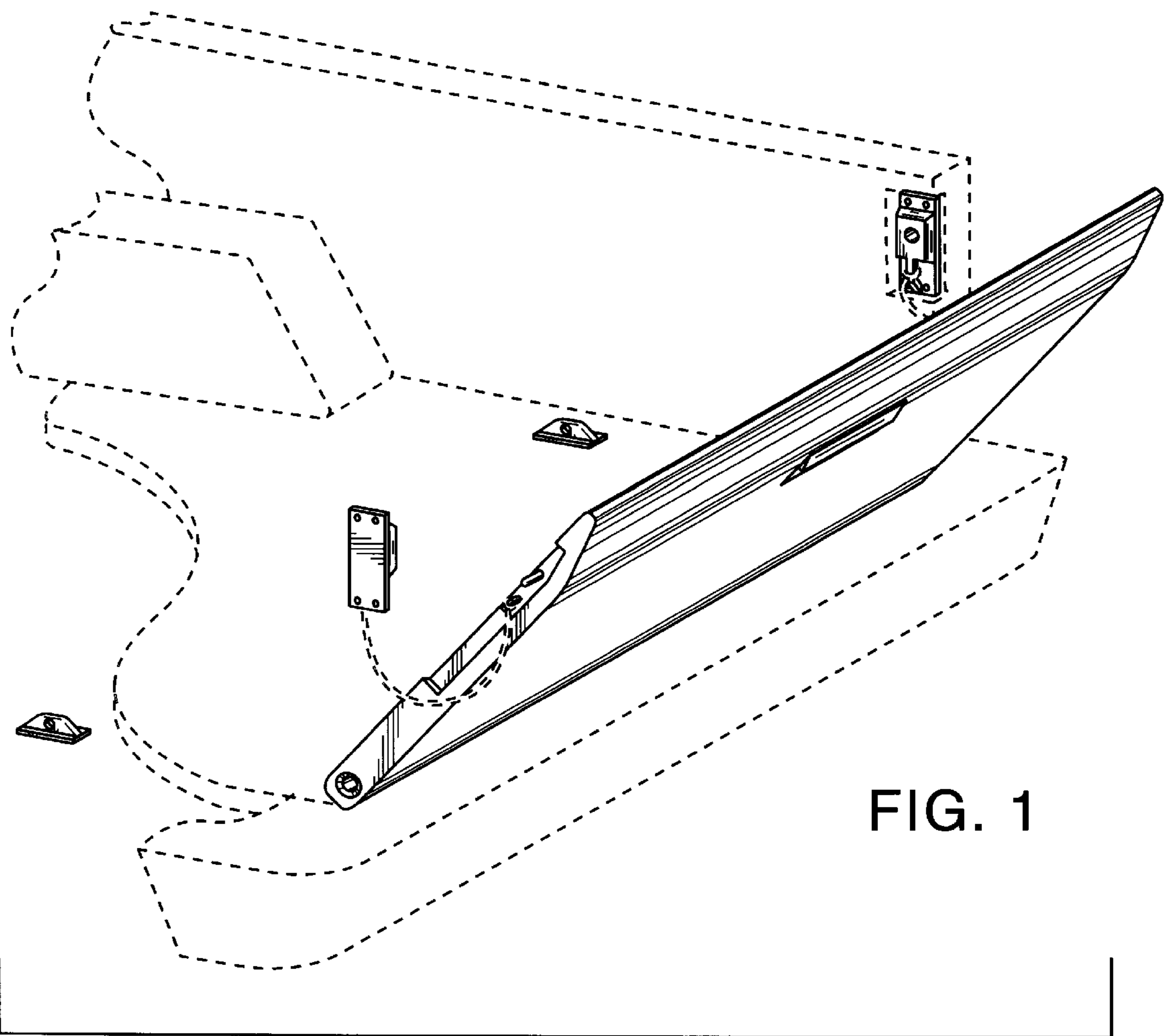

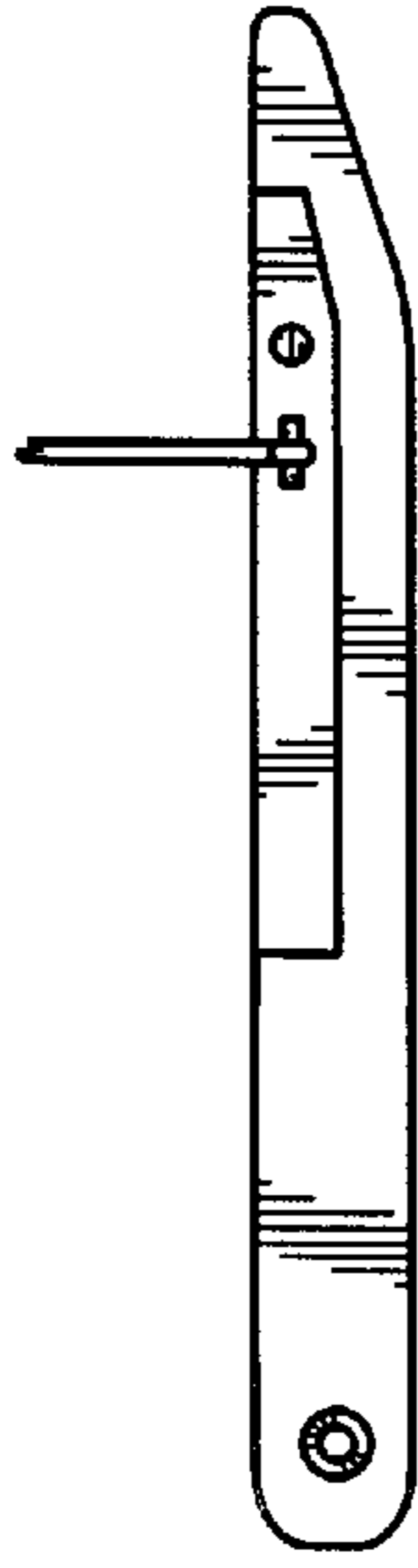

FIG. 2

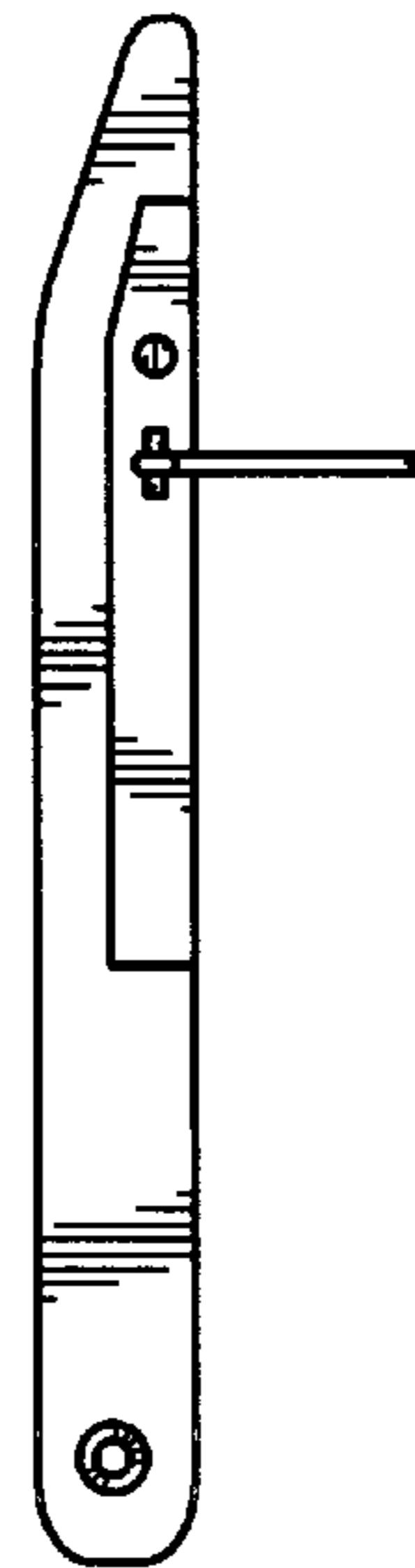

FIG. 3

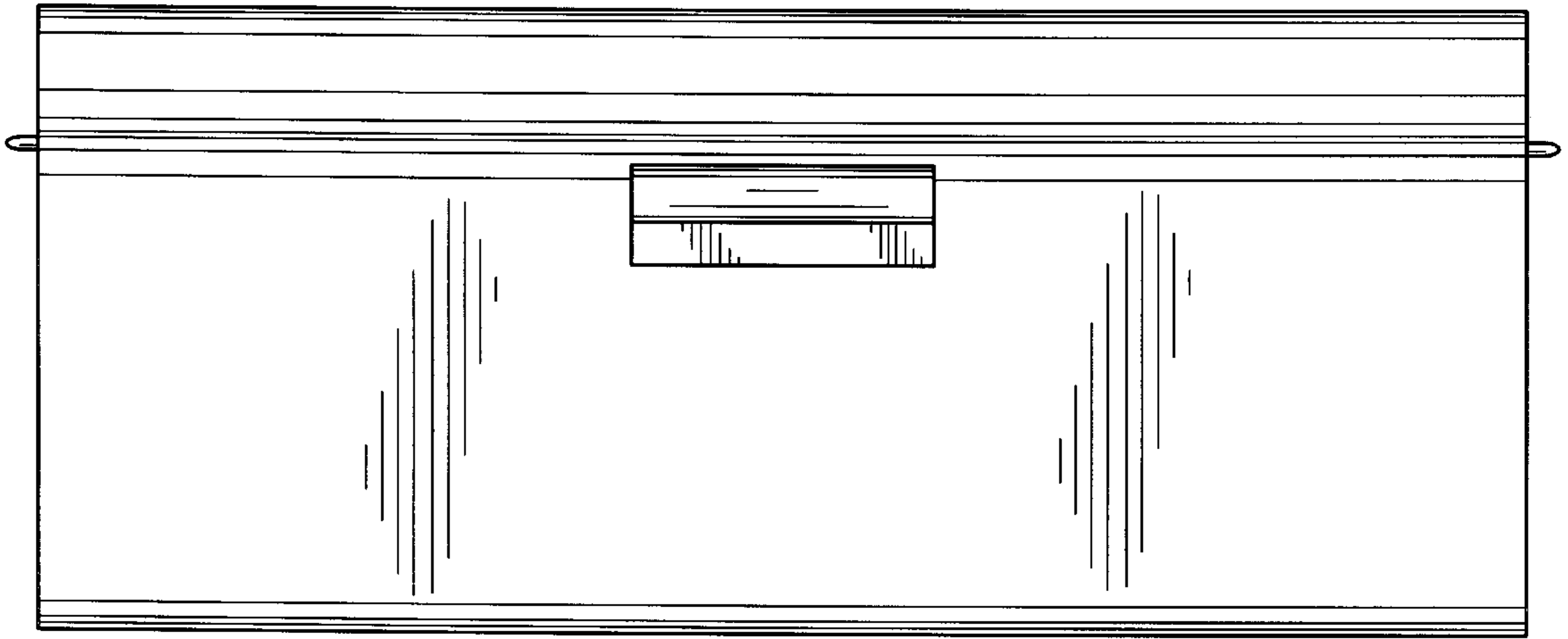

FIG. 4

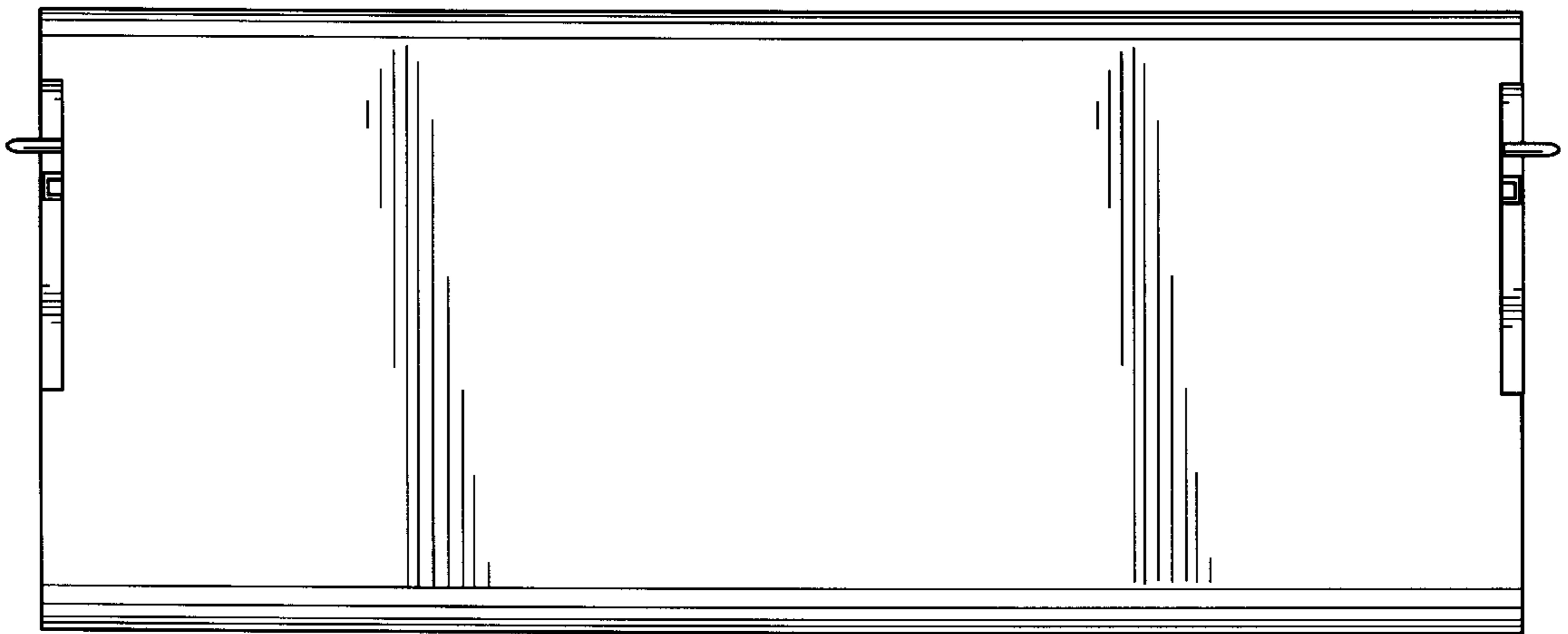

FIG. 5

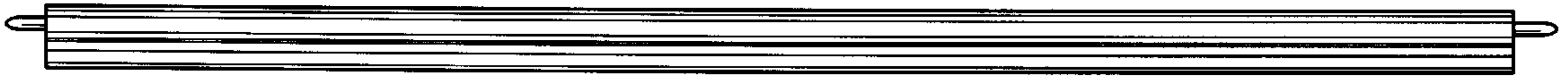

FIG. 6

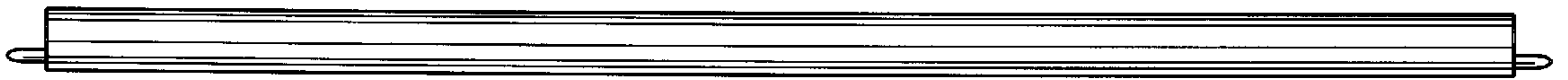

FIG. 7

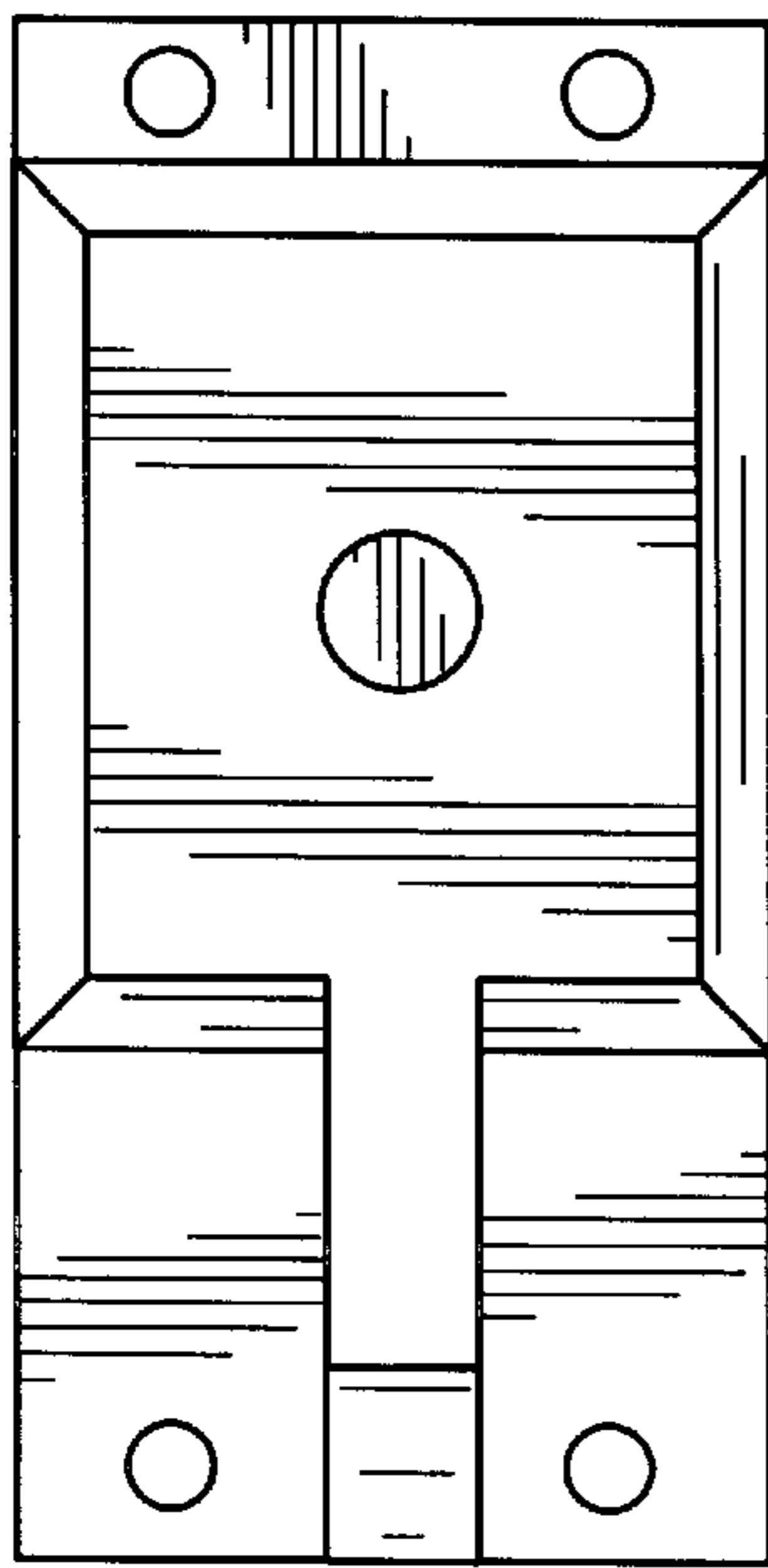
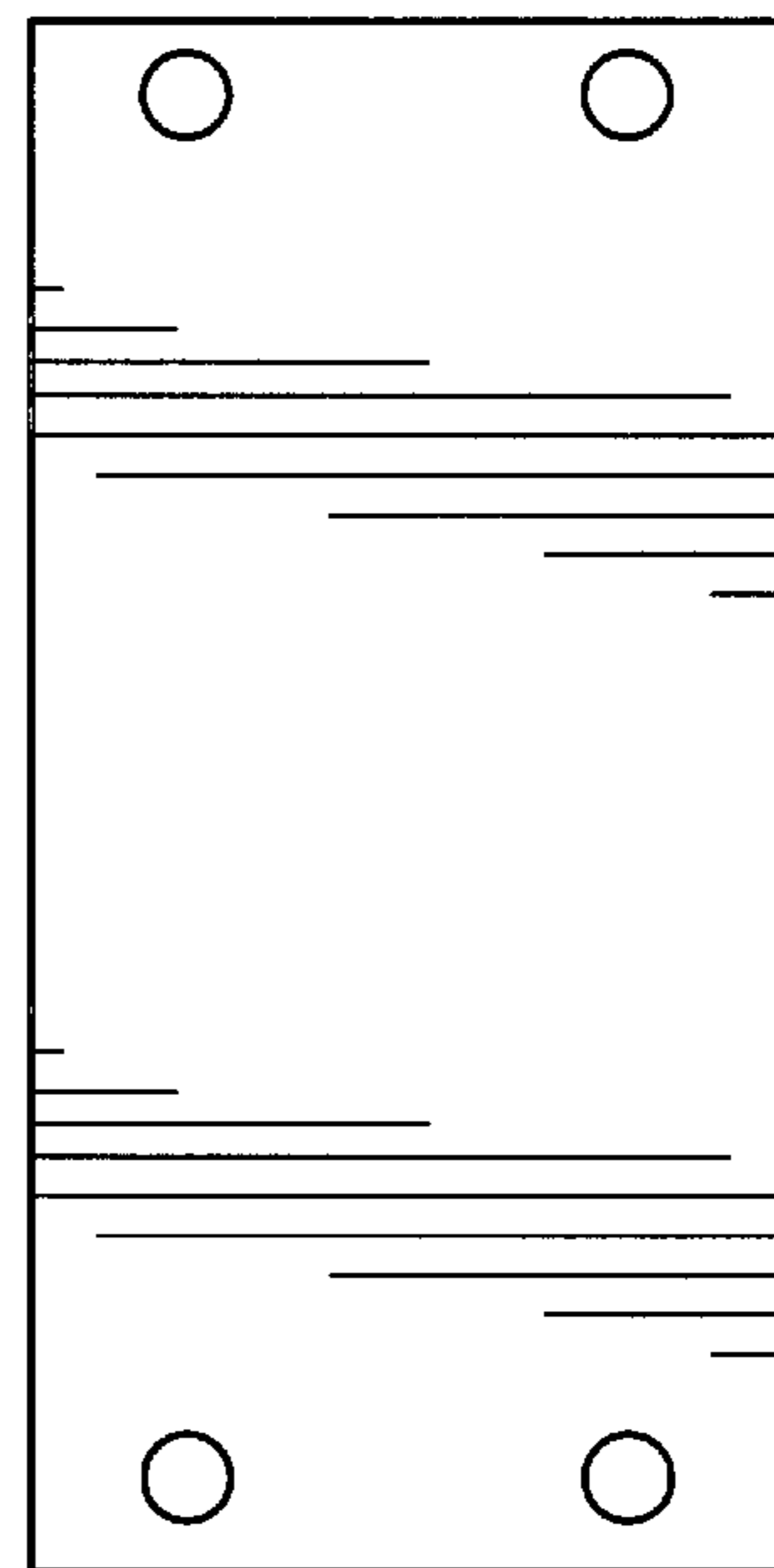

FIG. 8

FIG. 9



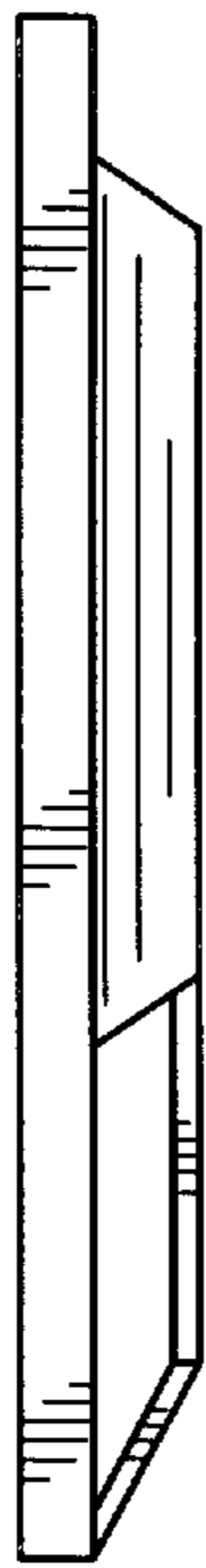

FIG. 10

FIG. 11

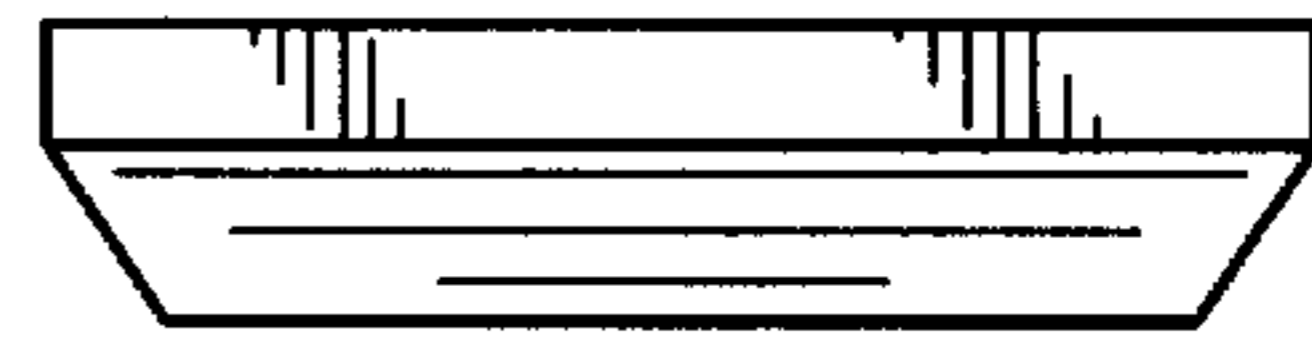
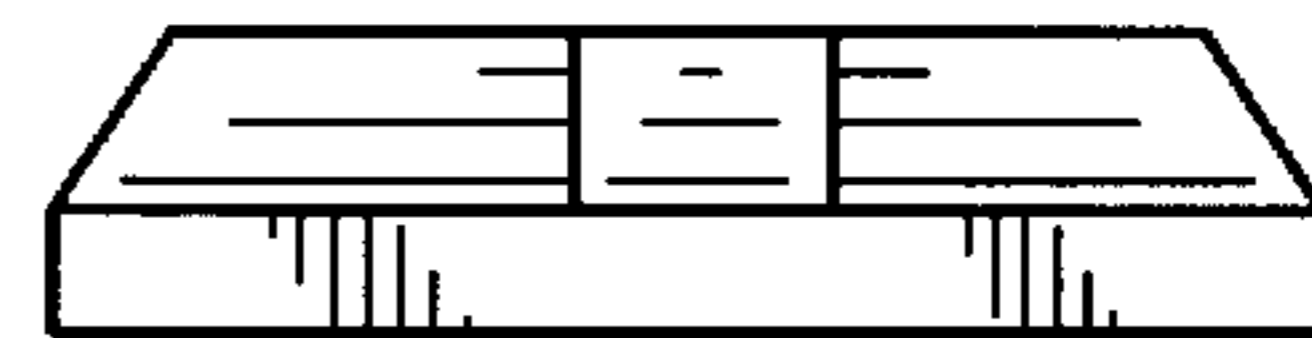

FIG. 12





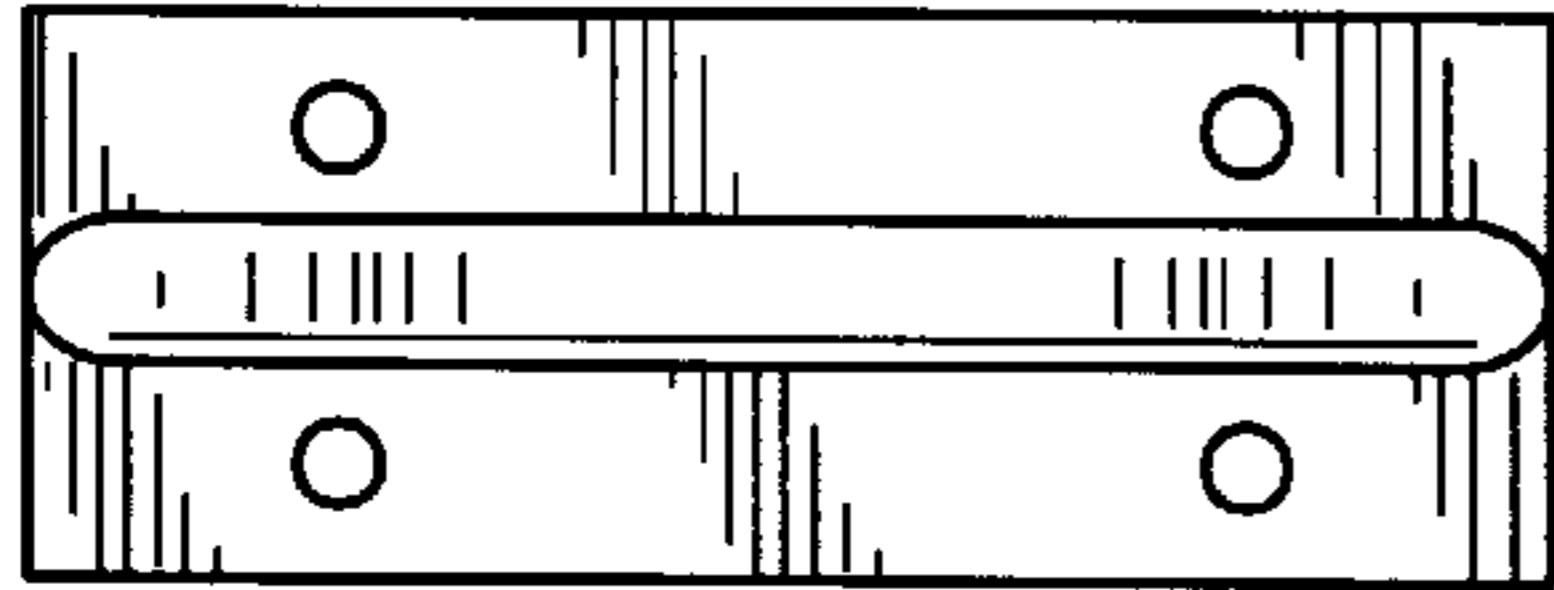

FIG. 13

FIG. 14

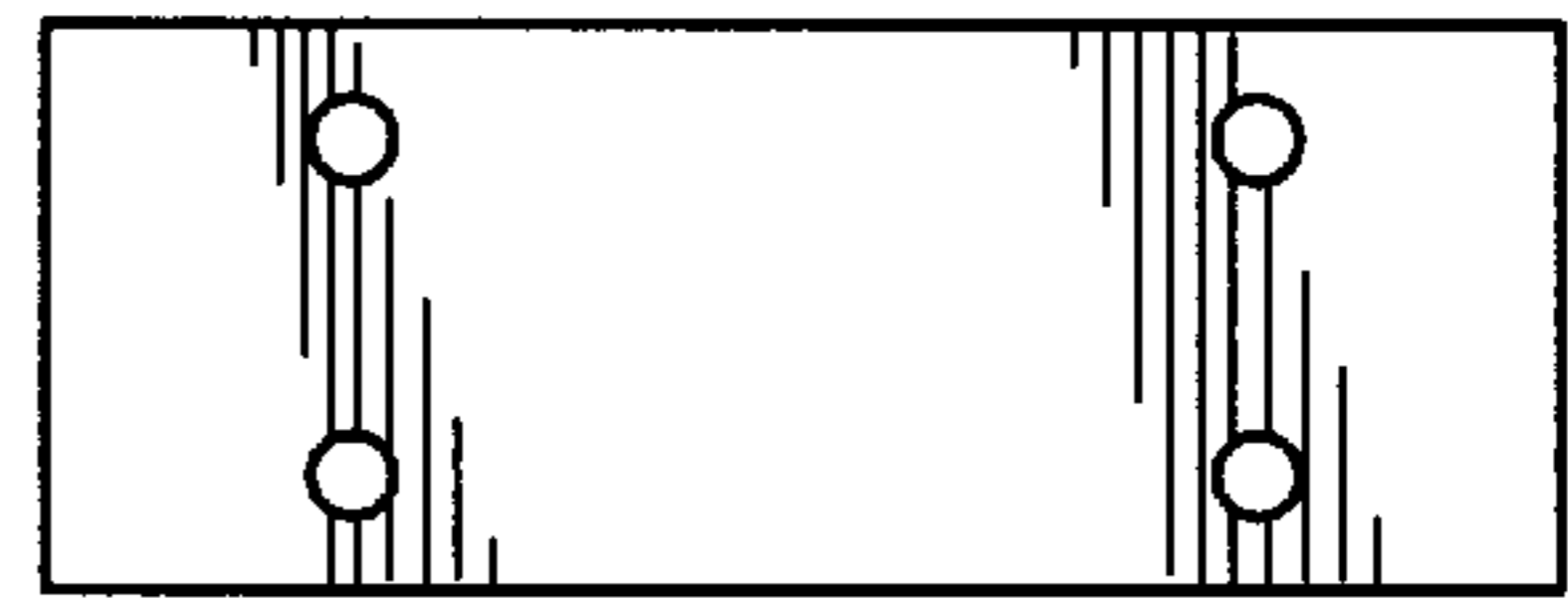

FIG. 15

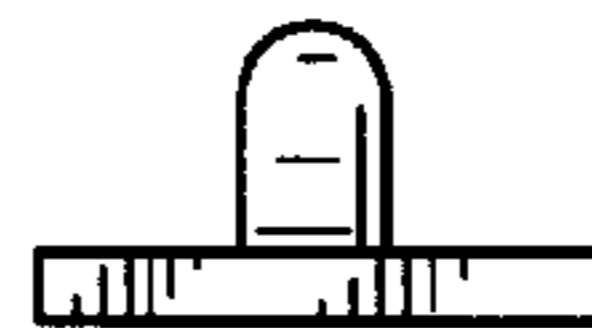

FIG. 16