



US00D397898S

United States Patent [19]

Walters-Dowding et al.

[11] **Patent Number: Des. 397,898**

[45] **Date of Patent: **Sep. 8, 1998**

[54] **SPICE RACK**

[75] Inventors: **Andrea Walters-Dowding**, Dresden, Ohio; **Durward L. Staten**, Mountain View, Ark.

[73] Assignee: **The Longaberger Company**, Newark, Ohio

[**] Term: **14 Years**

[21] Appl. No.: **75,904**

[22] Filed: **Jul. 28, 1997**

Related U.S. Application Data

[63] Continuation-in-part of Ser. No. 69,526, Apr. 24, 1997, which is a continuation-in-part of Ser. No. 69,271, Mar. 24, 1997.

[51] **LOC (6) Cl.** **06-04**

[52] **U.S. Cl.** **D6/574; D6/525**

[58] **Field of Search** D6/512, 513, 525, D6/553, 566, 567, 574; D7/590, 600; 108/152; 211/60.1, 74, 75

[56] References Cited

U.S. PATENT DOCUMENTS

D. 256,746 9/1980 Loveson D6/574

D. 365,239 12/1995 Emery et al. D6/566
2,546,587 3/1951 Eisenberg 108/152

Primary Examiner—Terry A. Wallace
Attorney, Agent, or Firm—Porter, Wright, Morris & Arthur

[57] CLAIM

The ornamental design for a spice rack, as shown and described.

DESCRIPTION

FIG. 1 is a front perspective view of the spice rack showing our new design;
FIG. 2 is a front elevation view thereof;
FIG. 3 is a top plan view thereof;
FIG. 4 is a bottom plan view thereof;
FIG. 5 is an rear elevation view thereof;
FIG. 6 is a side elevation view thereof, the other side being a mirror image thereof;
FIG. 7 is a front perspective view of another embodiment of the spice rack including an optional lower hanging rack;
FIG. 8 is a front elevation view of the spice rack of FIG. 7;
FIG. 9 is a bottom plan view thereof;
FIG. 10 is a rear elevation view thereof; and,
FIG. 11 is a side elevation view thereof, the other side being a mirror image thereof.

1 Claim, 6 Drawing Sheets

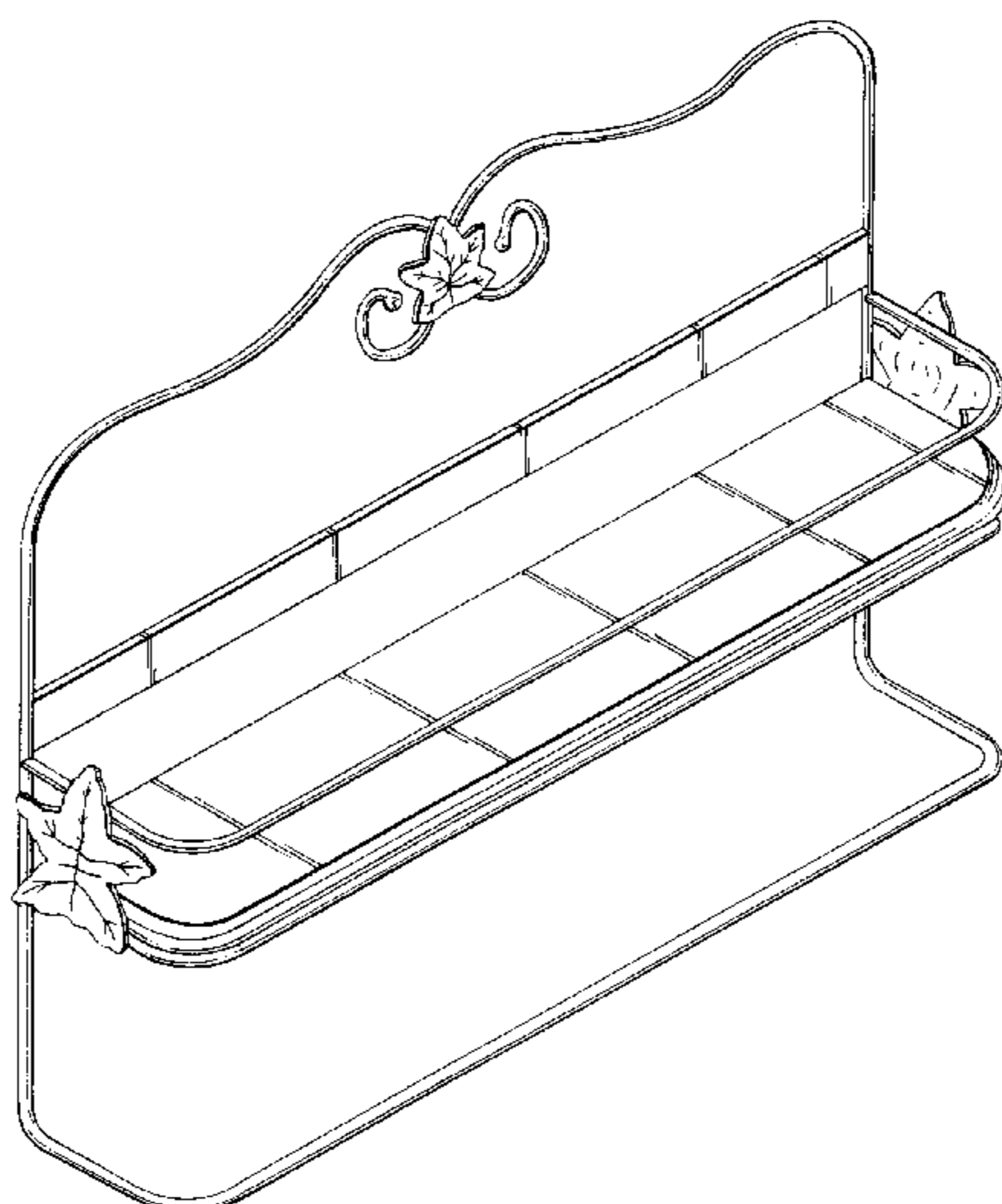
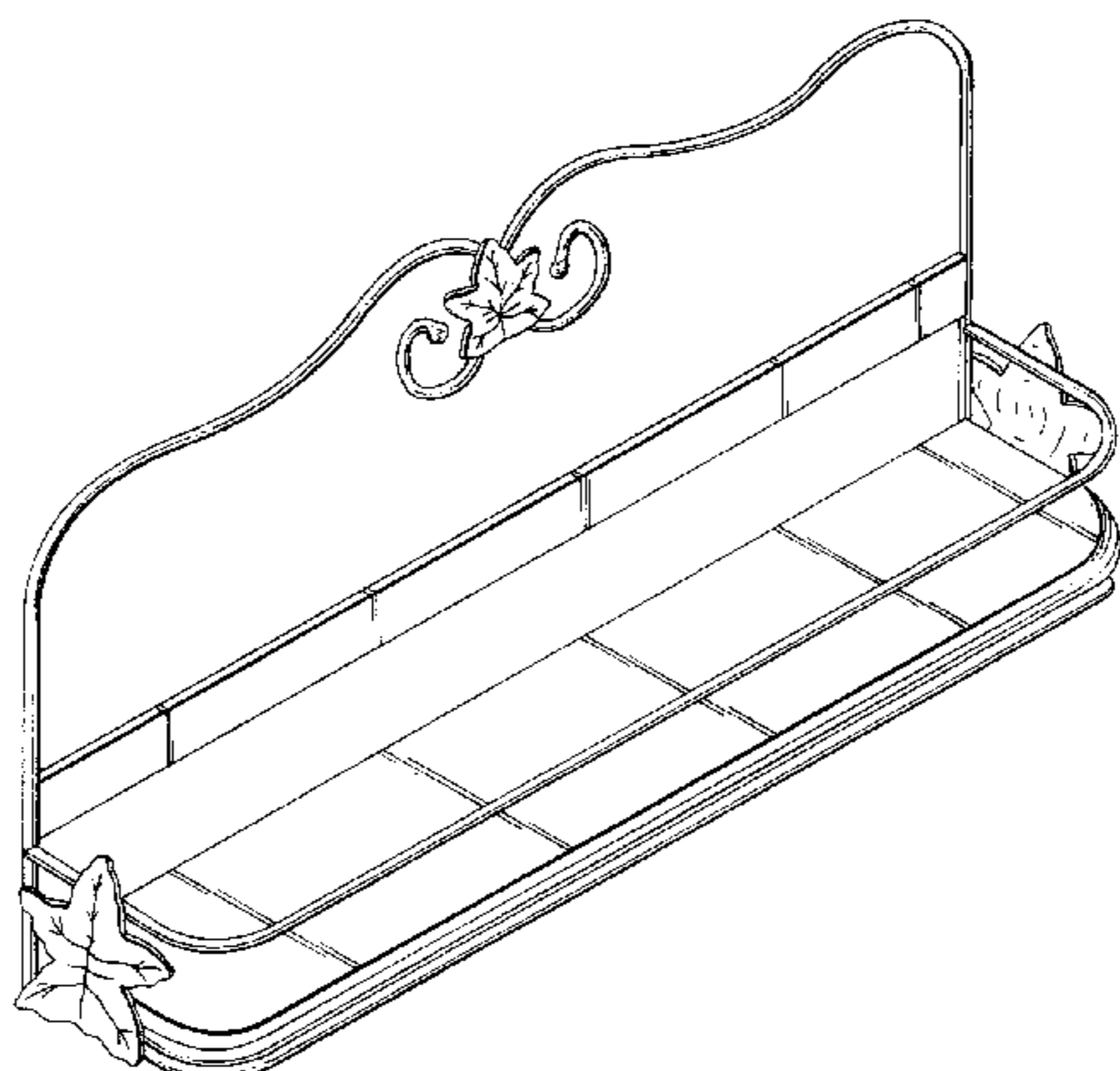

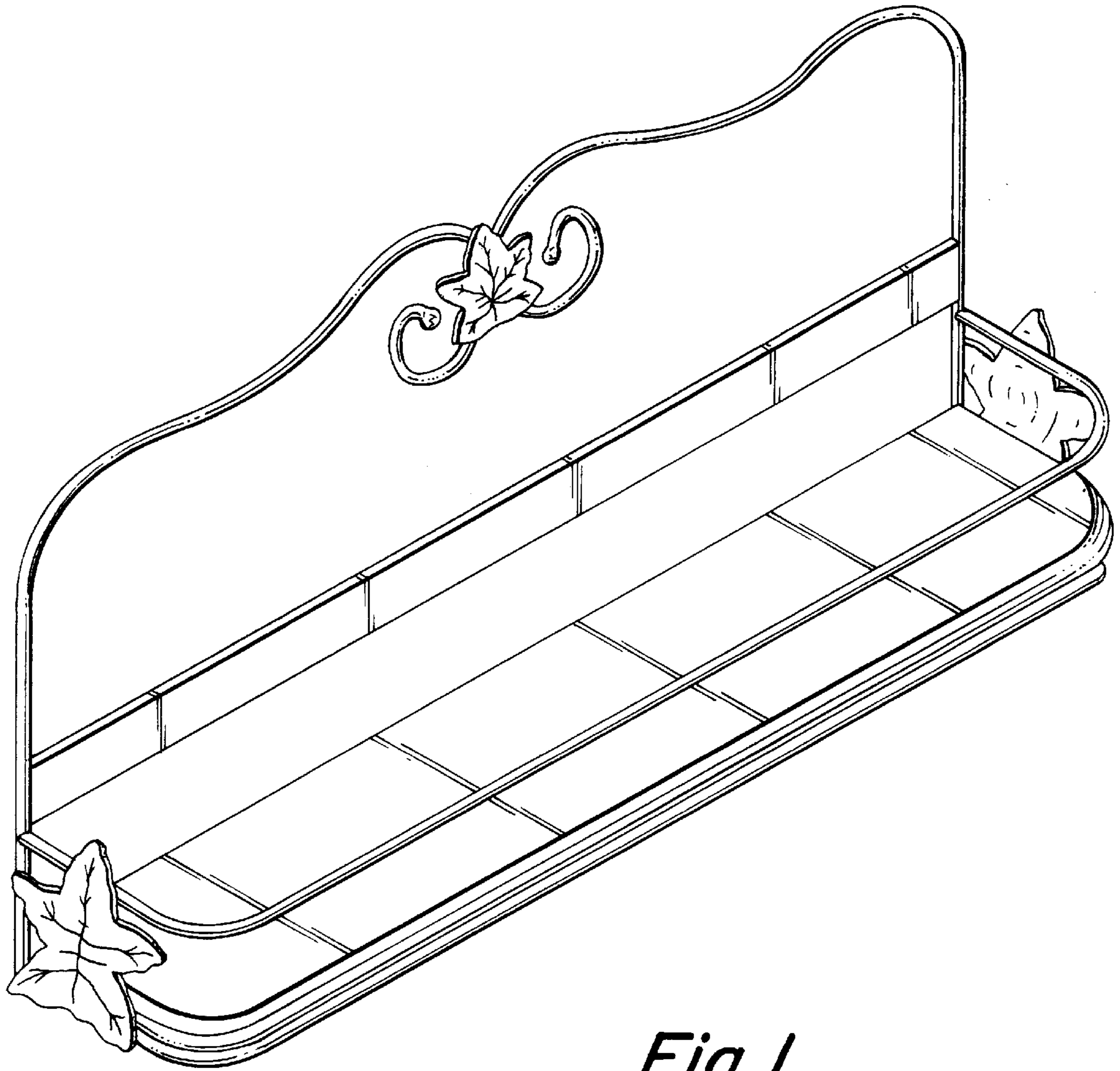

Fig. 1

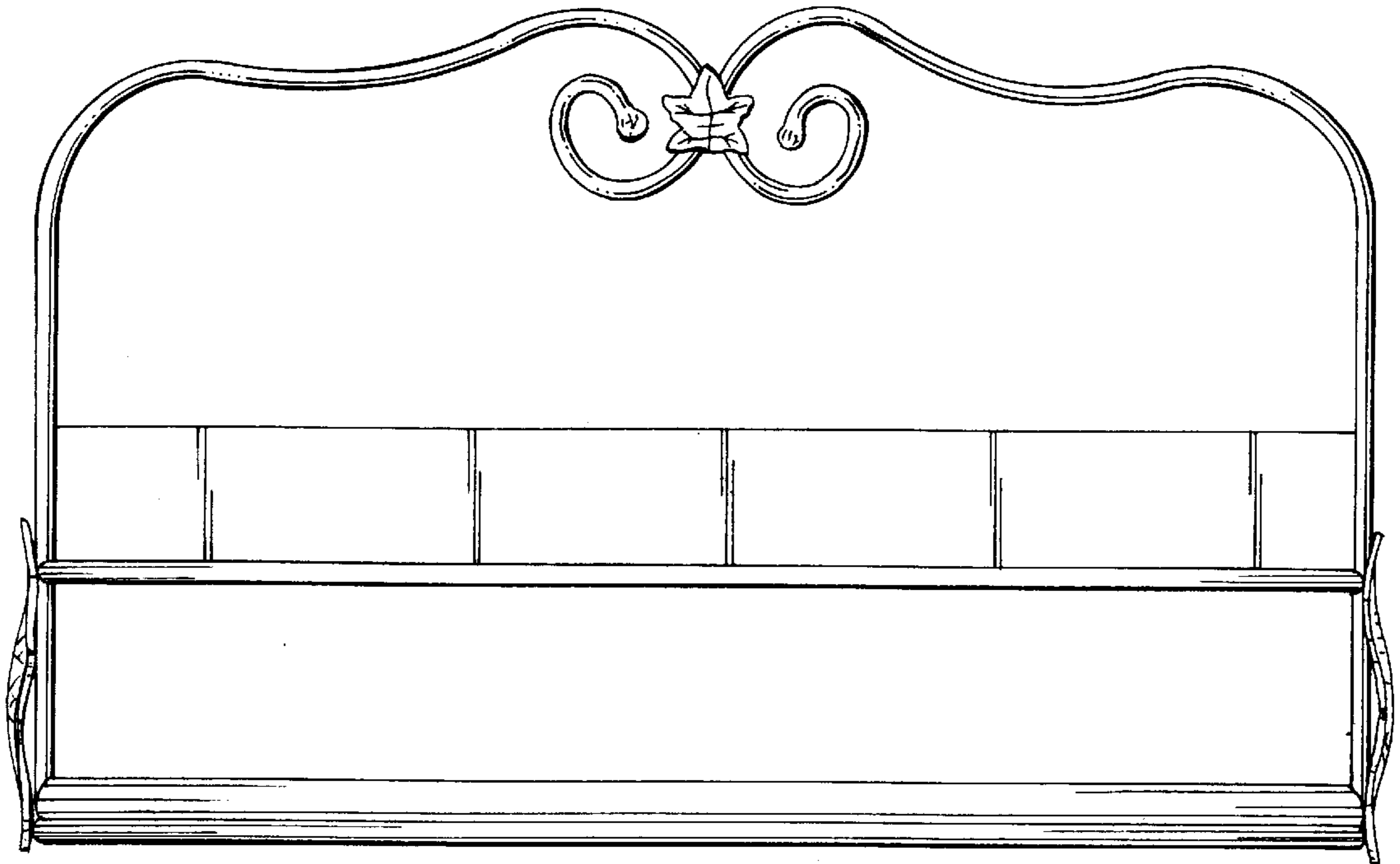

Fig. 2

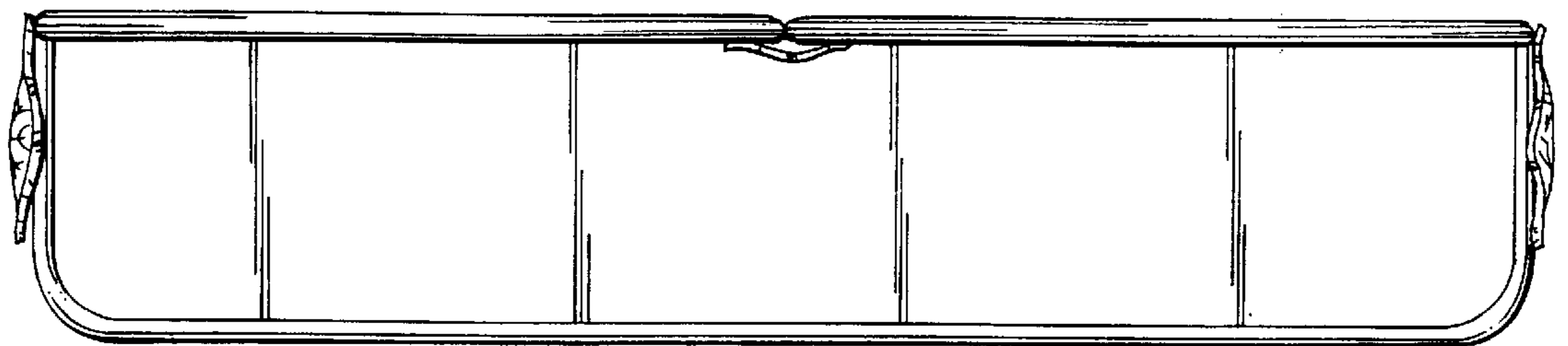

Fig. 3

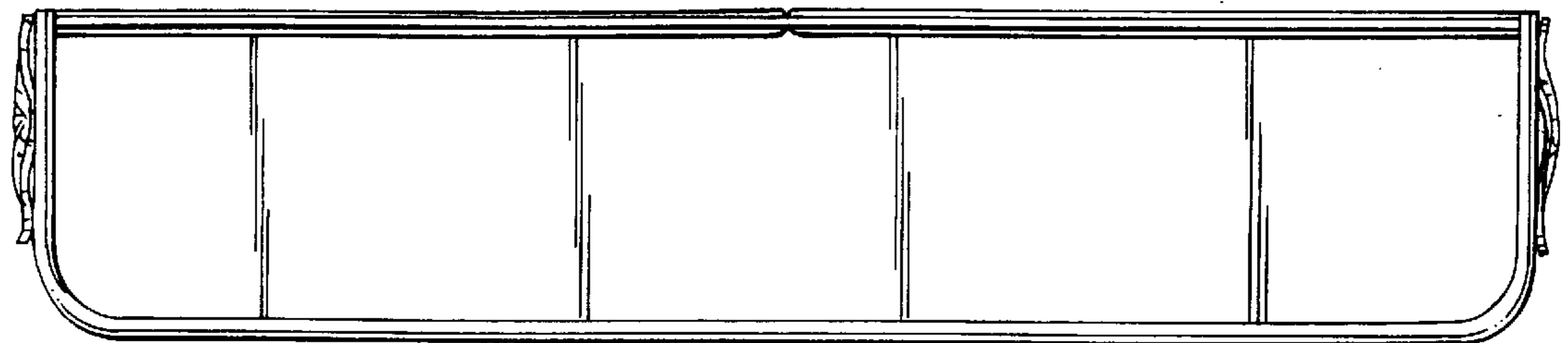

Fig. 4

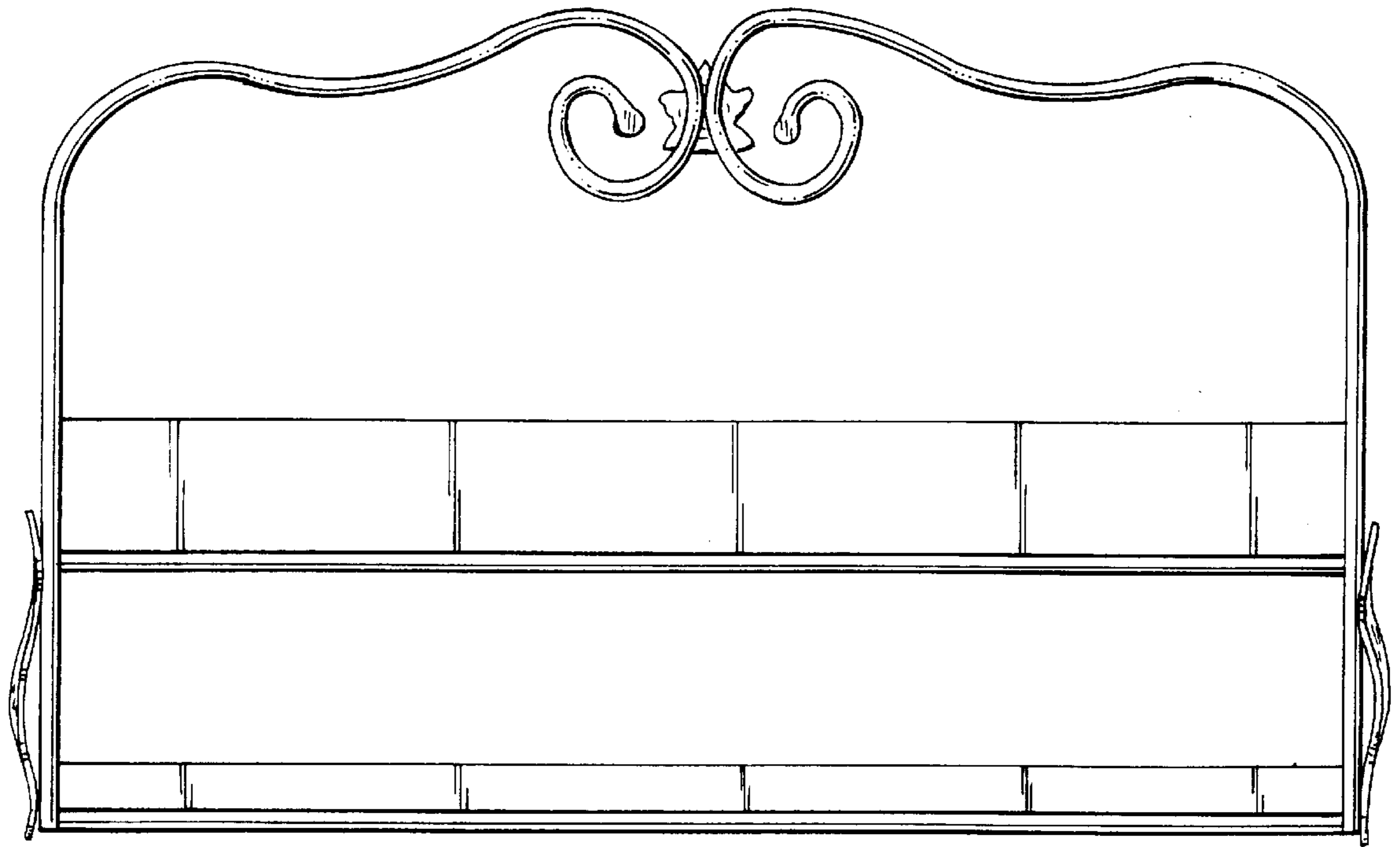

Fig. 5

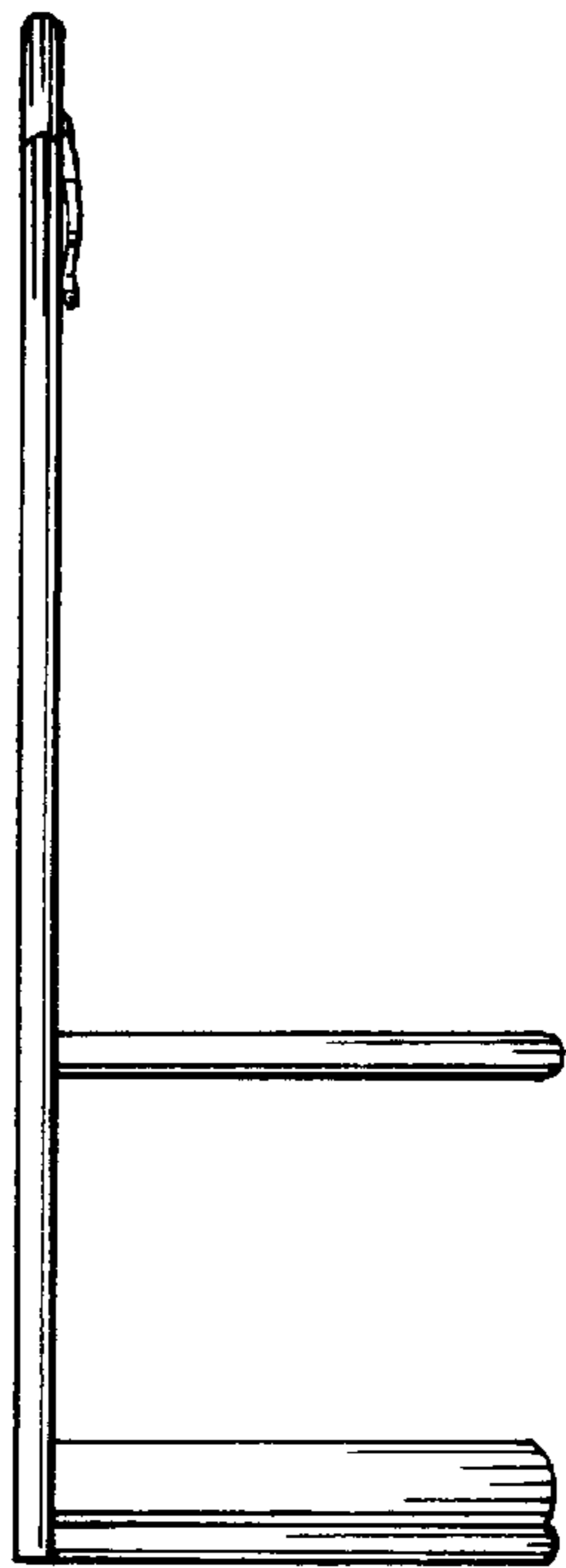

Fig. 6

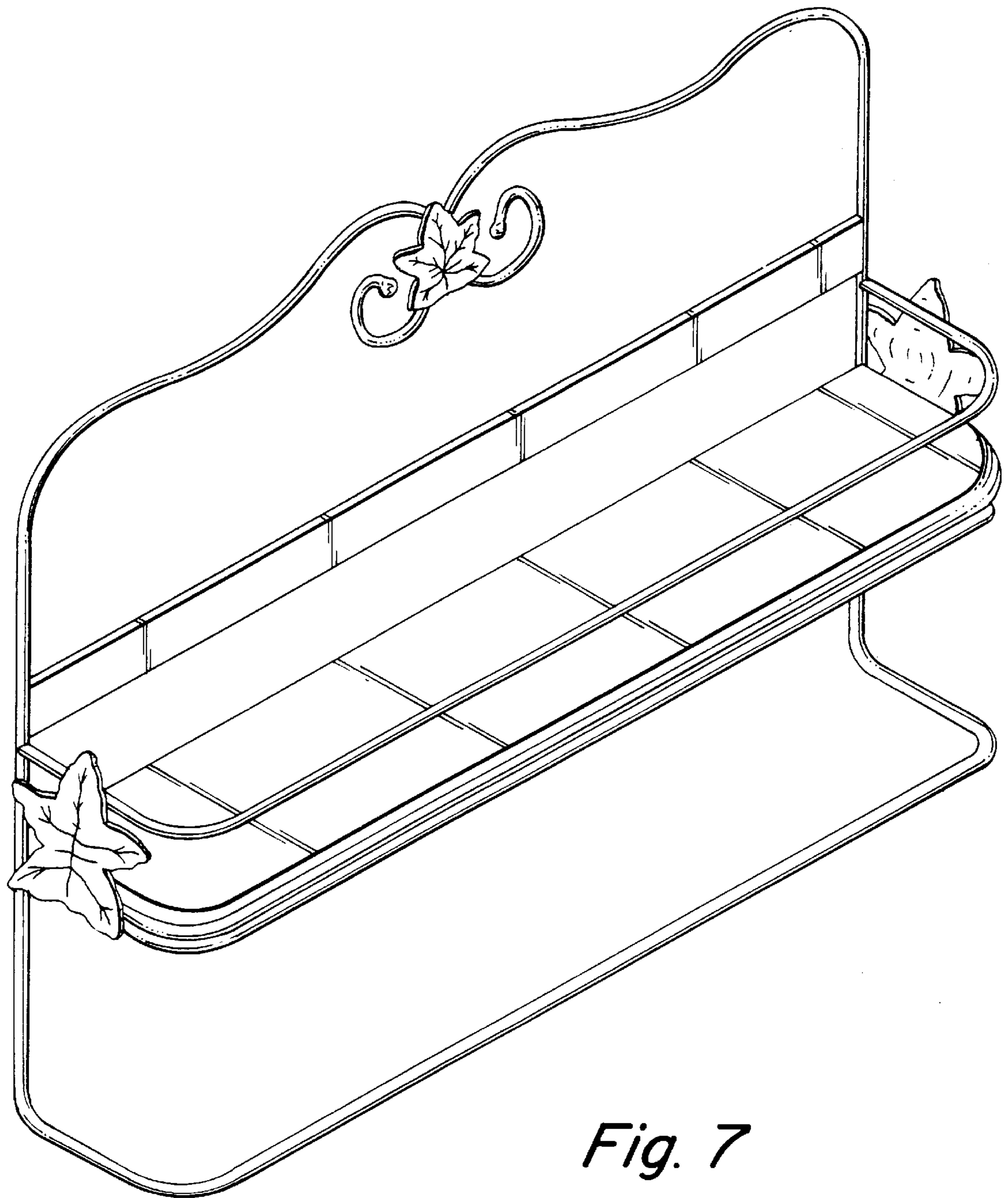

Fig. 7

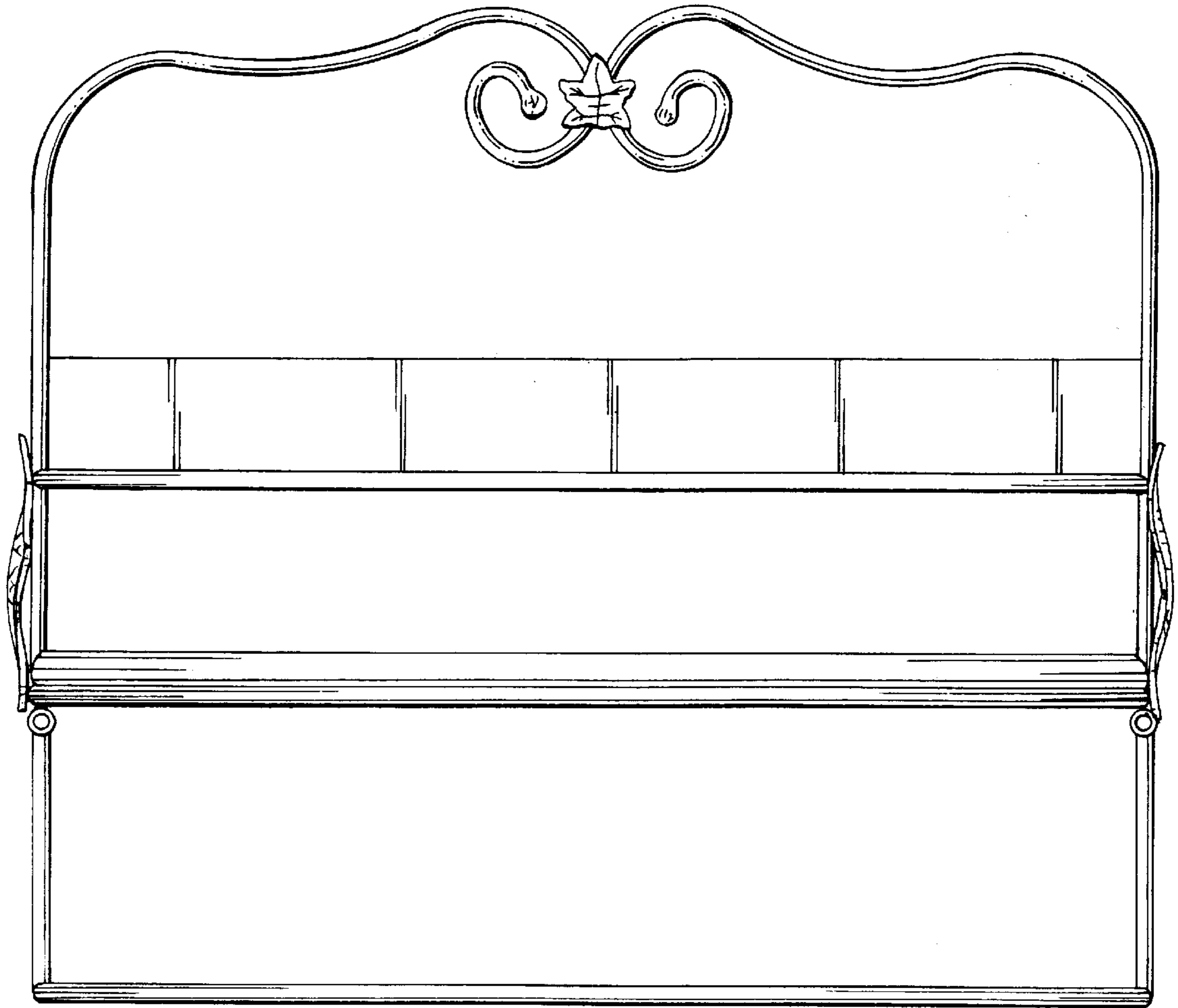

Fig. 8

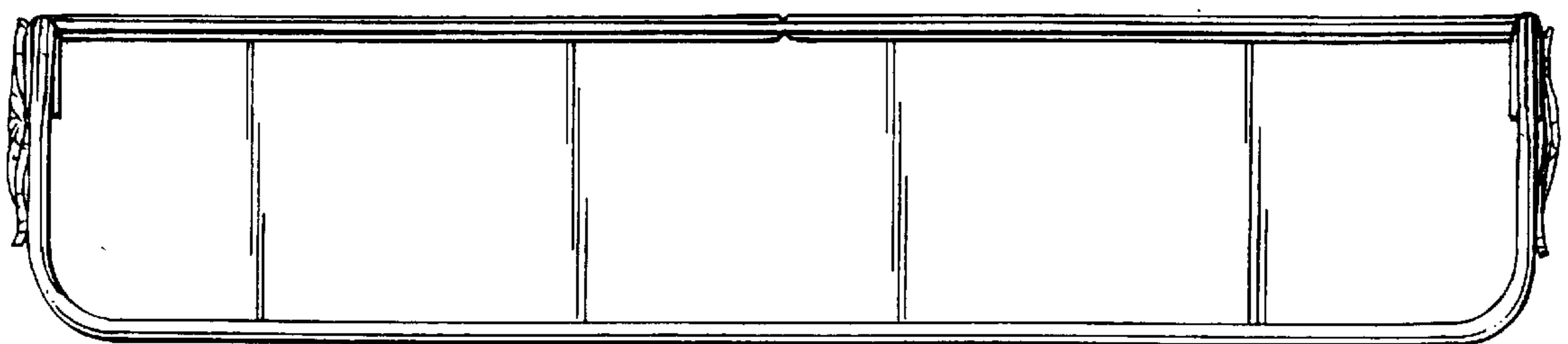

Fig. 9

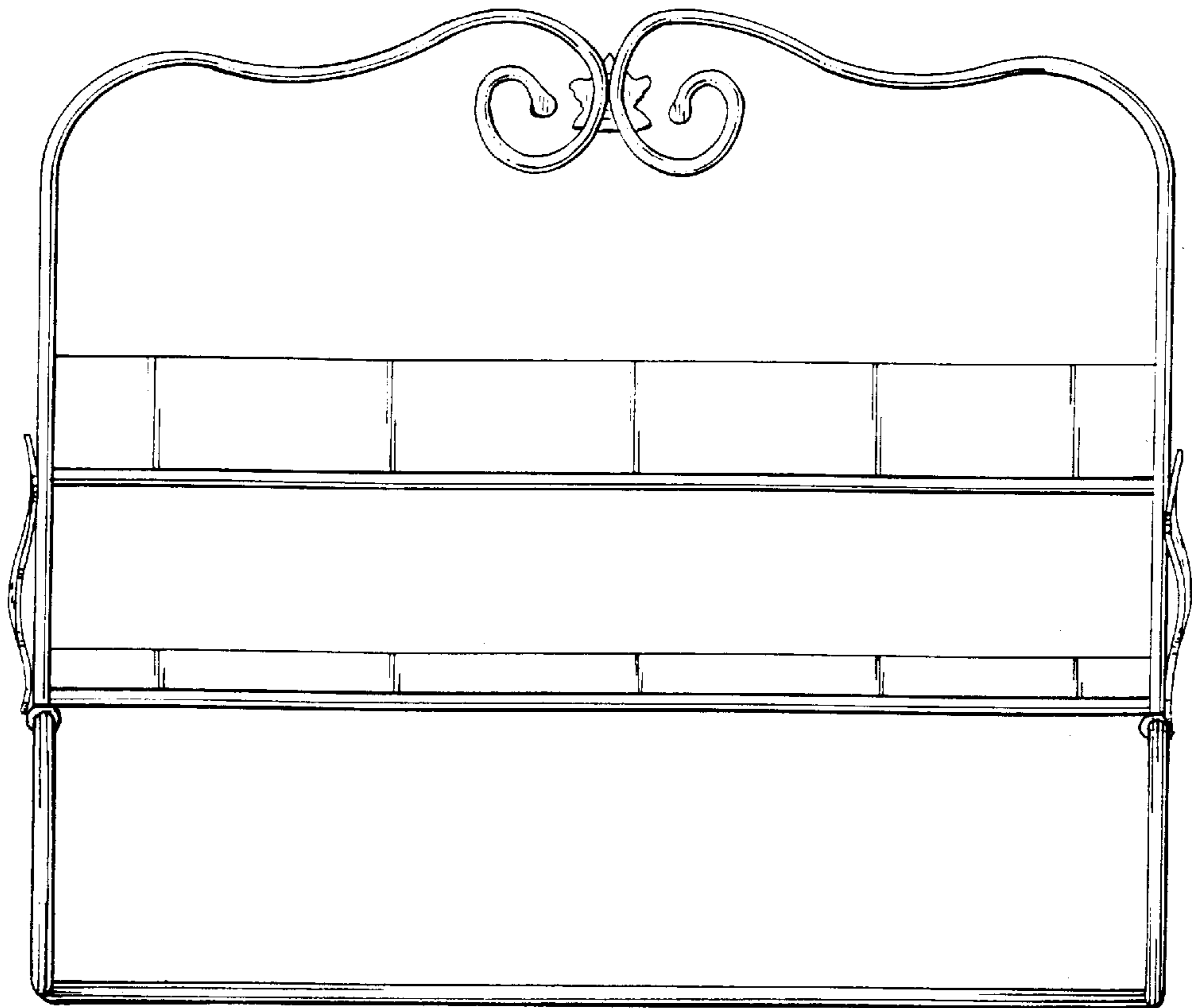

Fig. 10

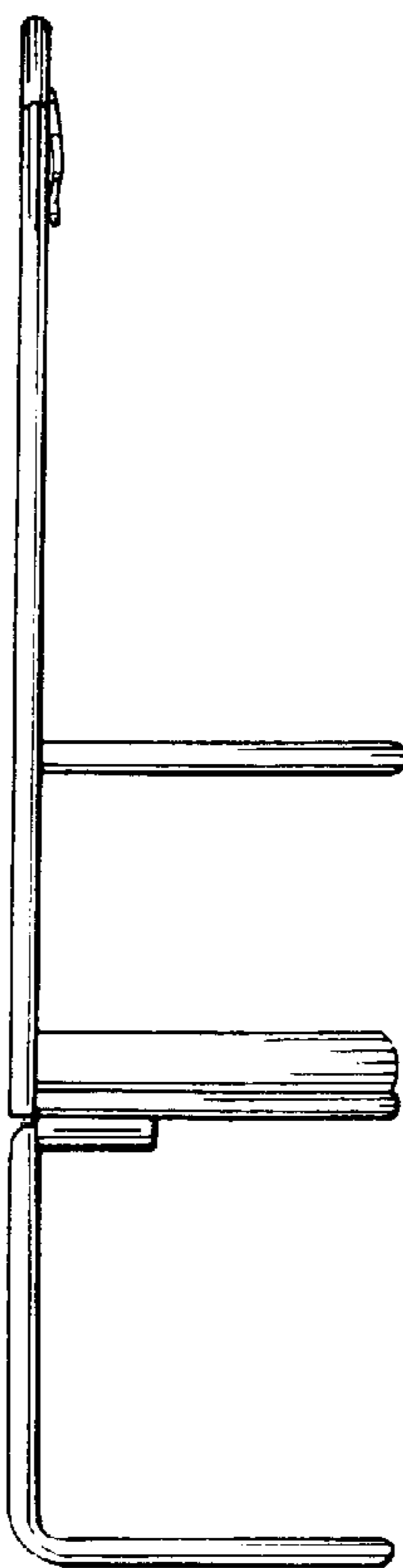

Fig. 11