



US00D397759S

**United States Patent** [19]  
**Cox**

[11] **Patent Number:** **Des. 397,759**  
[45] **Date of Patent:** **\*\*Sep. 1, 1998**

[54] **FISHING LURE**

[76] **Inventor:** **D. Blake Cox**, 5385 Valleydale Rd.,  
Kernersville, N.C. 27284

[\*\*] **Term:** **14 Years**

[21] **Appl. No.:** **43,814**

[22] **Filed:** **Sep. 13, 1995**

[51] **LOC (6) Cl.** ..... **22-05**

[52] **U.S. Cl.** ..... **D22/129**

[58] **Field of Search** ..... D22/126, 128,  
D22/129; 43/42.43, 42.14, 42.11, 42.13,  
42.15, 42.16, 42.17, 42.18, 42.19, 42.37,  
92.5

[56] **References Cited**

**U.S. PATENT DOCUMENTS**

10,771	4/1854	Buell	43/42.5
1,890,400	12/1932	Miller	43/42.43
2,255,222	9/1941	Leusch	43/42.43
2,319,686	5/1943	Janisch	43/42.43
2,462,437	2/1949	Tallaksen	43/42.43
2,895,252	7/1959	Tibbetts	43/42.5
3,395,480	8/1968	McPherson	43/42.43

**FOREIGN PATENT DOCUMENTS**

509819	2/1955	Canada	D22/129
439134	11/1935	United Kingdom	43/42.19
665139	1/1952	United Kingdom	D22/129

**OTHER PUBLICATIONS**

Pflueger Fishing Tackle, p. 94, ©1940, Washington Spinner.

*Primary Examiner*—Doris V. Coles

[57] **CLAIM**

The ornamental design for a fishing lure, as shown and described.

**DESCRIPTION**

FIG. 1 is a top plan view of a fishing lure, showing my new design;  
 FIG. 2 is a bottom plan view thereof;  
 FIG. 3 is a front elevational view thereof;  
 FIG. 4 is a rear elevational view thereof;  
 FIG. 5 is a right side elevational view thereof;  
 FIG. 6 is a right side elevational view with the hook rotated 180 degrees;  
 FIG. 7 is a top plan view of a second embodiment;  
 FIG. 8 is a bottom plan view thereof;  
 FIG. 9 is a front elevational view thereof;  
 FIG. 10 is a rear elevational view thereof;  
 FIG. 11 is a right side elevational view thereof;  
 FIG. 12 is a right side elevational view with the hook and weed guard rotated 180 degrees;  
 FIG. 13 is a top plan view of a third embodiment;  
 FIG. 14 is a bottom plan view thereof;  
 FIG. 15 is a front elevational view thereof;  
 FIG. 16 is a rear elevational view thereof;  
 FIG. 17 is a right side elevational view thereof;  
 FIG. 18 is a right side elevational view with the hook rotated 180 degrees;  
 FIG. 19 is a top plan view of a fourth embodiment;  
 FIG. 20 is a bottom plan view thereof;  
 FIG. 21 is a front elevational view thereof;  
 FIG. 22 is a rear elevational view thereof;  
 FIG. 23 is a right side elevational view thereof; and,  
 FIG. 24 is a right side elevational view with the hook and weed guard rotated 180 degrees.

**1 Claim, 4 Drawing Sheets**

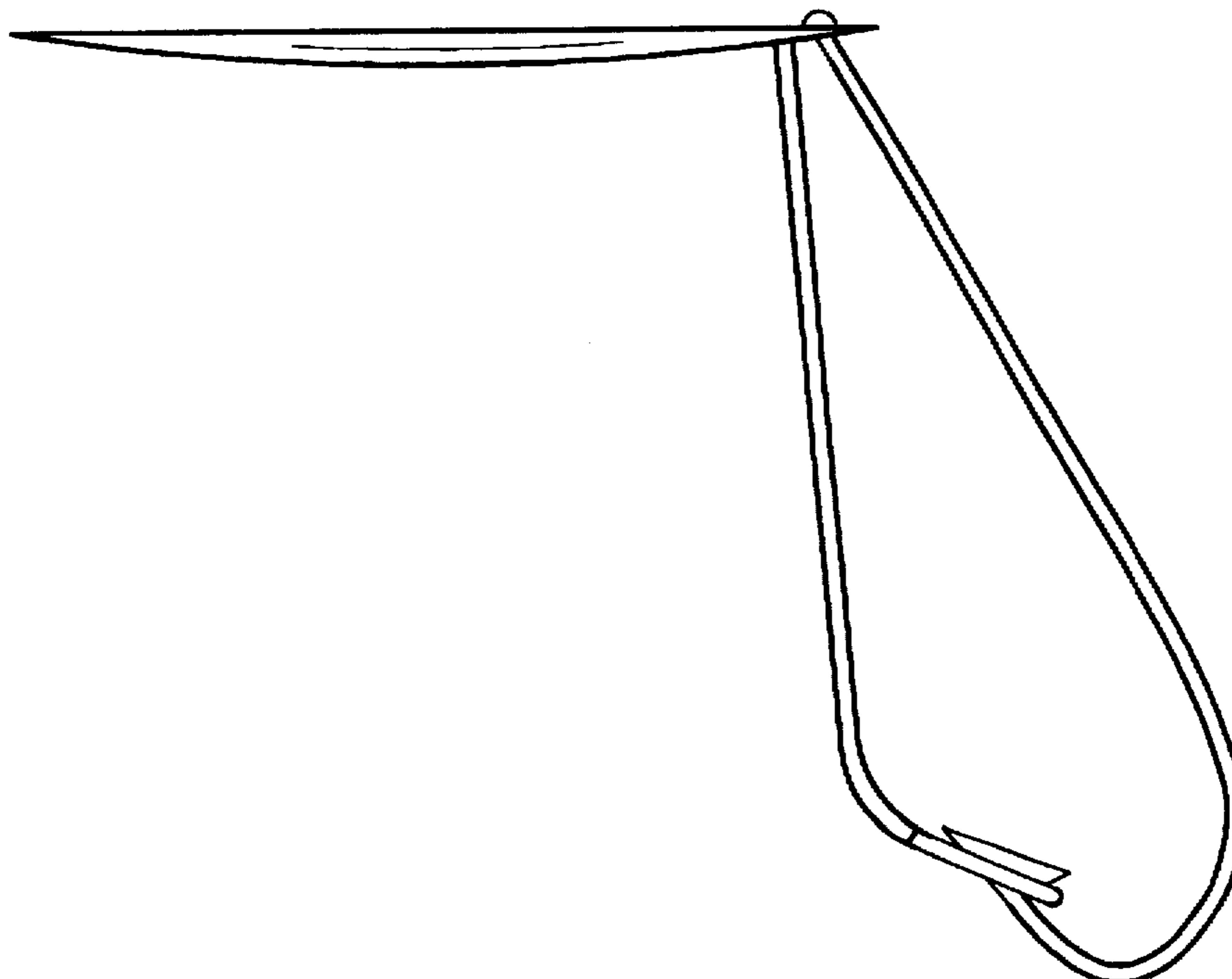

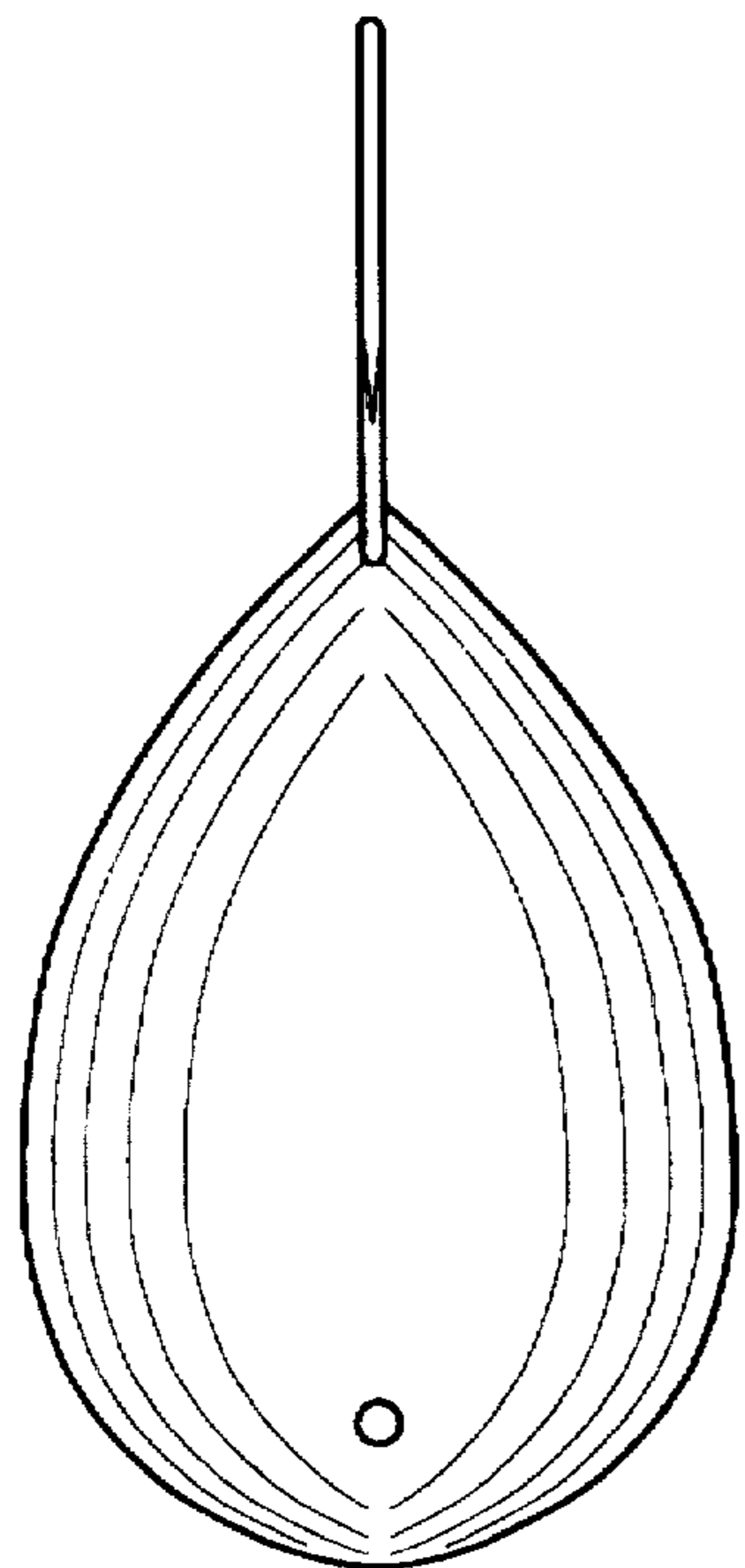
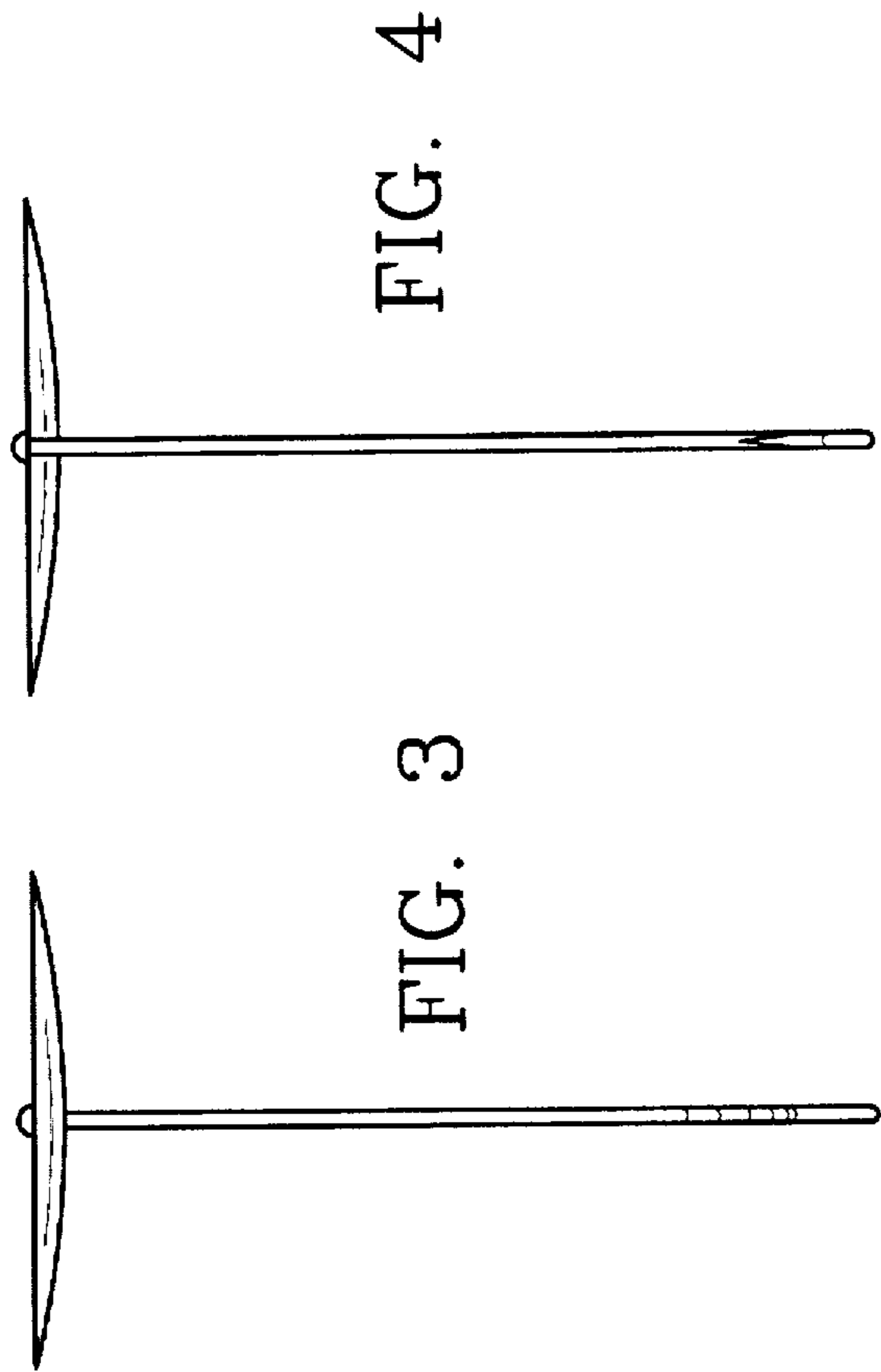
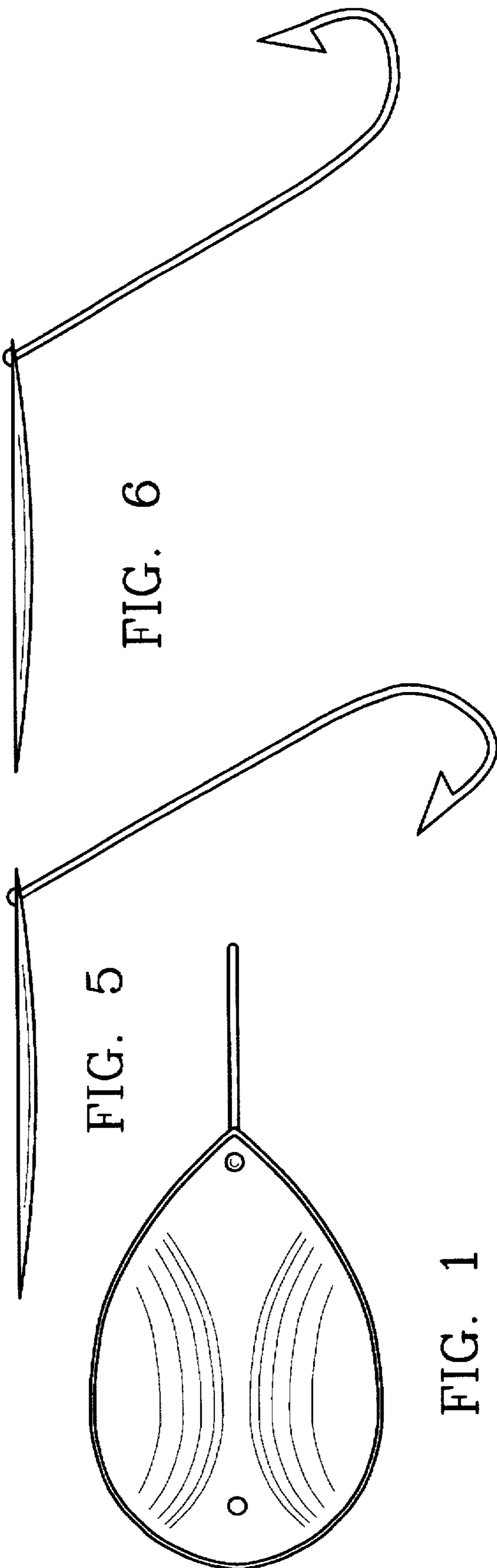

FIG. 2



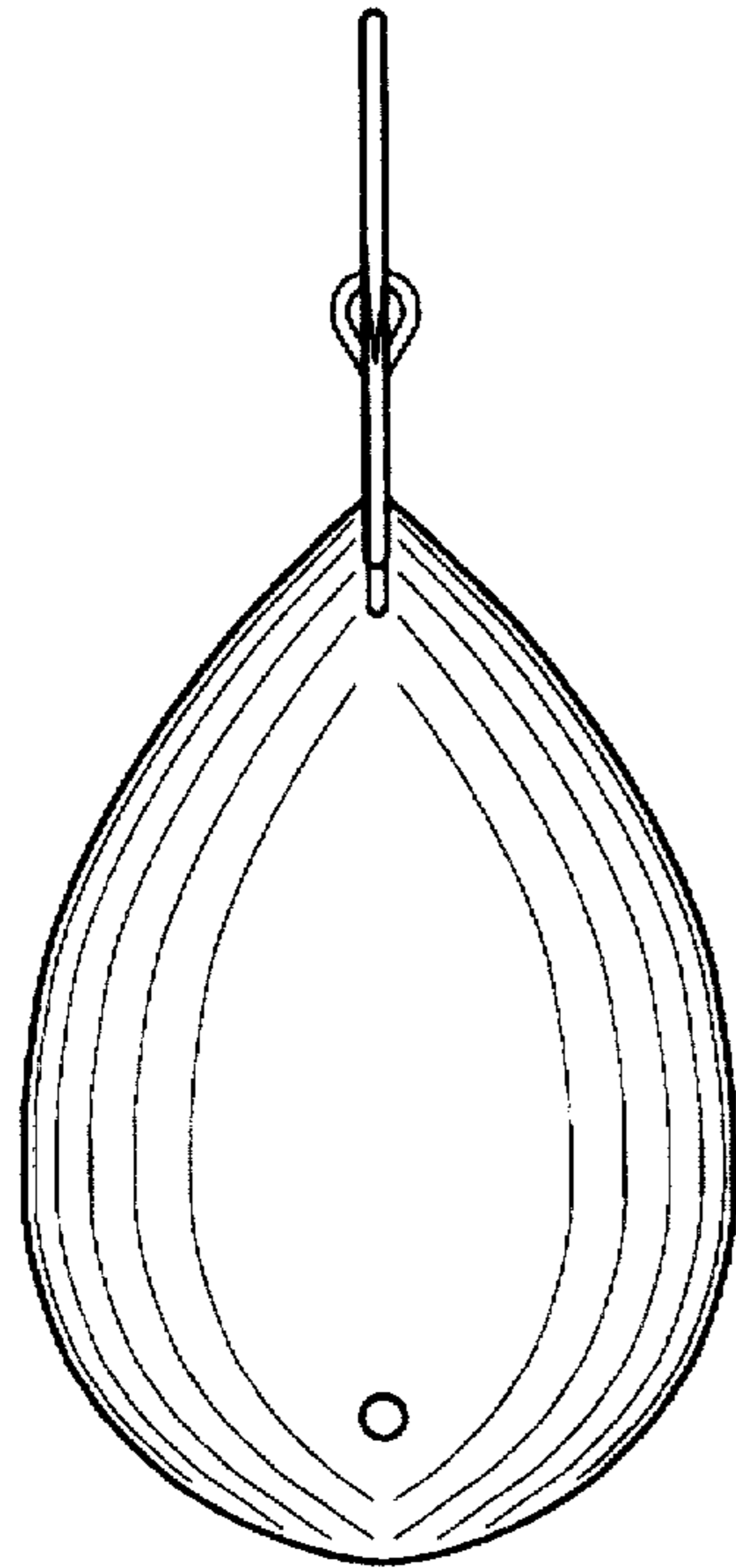

FIG. 8

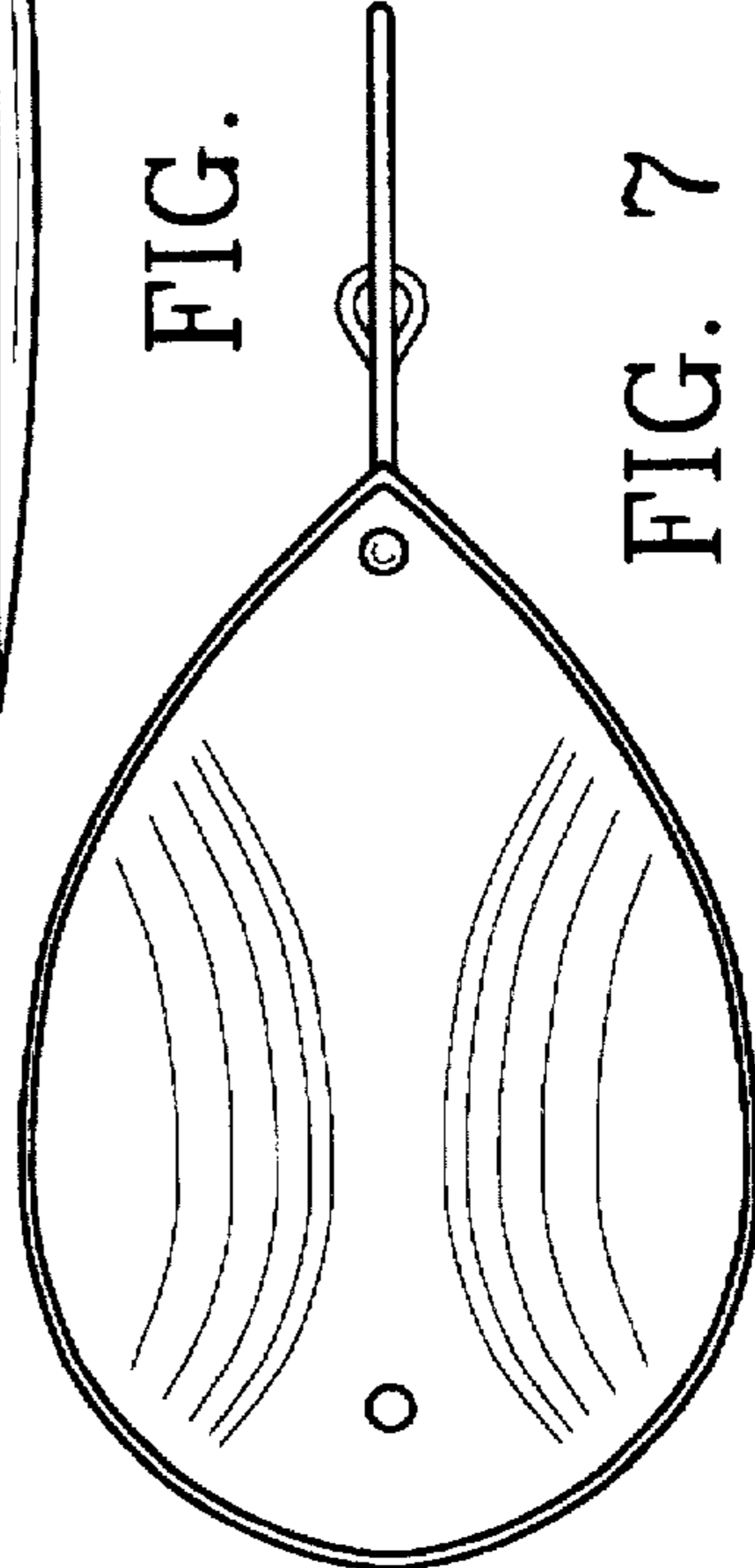

FIG. 7

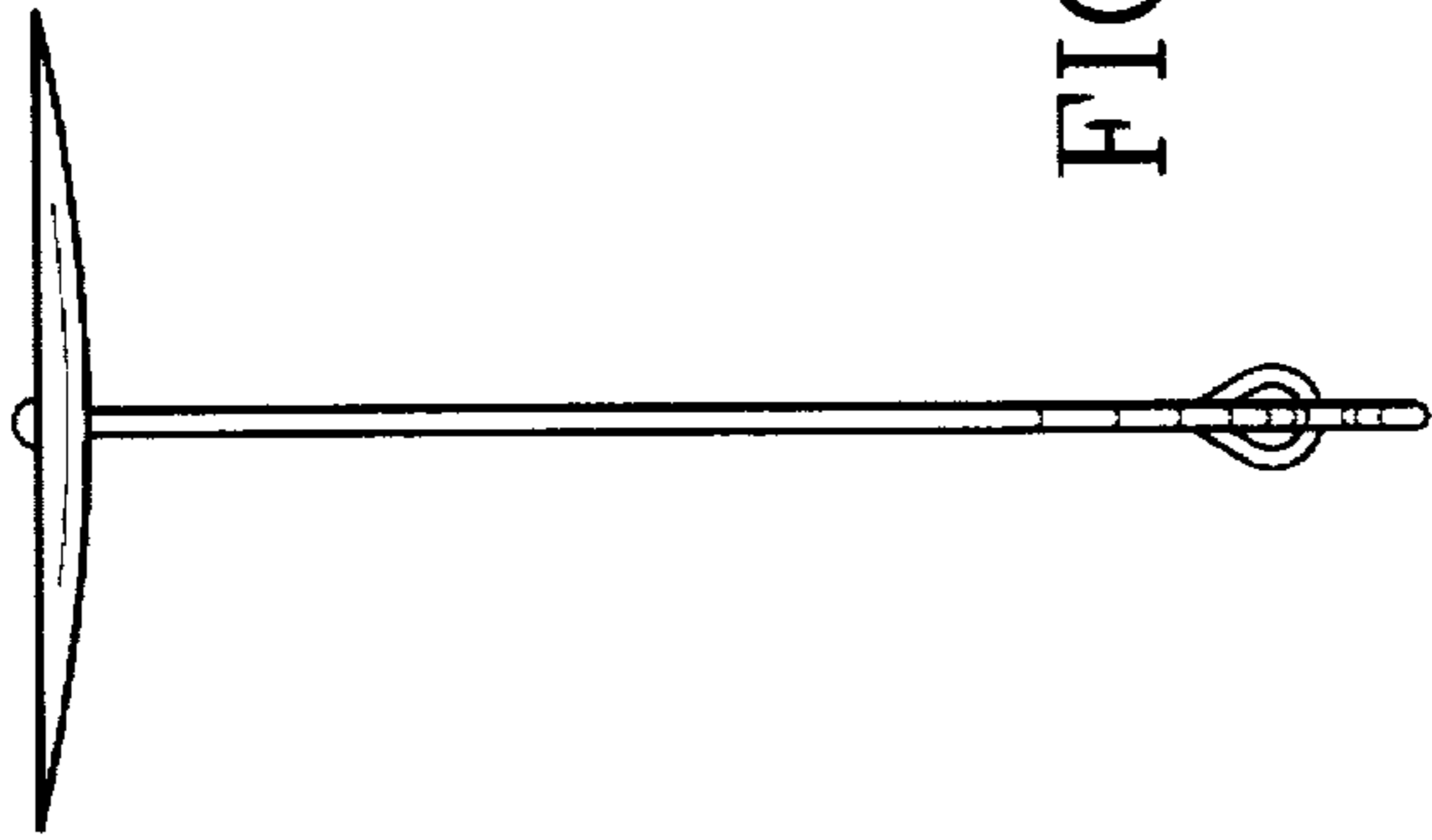

FIG. 9

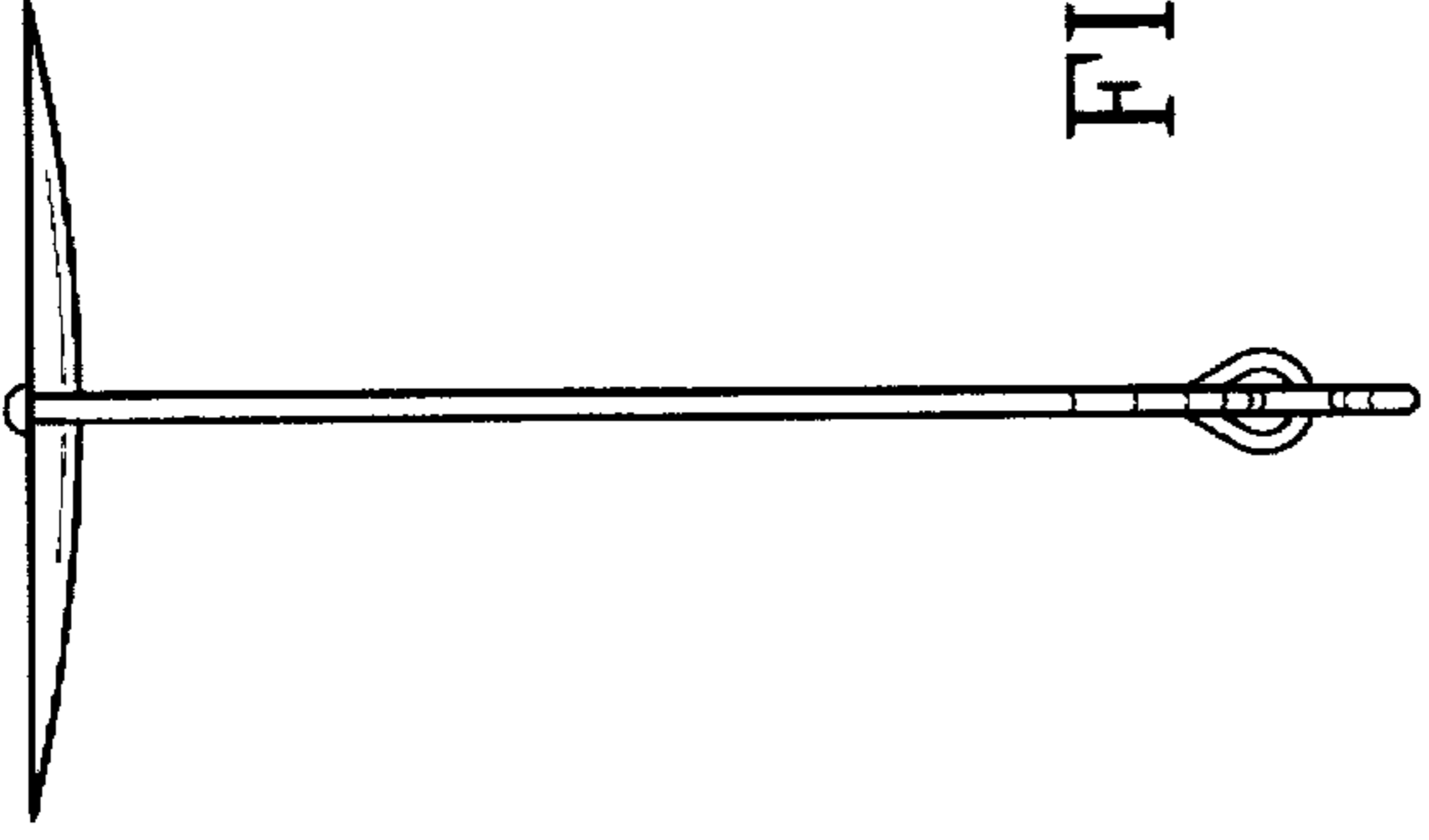

FIG. 10

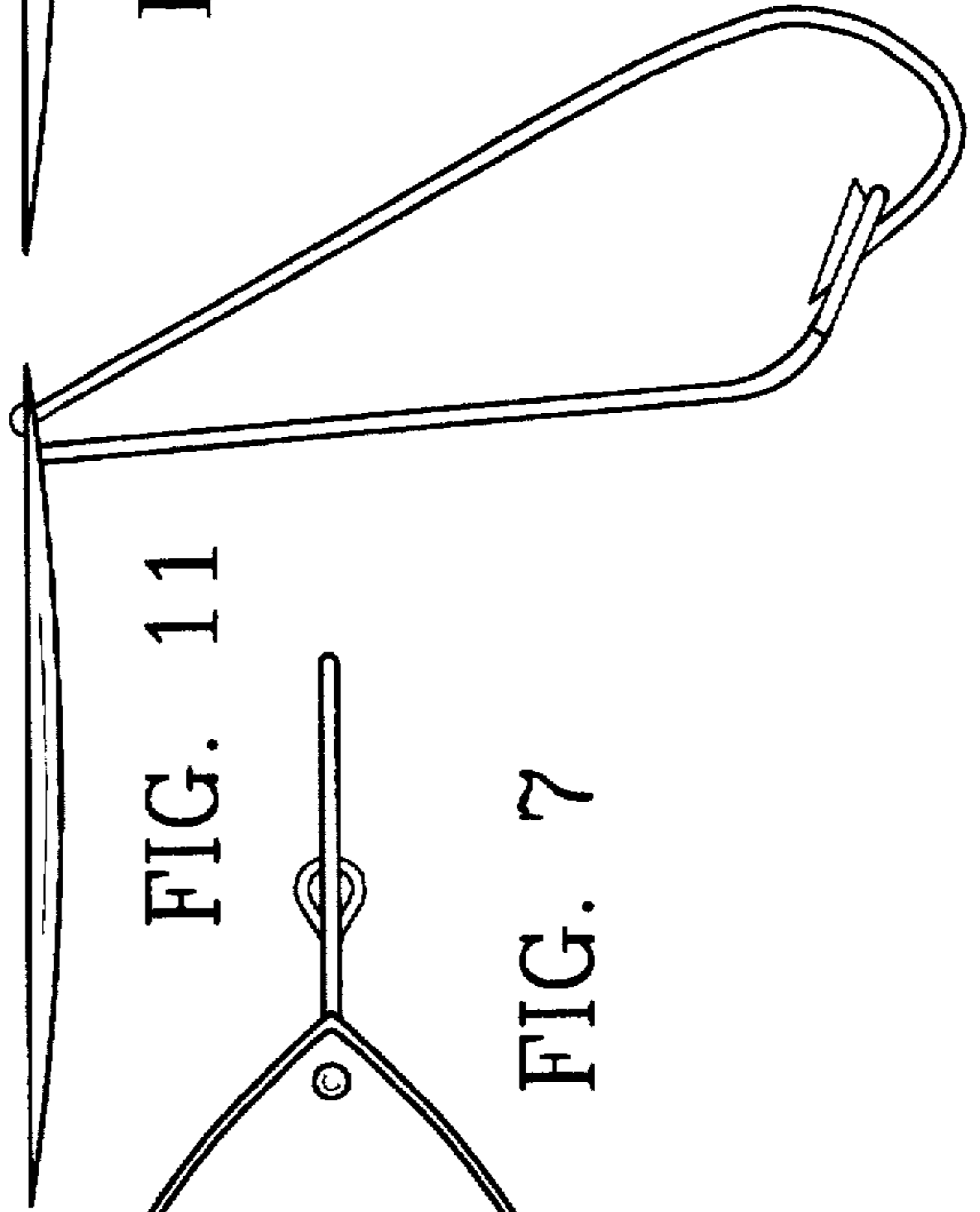

FIG. 11

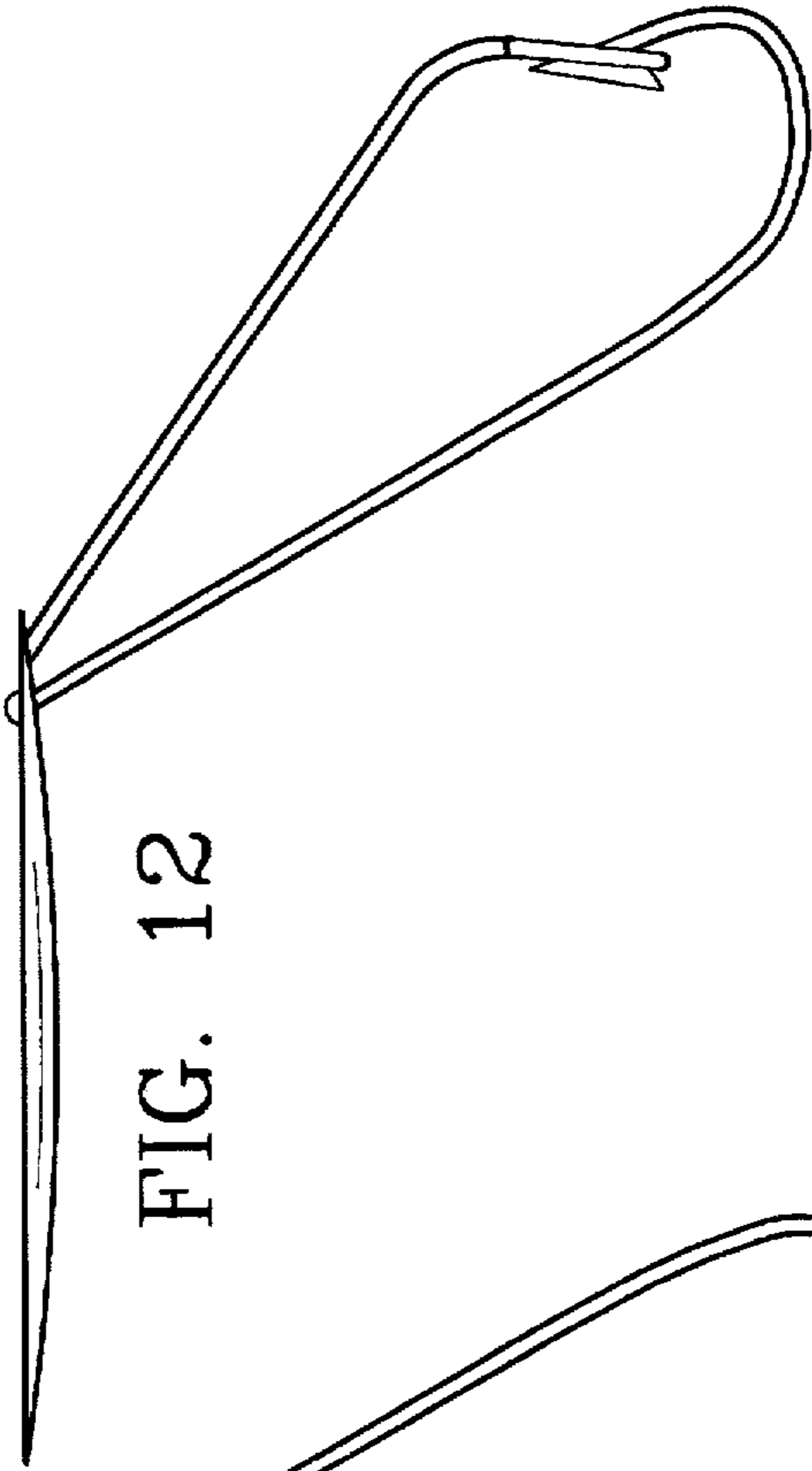

FIG. 12

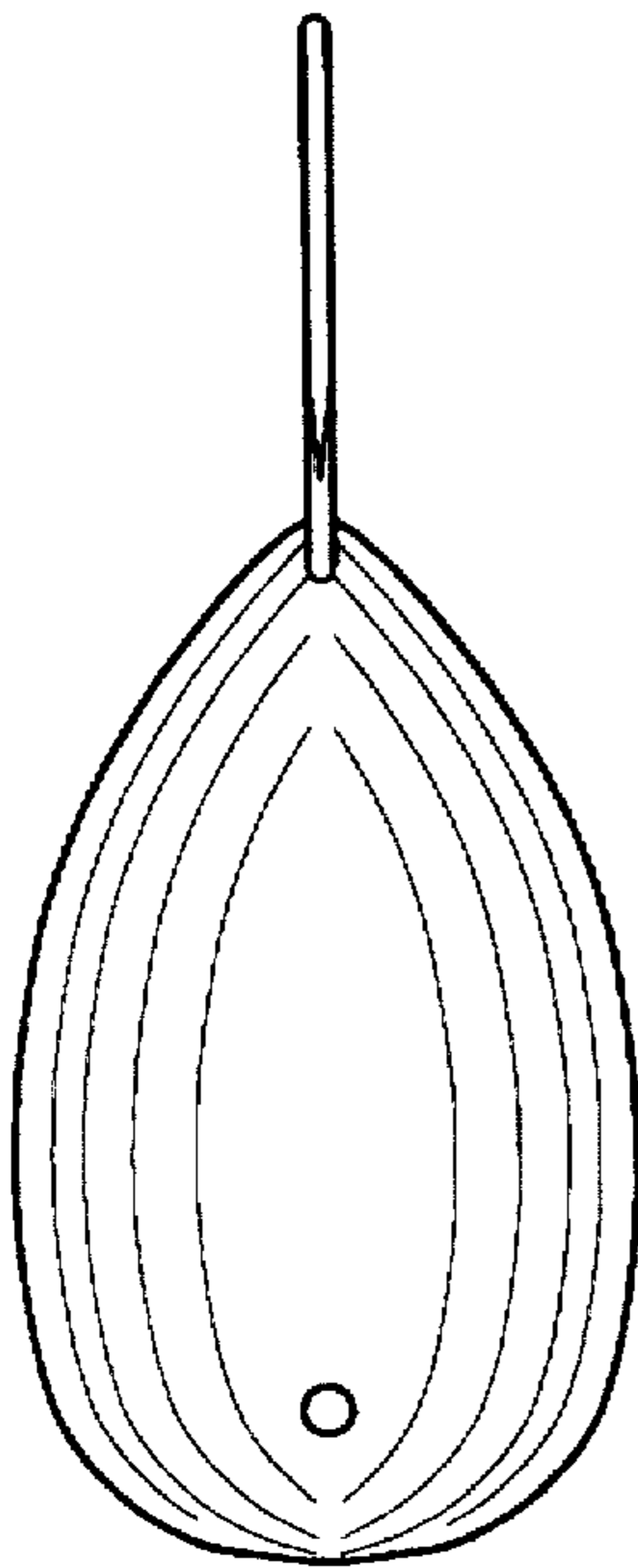

FIG. 14

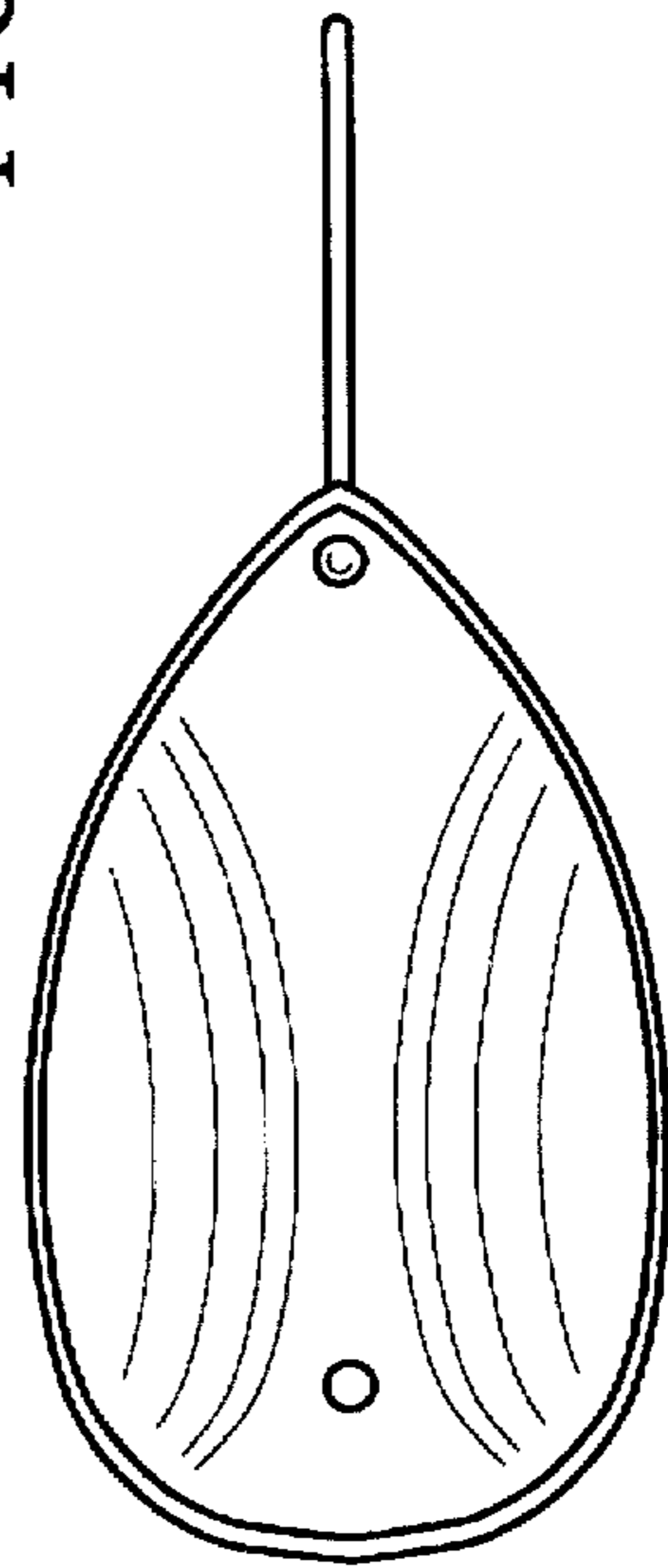

FIG. 13

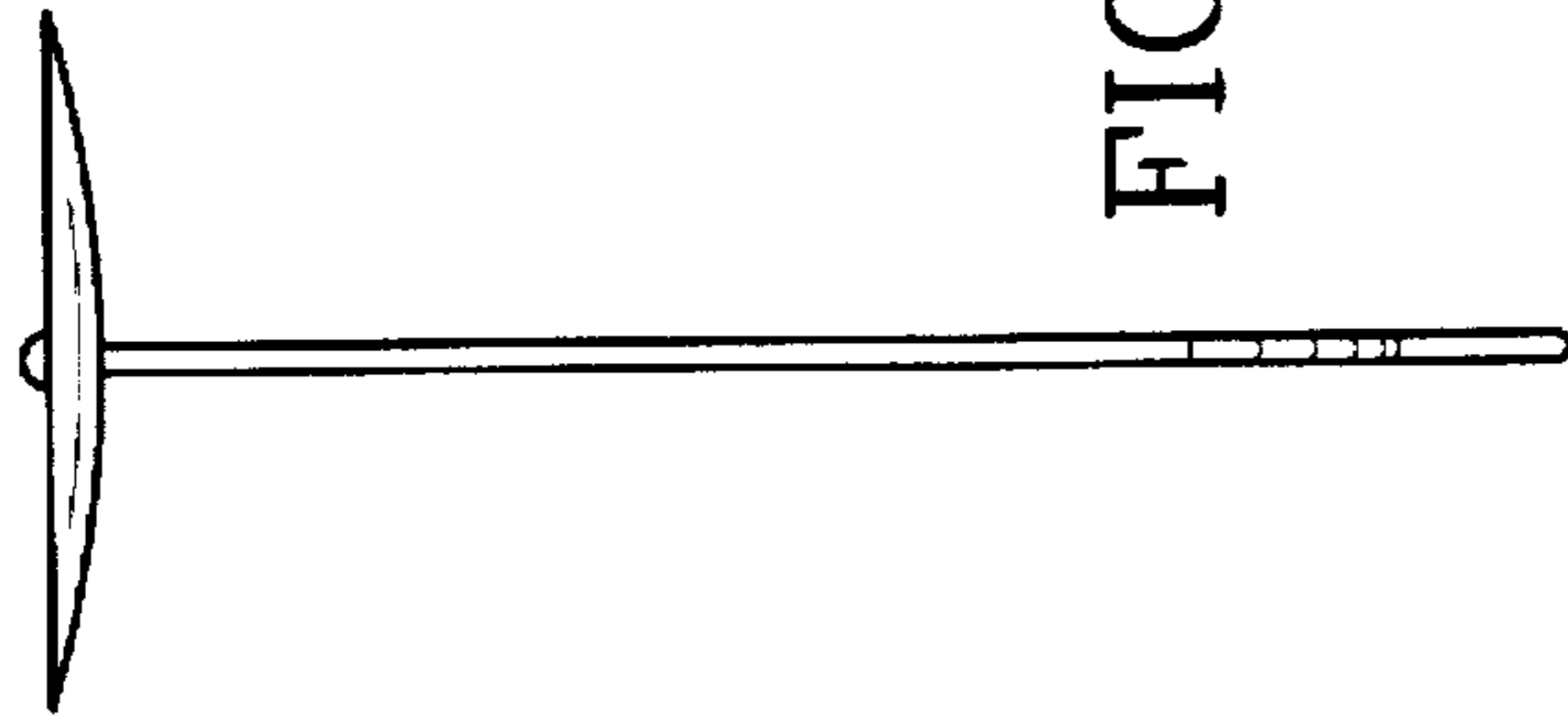

FIG. 15

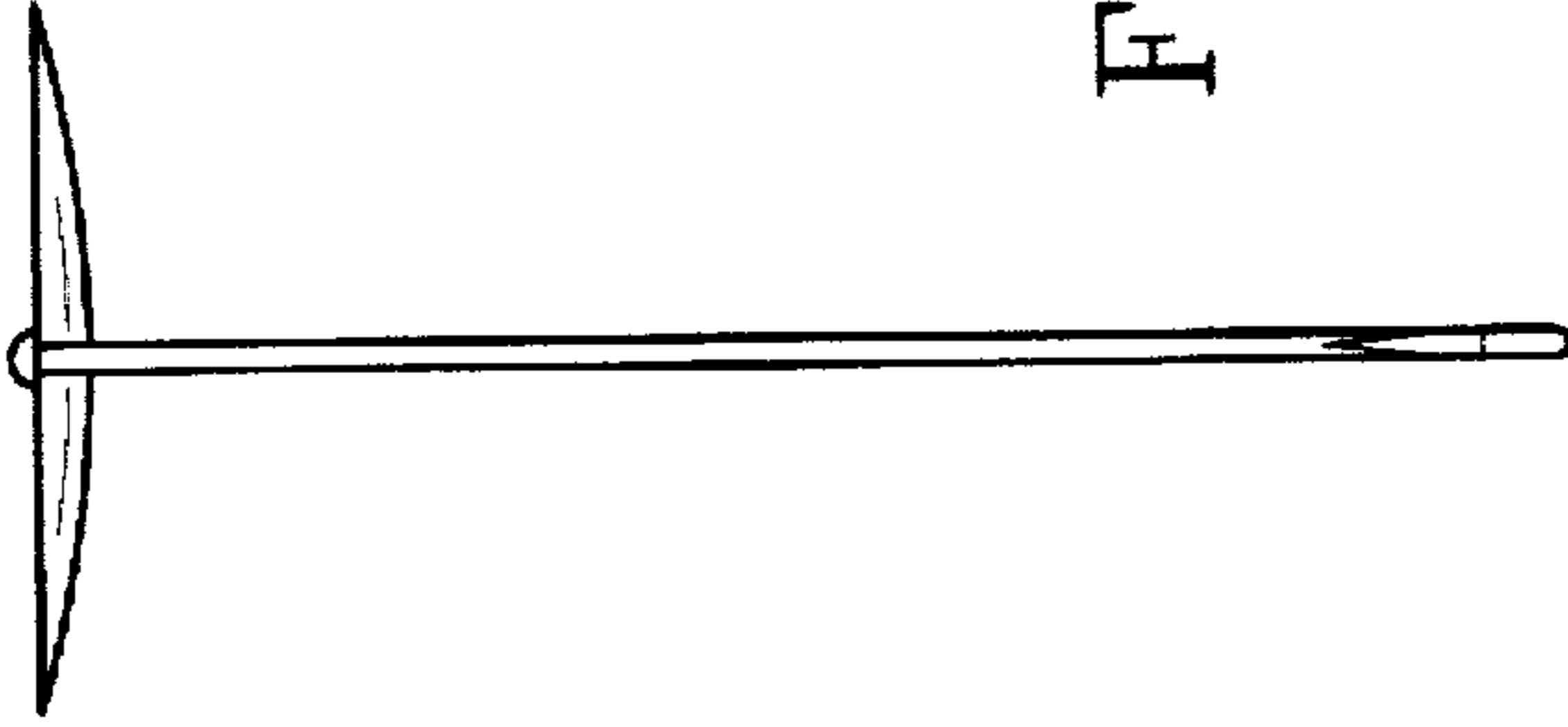

FIG. 16

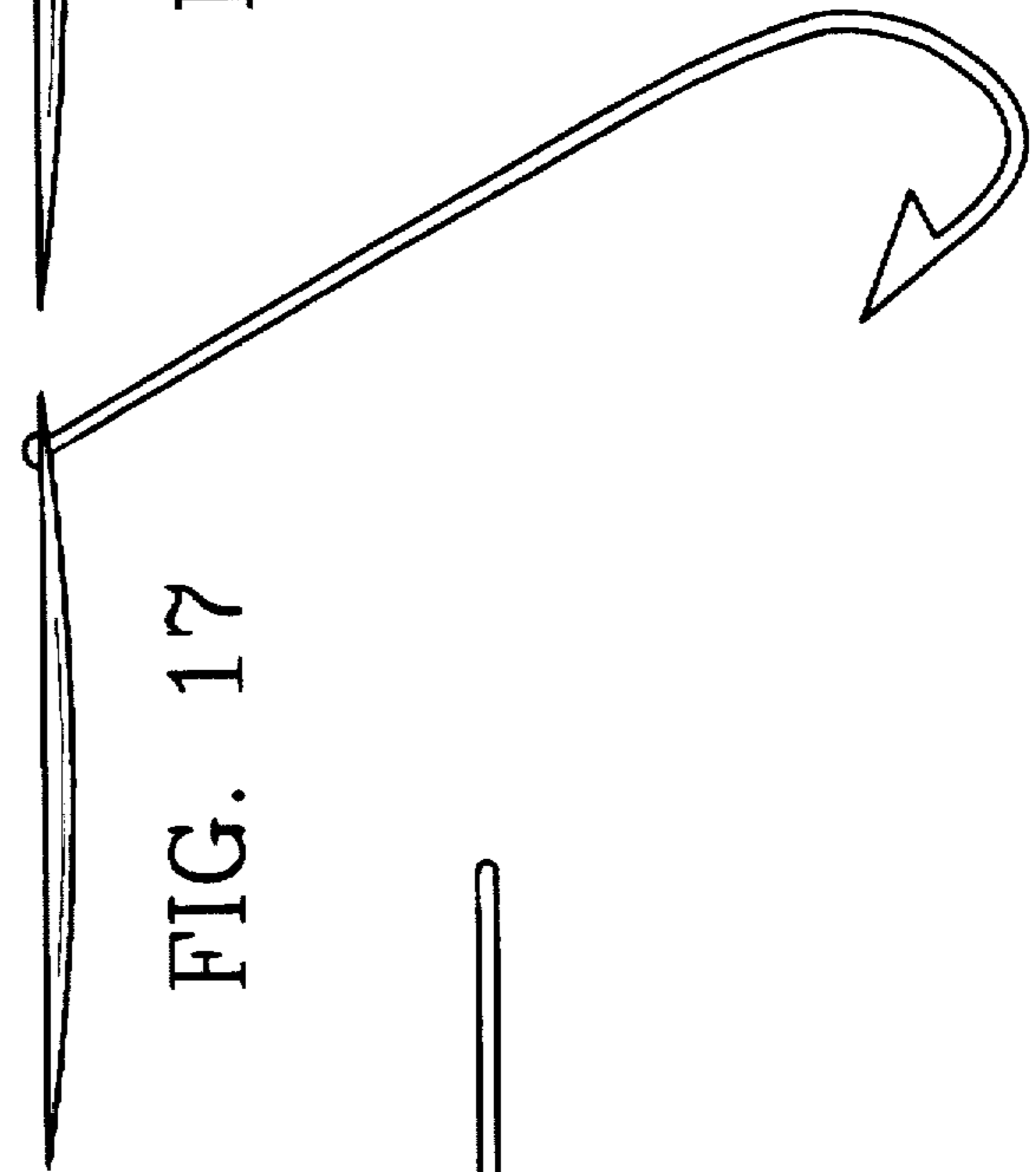

FIG. 17

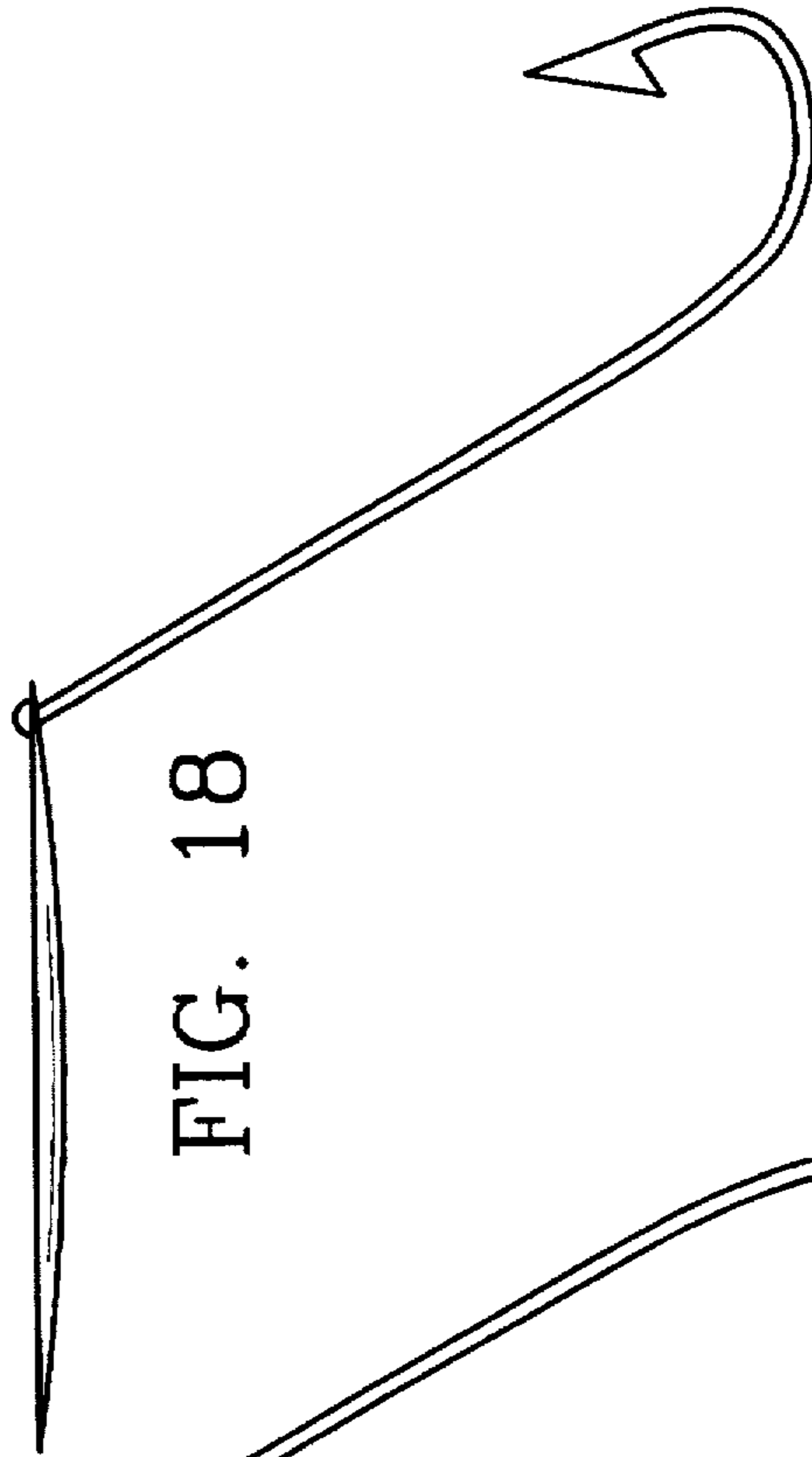

FIG. 18

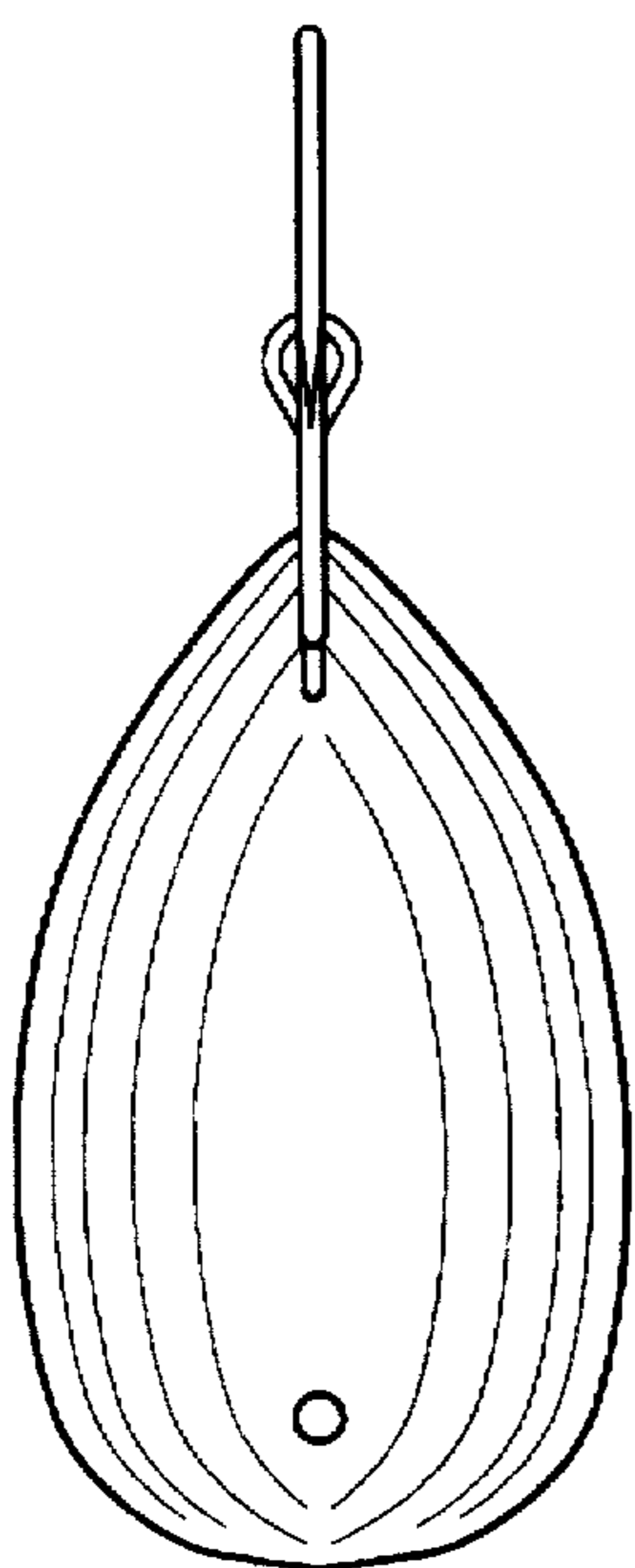

FIG. 20

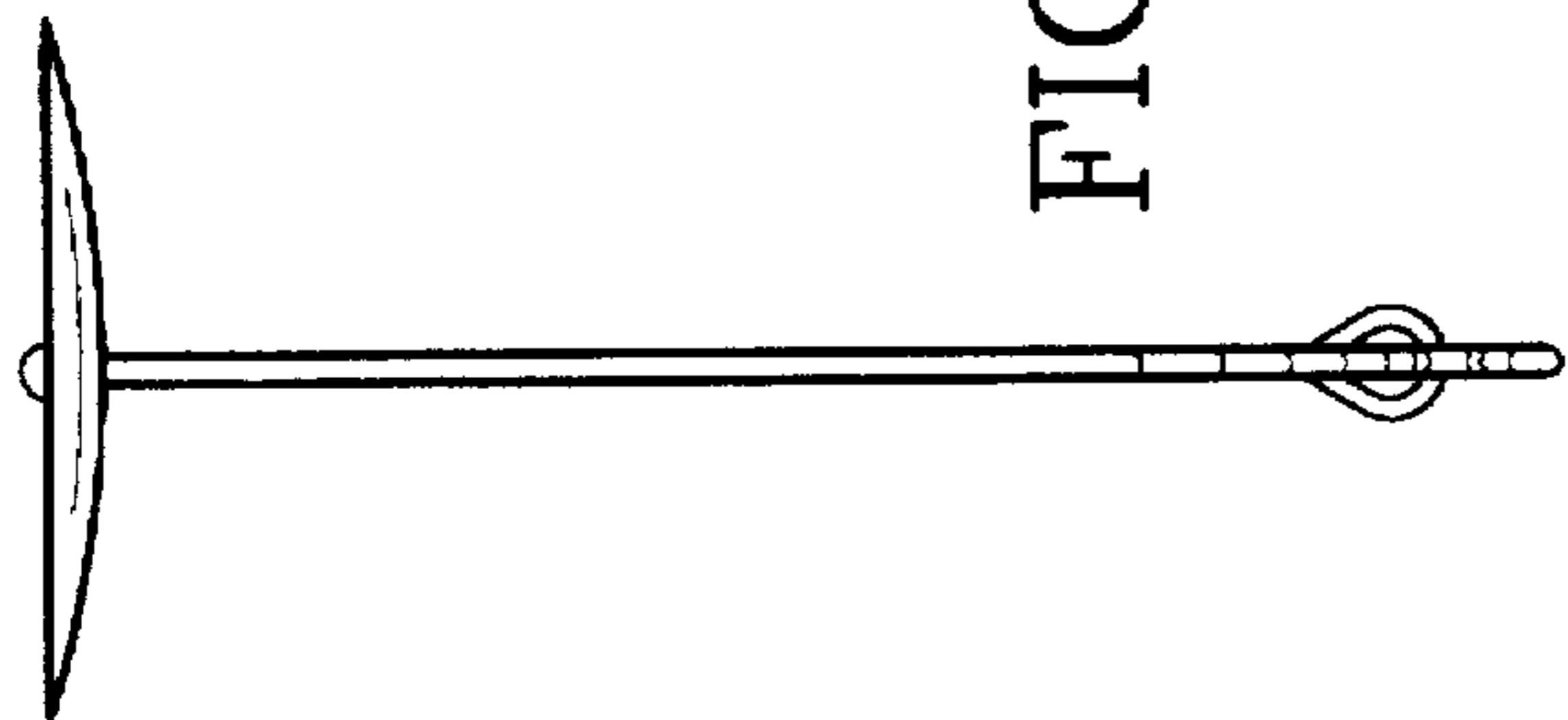

FIG. 21

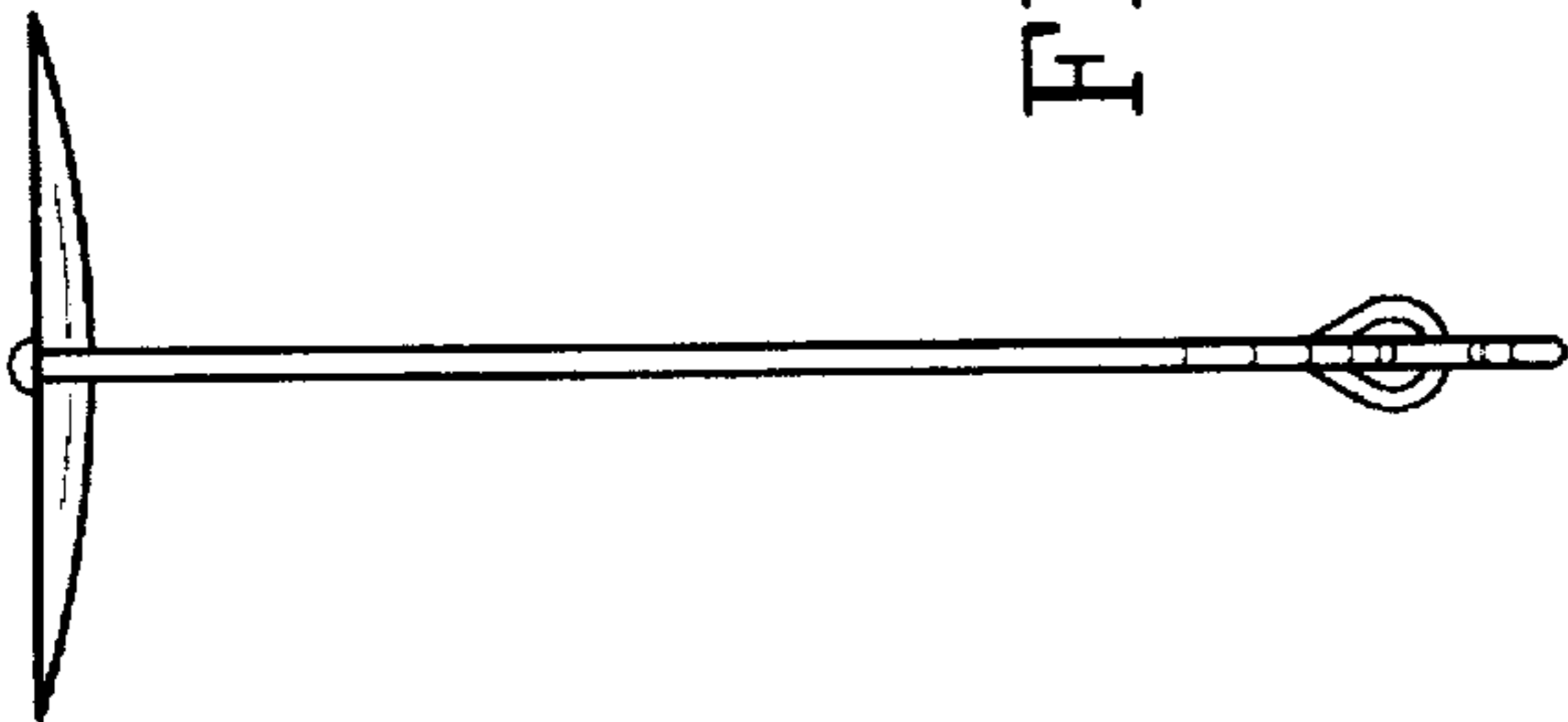

FIG. 22

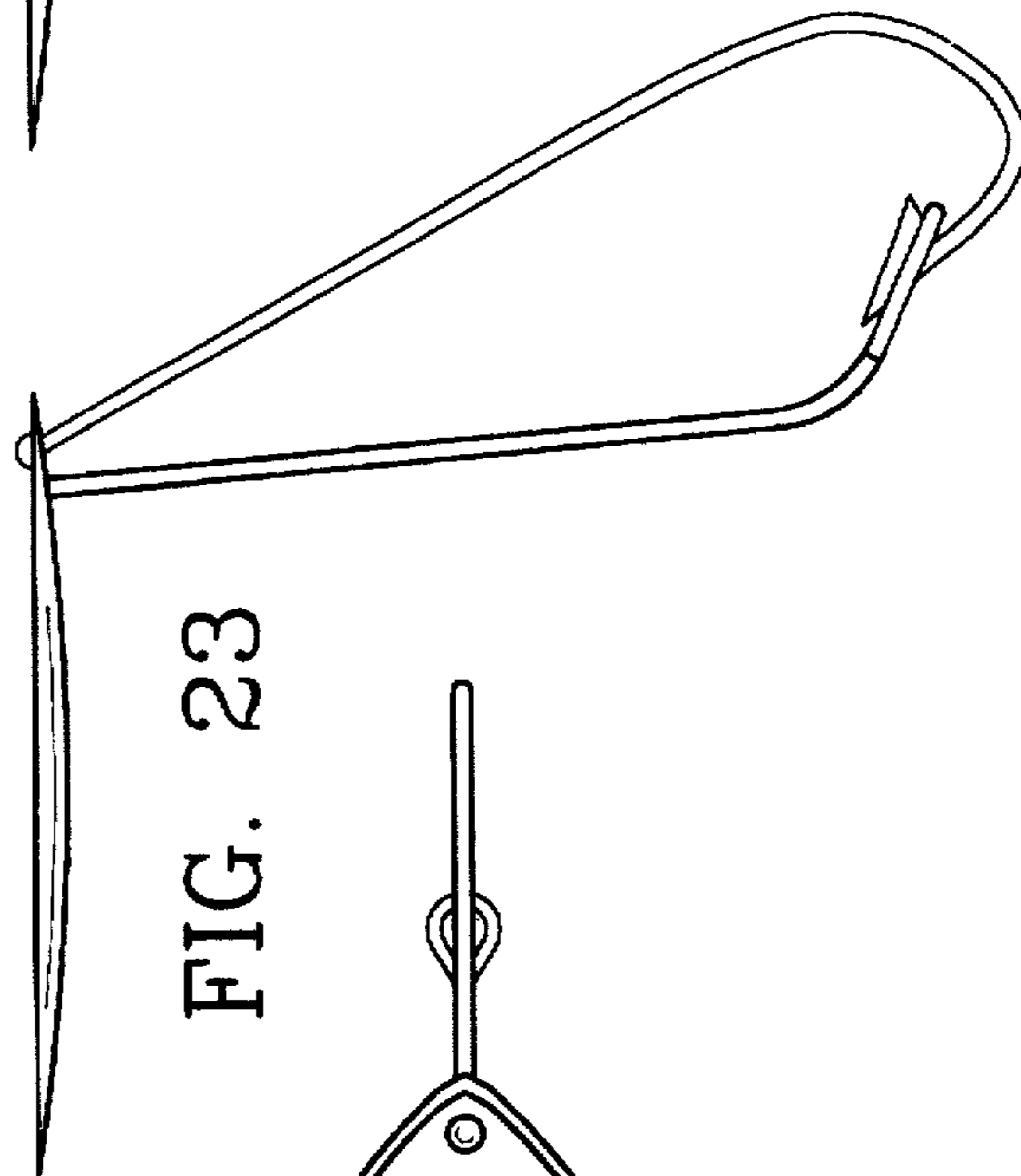

FIG. 23

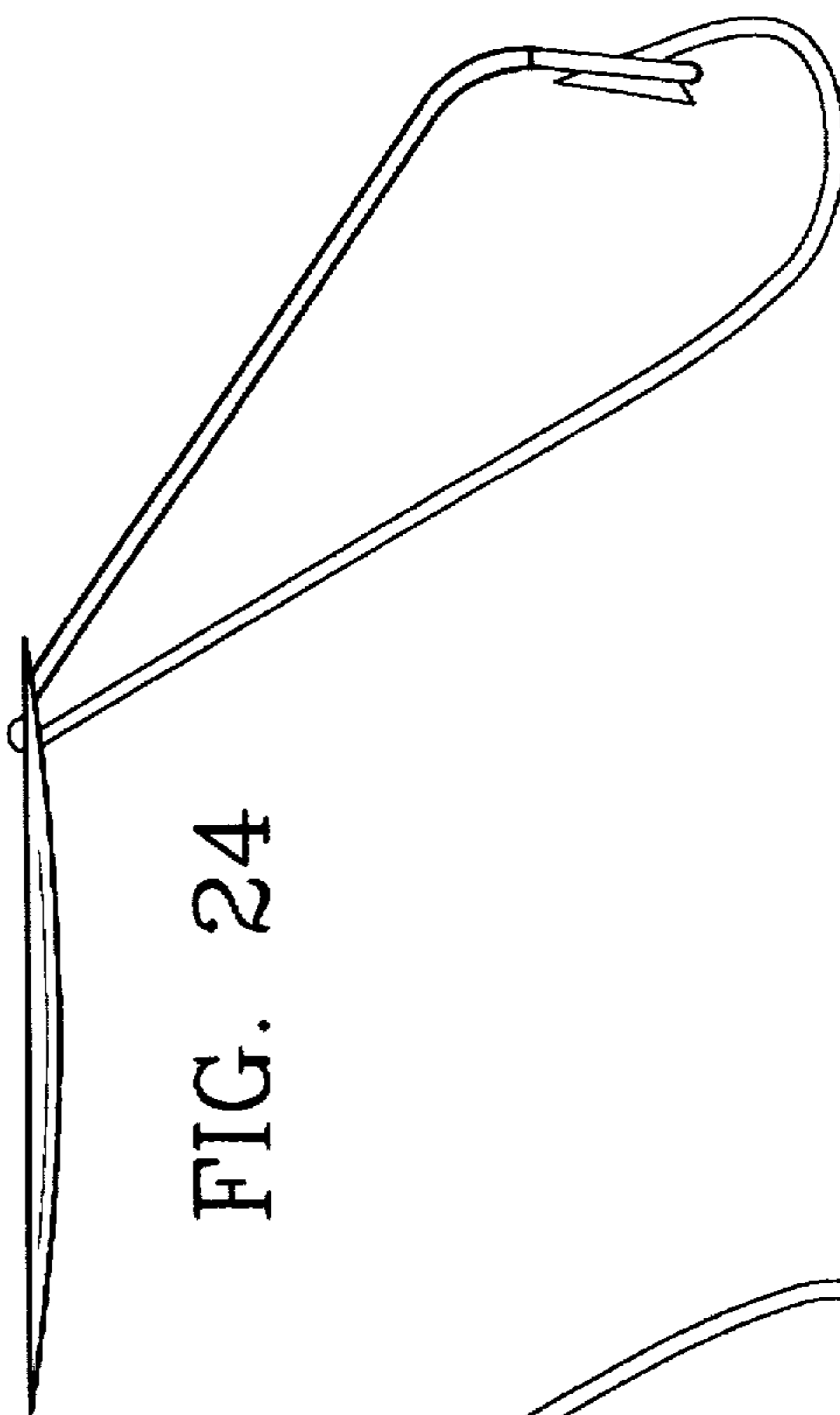

FIG. 24

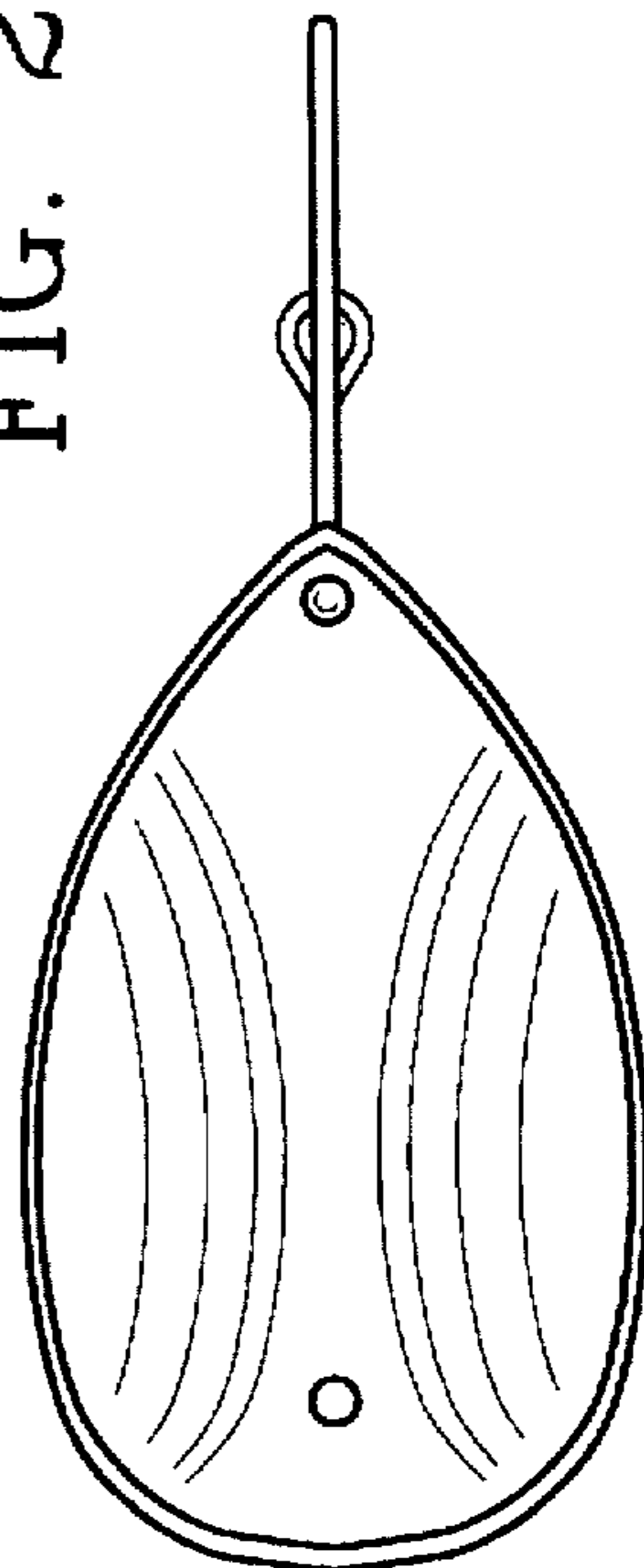

FIG. 19