

U.S. PATENT DOCUMENTS

4,840,390 6/1989 Lockard et al. .
4,887,830 12/1989 Fought et al. .
4,981,305 1/1991 Lockard et al. .
4,989,890 2/1991 Lockard et al. .
5,033,793 7/1991 Quintile .
5,094,310 3/1992 Richey et al. .
5,121,938 6/1992 Gross et al. .
5,145,020 9/1992 Quintile et al. .
5,154,251 10/1992 Fought .
5,170,826 12/1992 Carstensen et al. .
5,195,803 3/1993 Quintile .
5,203,610 4/1993 Miller .
5,263,728 11/1993 Patel et al. .
5,294,141 3/1994 Mentessi et al. .
5,366,037 11/1994 Richey .
5,378,045 1/1995 Siekman et al. .
5,442,823 8/1995 Siekman et al. .

OTHER PUBLICATIONS

6 page price list entitled "Are You Looking for a New Electric Wheelchair?" by Battery Chairs Limited, 24/26 Old Meeting Road, Coseley, West Midlands WV14 8HB, United Kingdom.

2 page flyer entitled "Little Dipper".

2 page flyer entitled "Boing! Colours by Permobil".

2 page flyer entitled "Eclipse Colours 'N Motion!".

2 page flyer entitled "Impact Colours 'N Motion!".

2 page "OrderForm" entitled Colours by Permobil for The Avenger.

2 page "OrderForm" entitled Colours by Permobil for The Boing!.

2 page "OrderForm" entitled Colours by Permobil for The Supernova Xtreme.

2 page "OrderForm" entitled Colours by Permobil for The Eclipse.

2 page "OrderForm" entitled Colours by Permobil for The G-Force.

2 page "OrderForm" entitled Colours by Permobil for The Impact.

2 page "OrderForm" entitled Colours by Permobil for The Little Dipper.

5 page brochure entitled "LaBac Introduces it's Tilt, ASB, and RSR on the Quickie P300 with 20" Wheels.

8 page order form entitled "Kid-Kart Cares About Kids".

2 page flyer entitled "Hoveround Personal Mobility Vehicles".

2 page flyer entitled "Chairman MPS Permobil Multi Position System".

2 page Permobil order form entitled "Chair.Man MINI FLEX".

2 page Permobil order form entitled "Chair.Man STANDER".

2 page Permobil order form entitled "Chair.Man MPS".

2 page Permobil order form entitled "Chair.Man CORPUS".

2 page Permobil order form entitled "Chair.Man ROBO".

2 page Permobil order form entitled "Chair.Man MINI STANDER".

1 page announcement entitled "Thank You for Your Interest in Permobil's Power Mobility Products!".

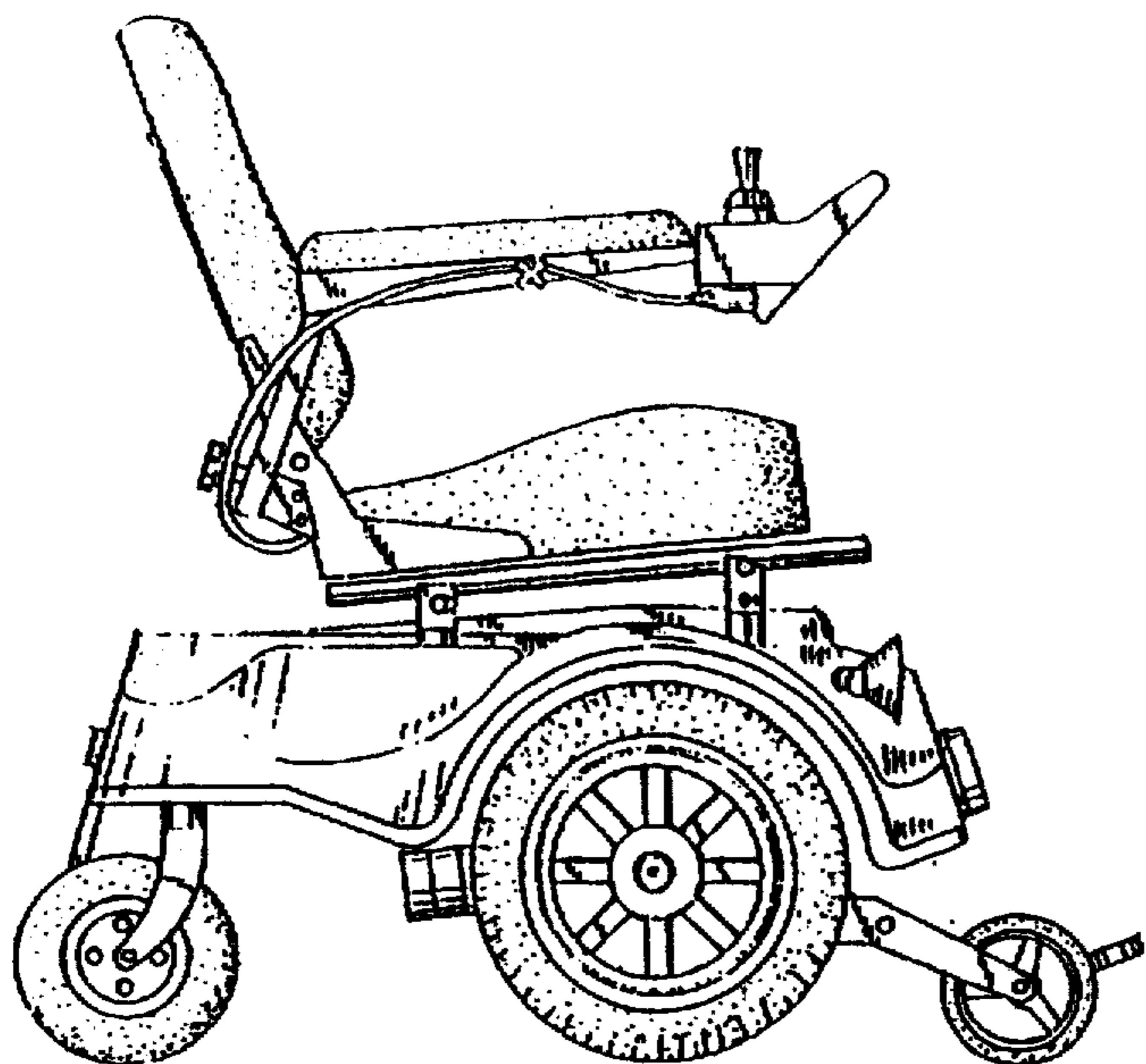

FIG. 1

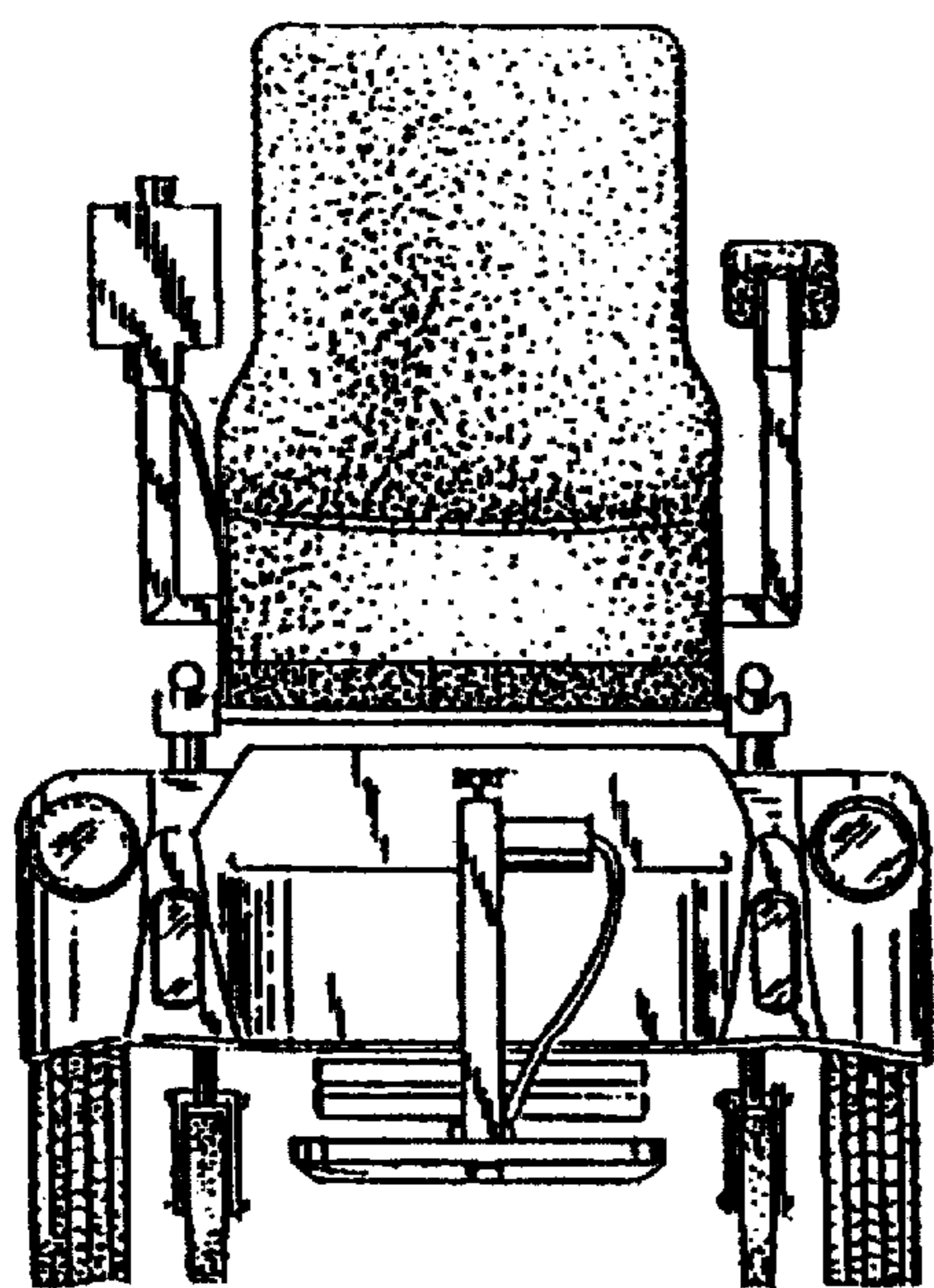

FIG. 2

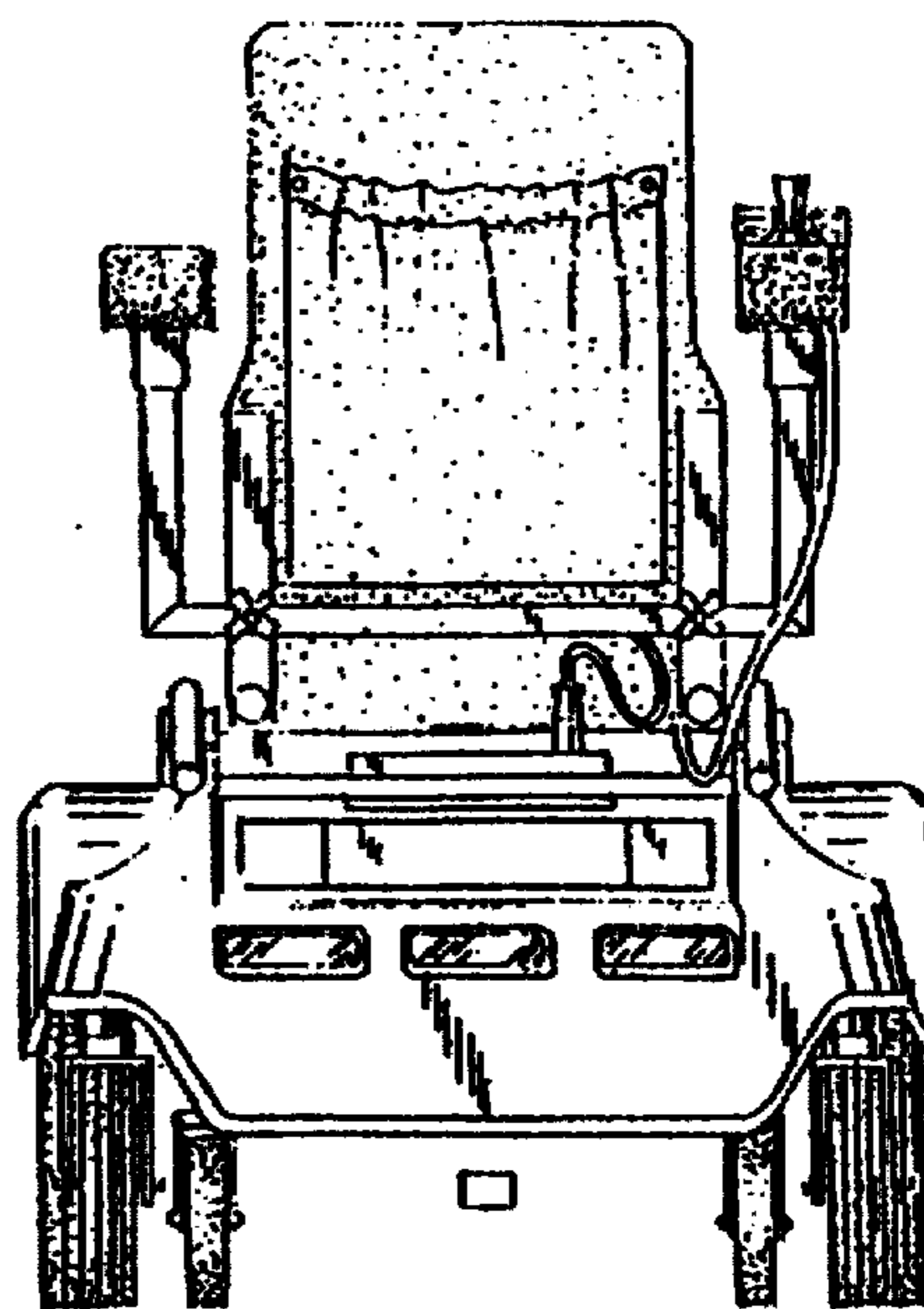

FIG. 3

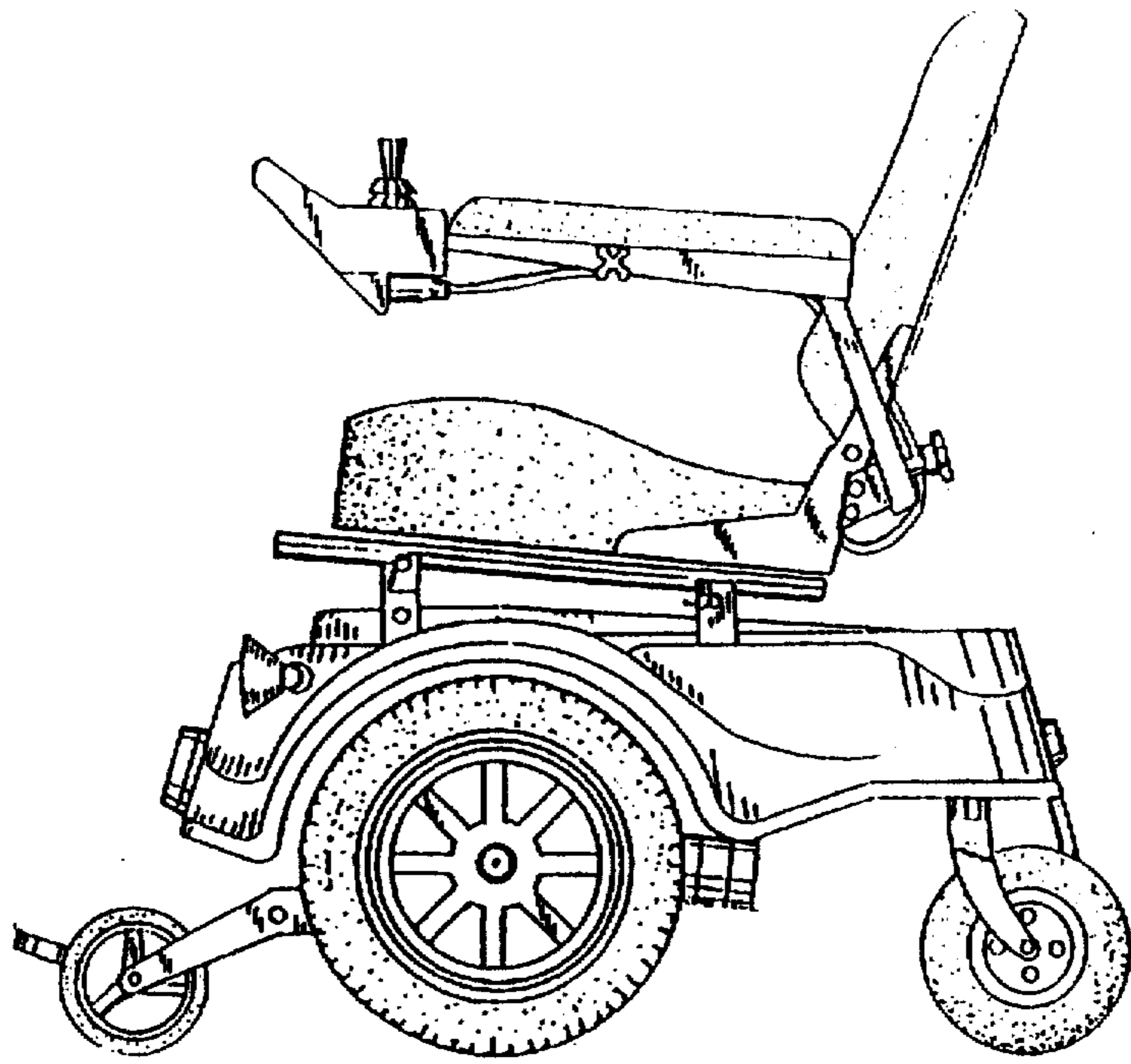

FIG. 4

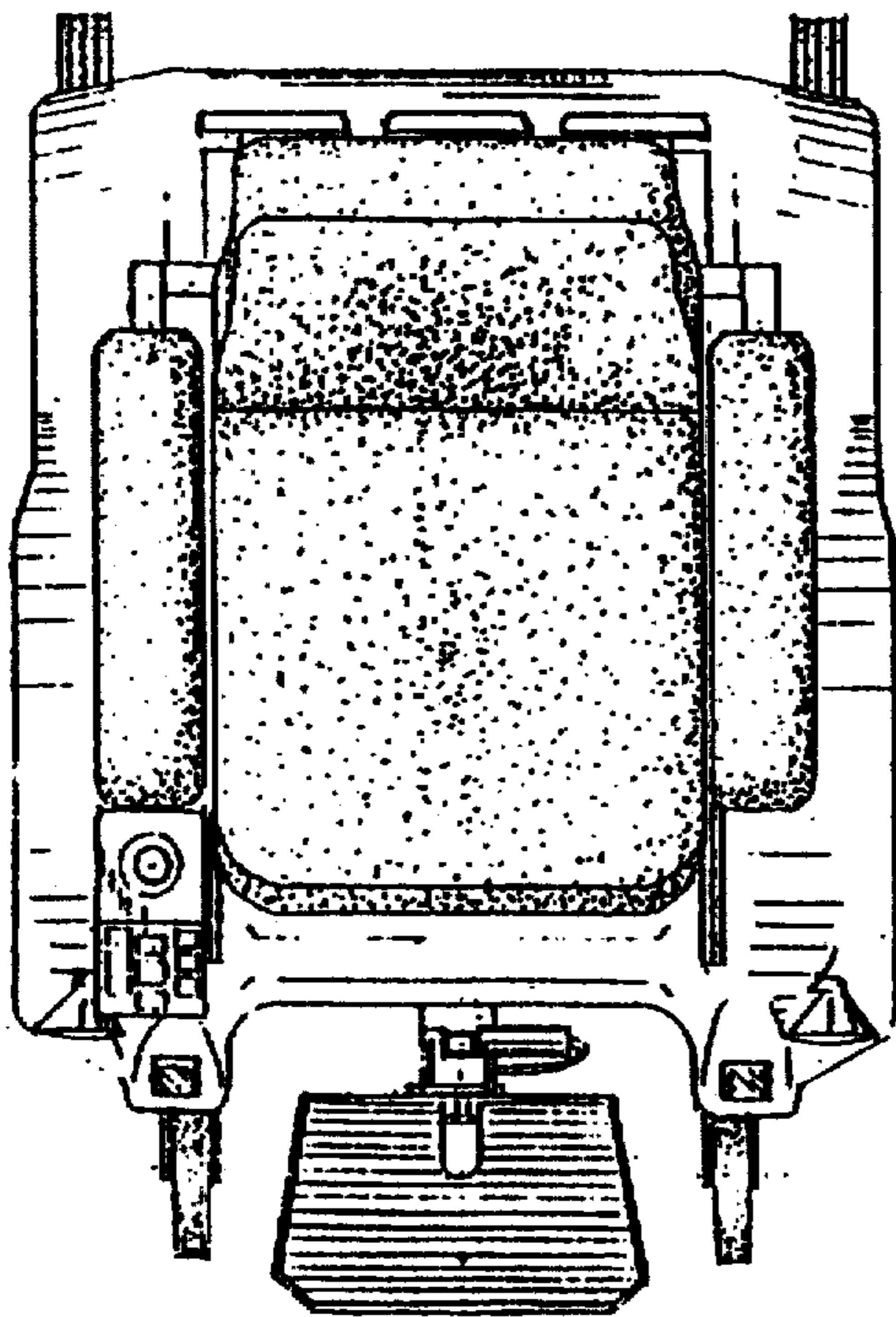

FIG. 5

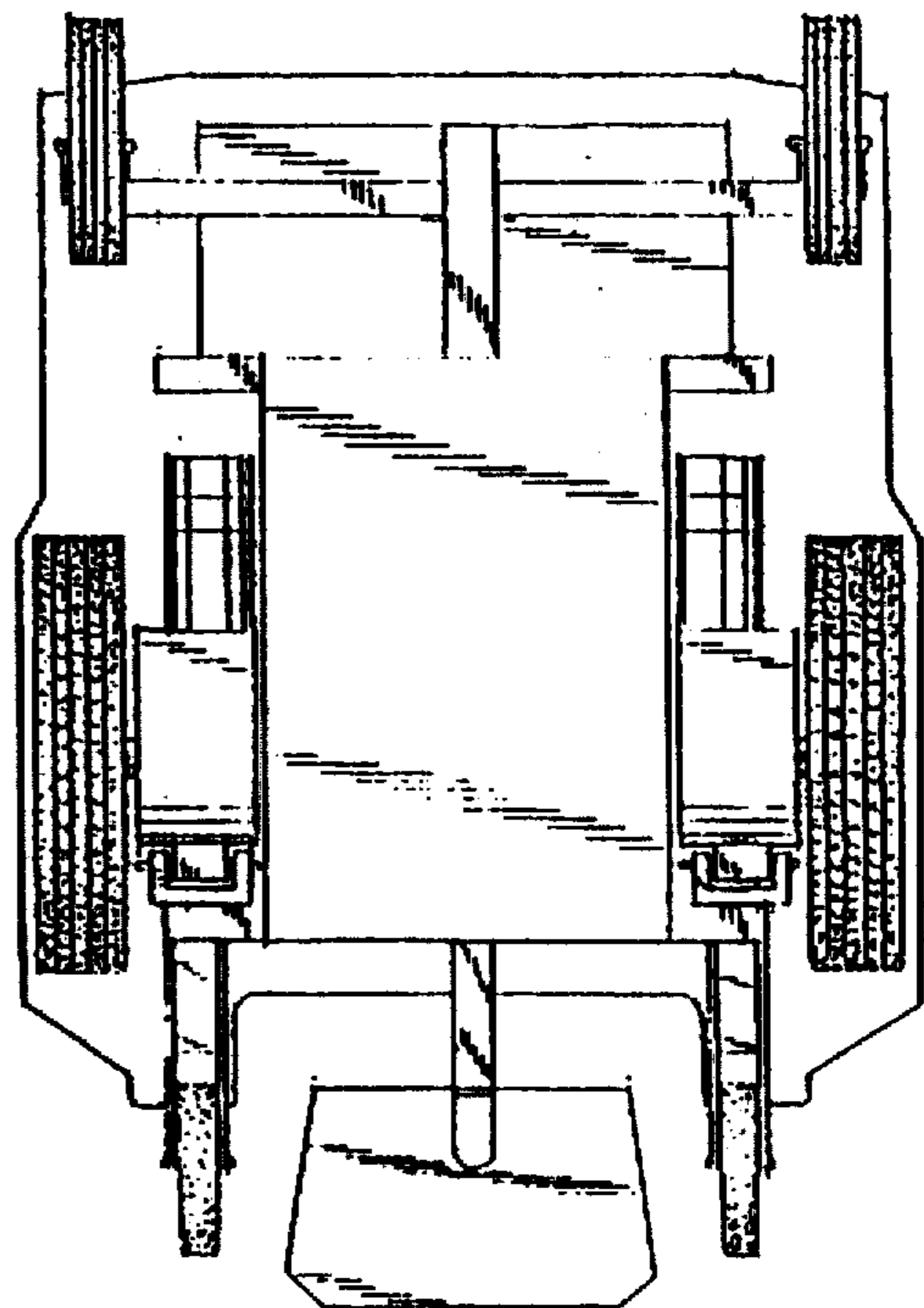

FIG. 6

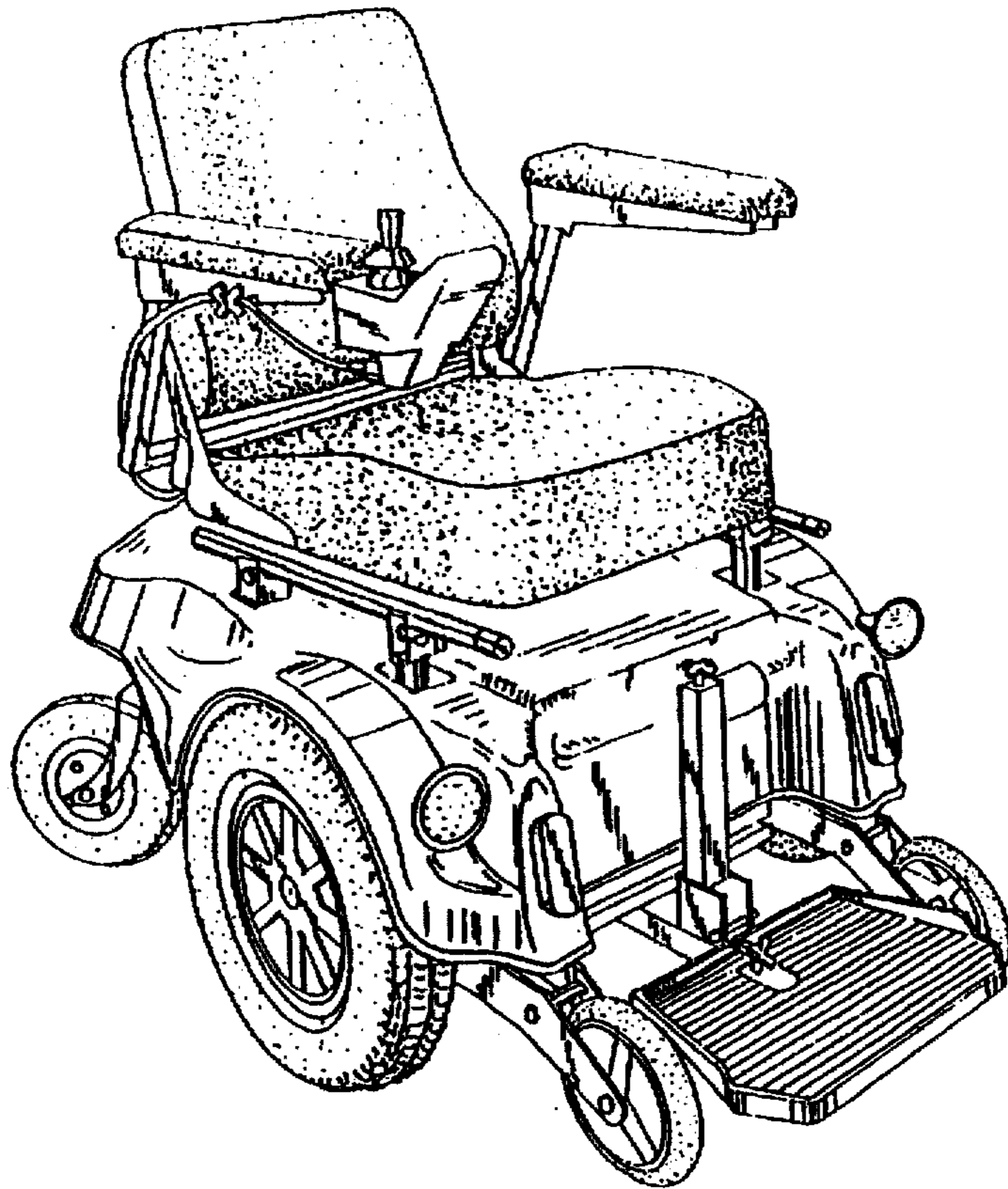

FIG. 7

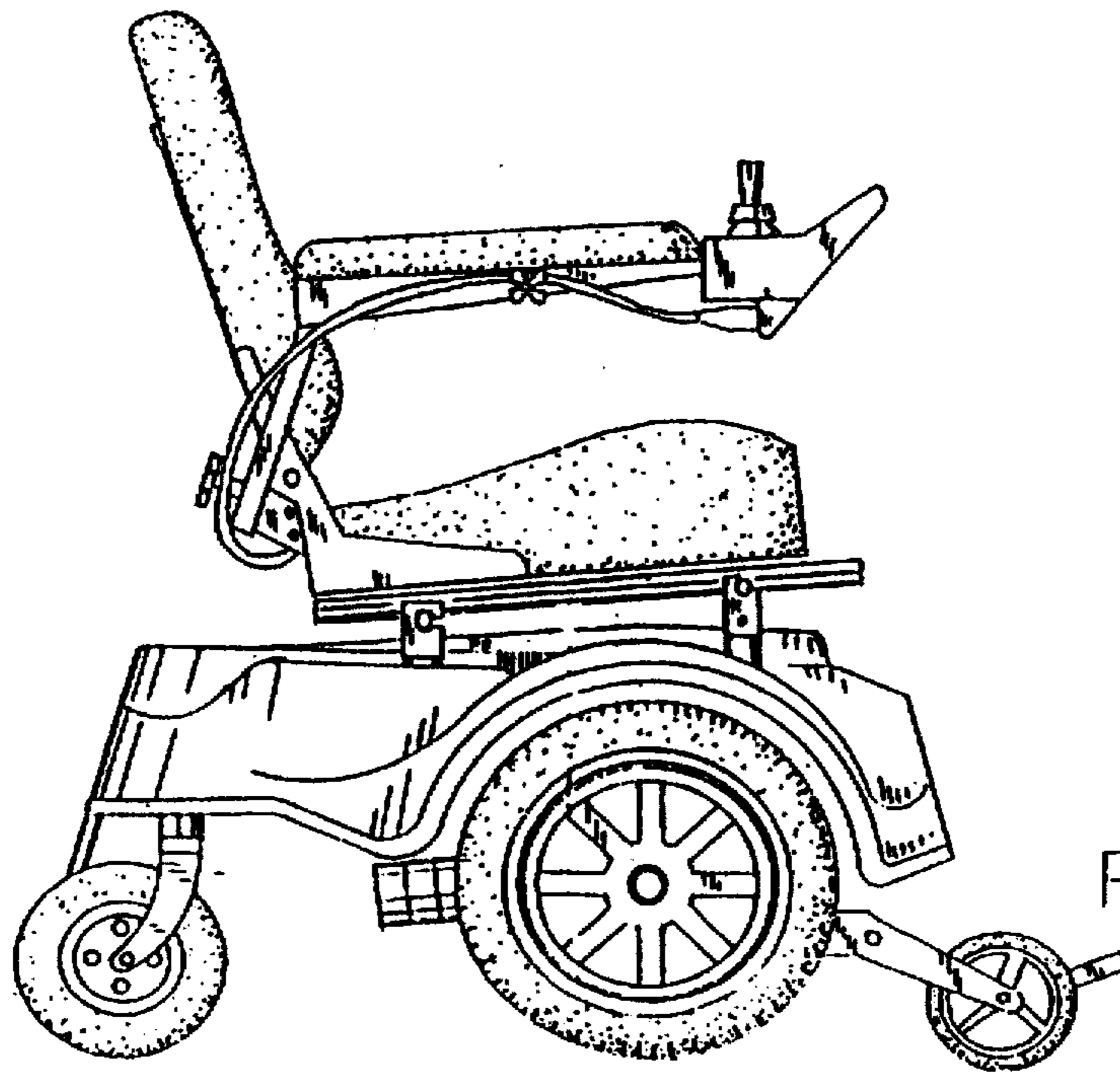

FIG. 8

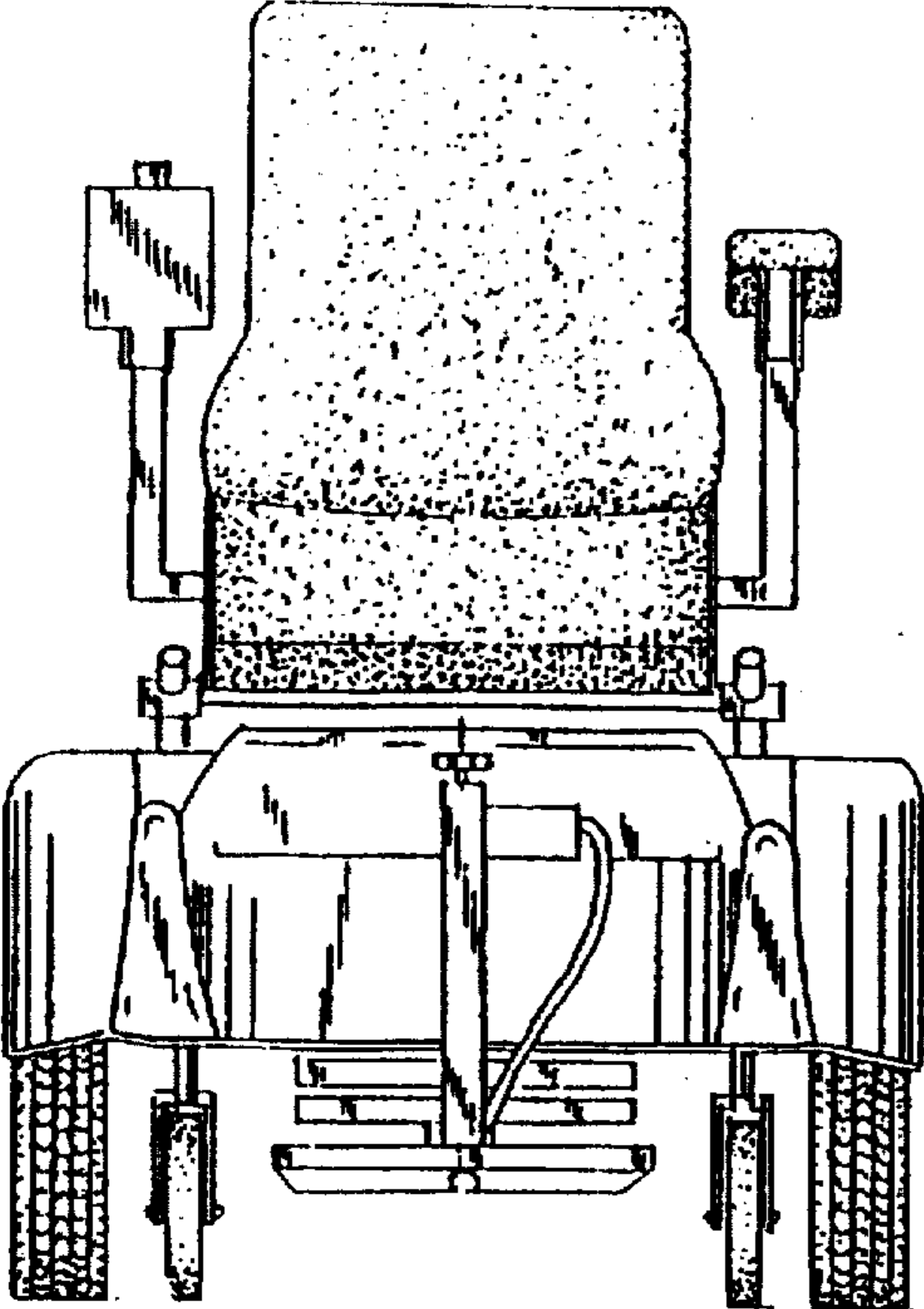

FIG. 9

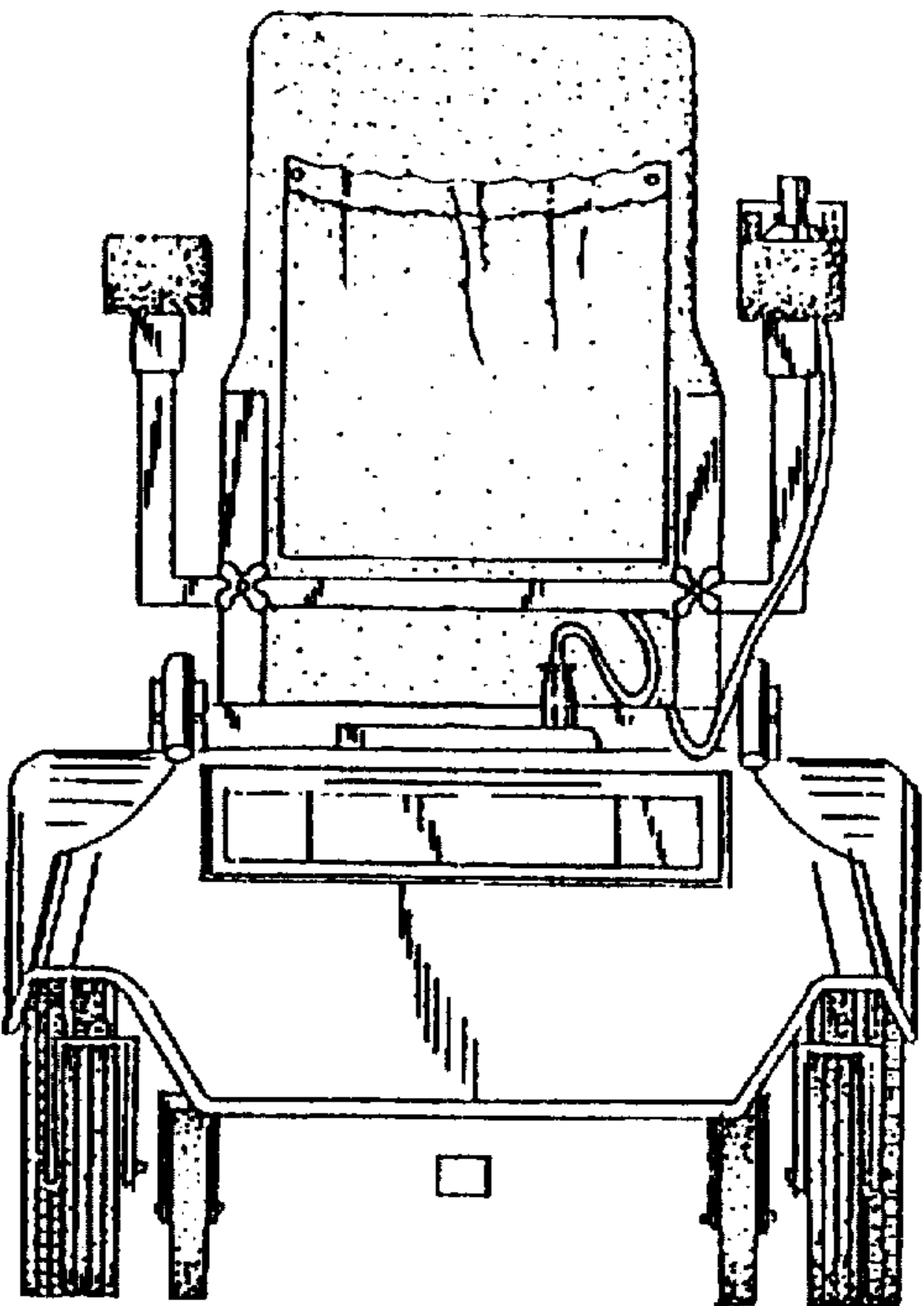

FIG. 10

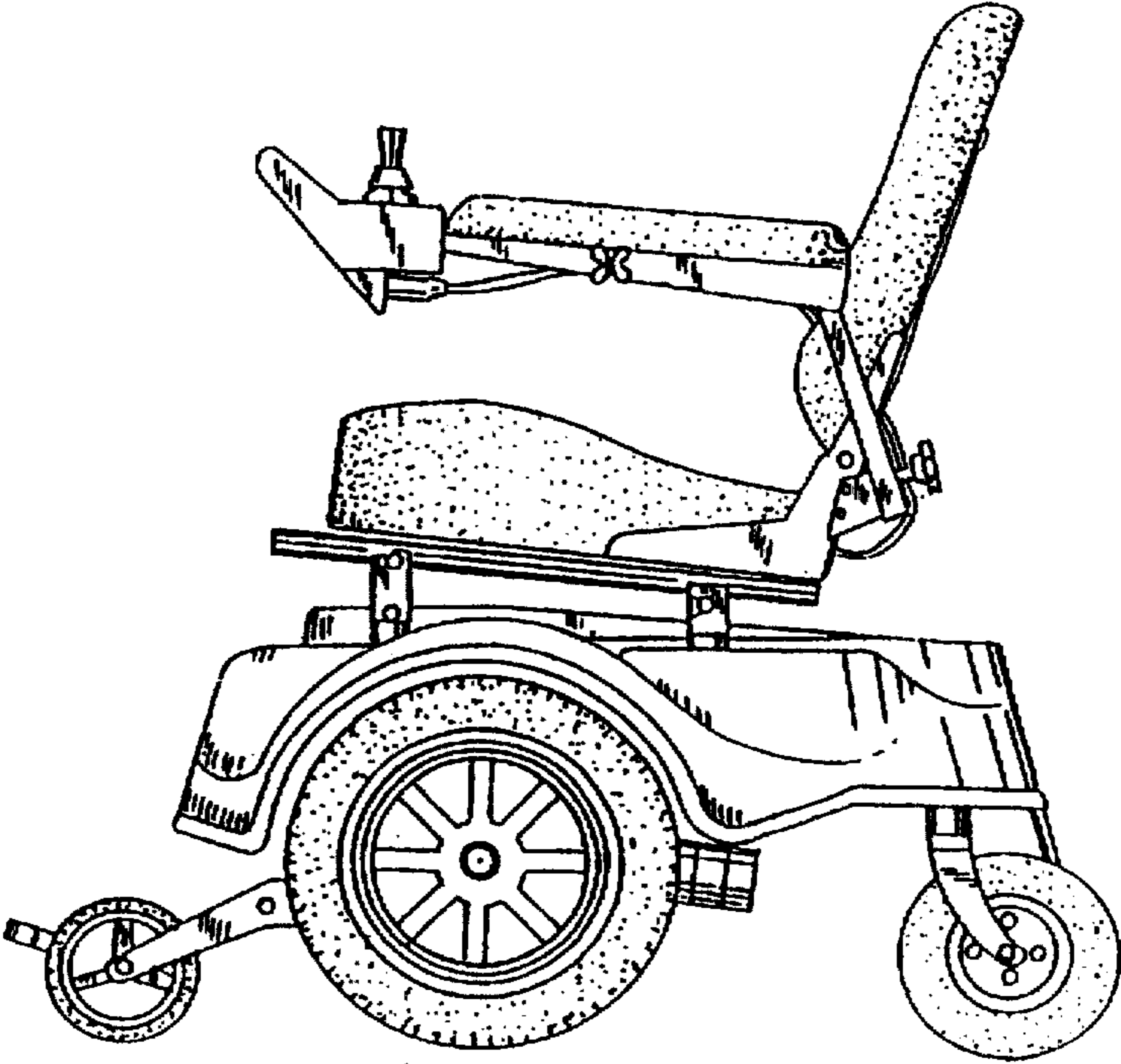

FIG. 11

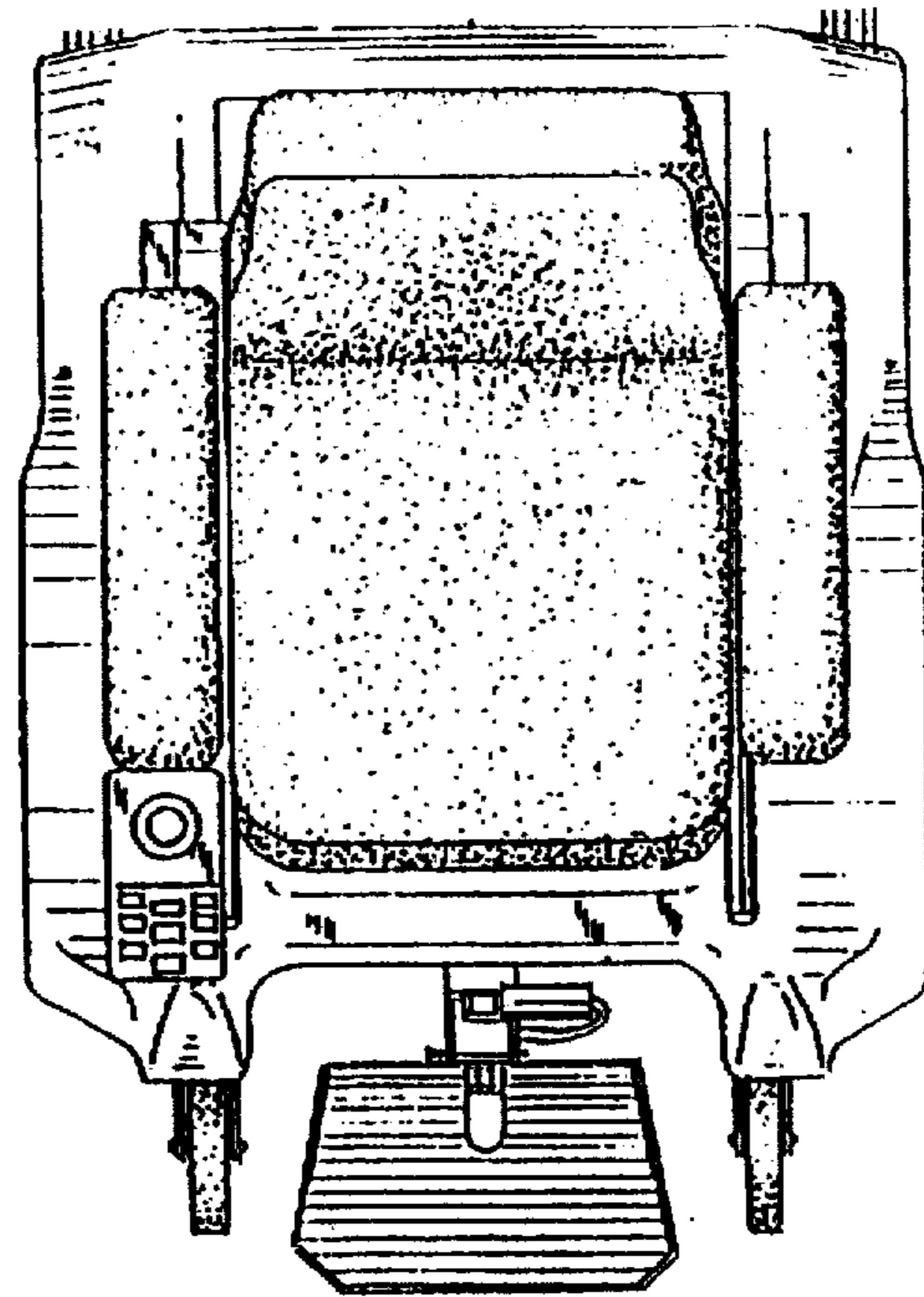

FIG. 12

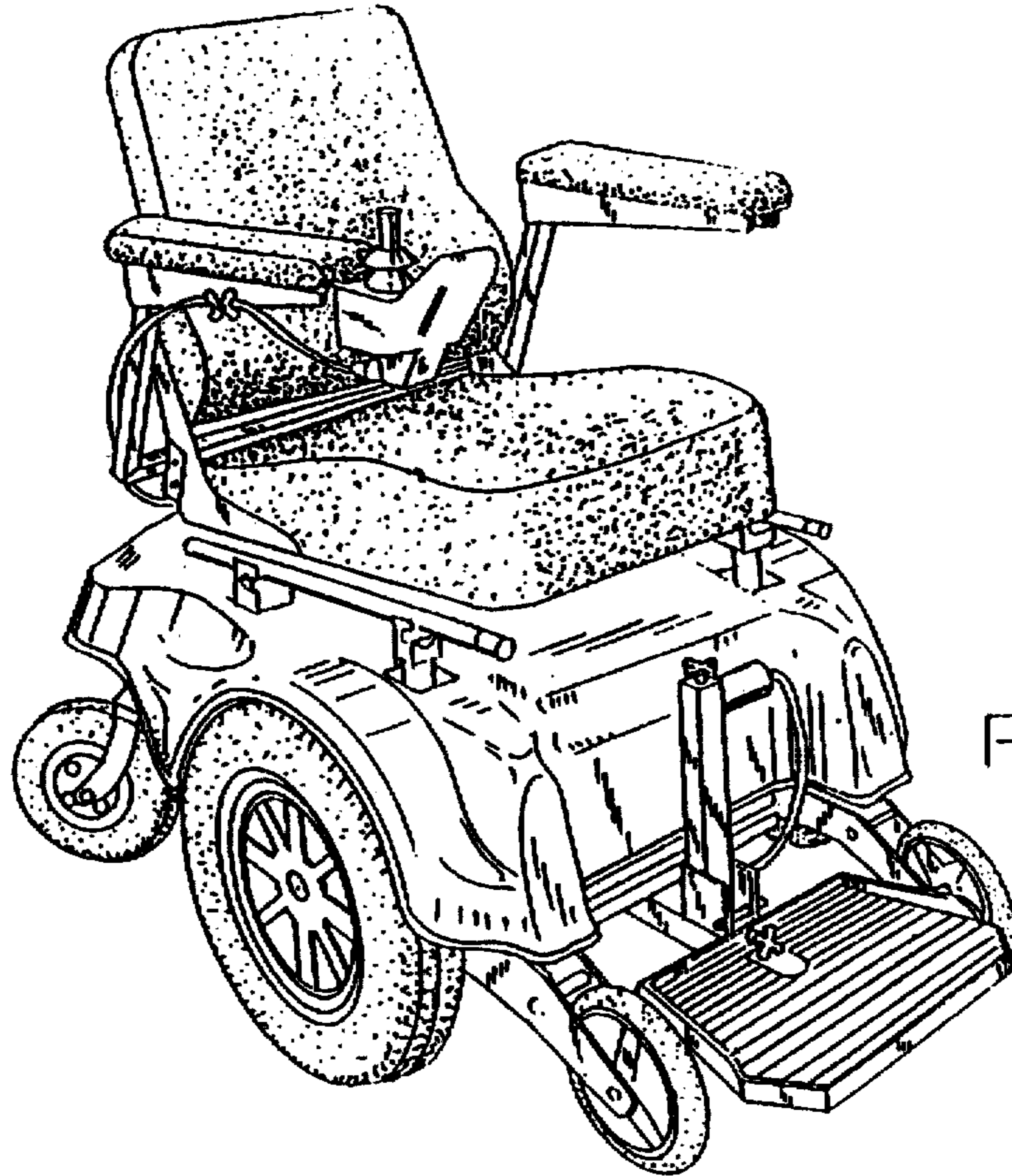

FIG. 13