



US00D397537S

United States Patent [19]
Ohmura

[11] **Patent Number:** **Des. 397,537**
[45] **Date of Patent:** ****Sep. 1, 1998**

[54] **LINE GUIDE FOR FISHING ROD**
[75] **Inventor:** **Ryuichi Ohmura, Shizuoka, Japan**
[73] **Assignee:** **Fuji Kogyo Co., Ltd., Shizuoka-ken, Japan**
[**] **Term:** **14 Years**
[21] **Appl. No.:** **73,889**
[22] **Filed:** **Jul. 18, 1997**
[30] **Foreign Application Priority Data**
Jan. 24, 1997 [JP] Japan 9-1720
[51] **LOC (6) Cl.** **22-05**
[52] **U.S. Cl.** **D2/143**
[58] **Field of Search** **D22/143; 43/24**

16-50 3/1979 Japan .
26866 of 1908 United Kingdom 43/24
1 232 060 5/1971 United Kingdom .
1542260 3/1979 United Kingdom 43/24
2082032 3/1982 United Kingdom 43/24

OTHER PUBLICATIONS

Perfection Tip Company Camping Products Company, Catalog No. 791.
Fishing Rod Mountings, Mildrum Manufacturing Company.
Quality Fishing Rod Rings By H&H, Hopikins & Holloway, Ltd.

Primary Examiner—Doris V. Coles
Attorney, Agent, or Firm—Evenson, McKeown, Edwards & Lenahan, P.L.L.C.

[57] **CLAIM**

The ornamental design for line guide for fishing rod, as shown and described.

DESCRIPTION

FIG. 1 is a perspective view of line guide for fishing rod embodying my new design;
FIG. 2 is a top plan view thereof;
FIG. 3 is a front elevational view, the rear being a mirror image thereof;
FIG. 4 is a bottom plan view thereof;
FIG. 5 is a right side elevational view thereof;
FIG. 6 is a left side elevational view thereof; and,
FIG. 7 is another front elevational view. The broken line showing of part of a fishing rod is for illustrative purposes only and form no part of claimed design.

[56] **References Cited**
U.S. PATENT DOCUMENTS
D. 108,720 3/1938 Morgan D22/143
D. 139,411 11/1944 Treadway D22/143
D. 155,954 11/1949 Wodetzky .
D. 200,780 4/1965 Golec .
D. 256,714 9/1980 Ohmura D22/143
D. 270,268 8/1983 Ohmura .
D. 280,656 9/1985 Ohmura D22/143
868,563 10/1907 Holzmann 43/24
1,149,131 8/1915 Hettinger 43/24
2,863,252 12/1958 Hettinger 43/24
3,034,248 5/1962 Williams 43/24
4,215,504 8/1980 Ohmura D22/143
4,697,375 10/1987 Mills 43/24

FOREIGN PATENT DOCUMENTS

1366213 6/1964 France 43/24

1 Claim, 2 Drawing Sheets

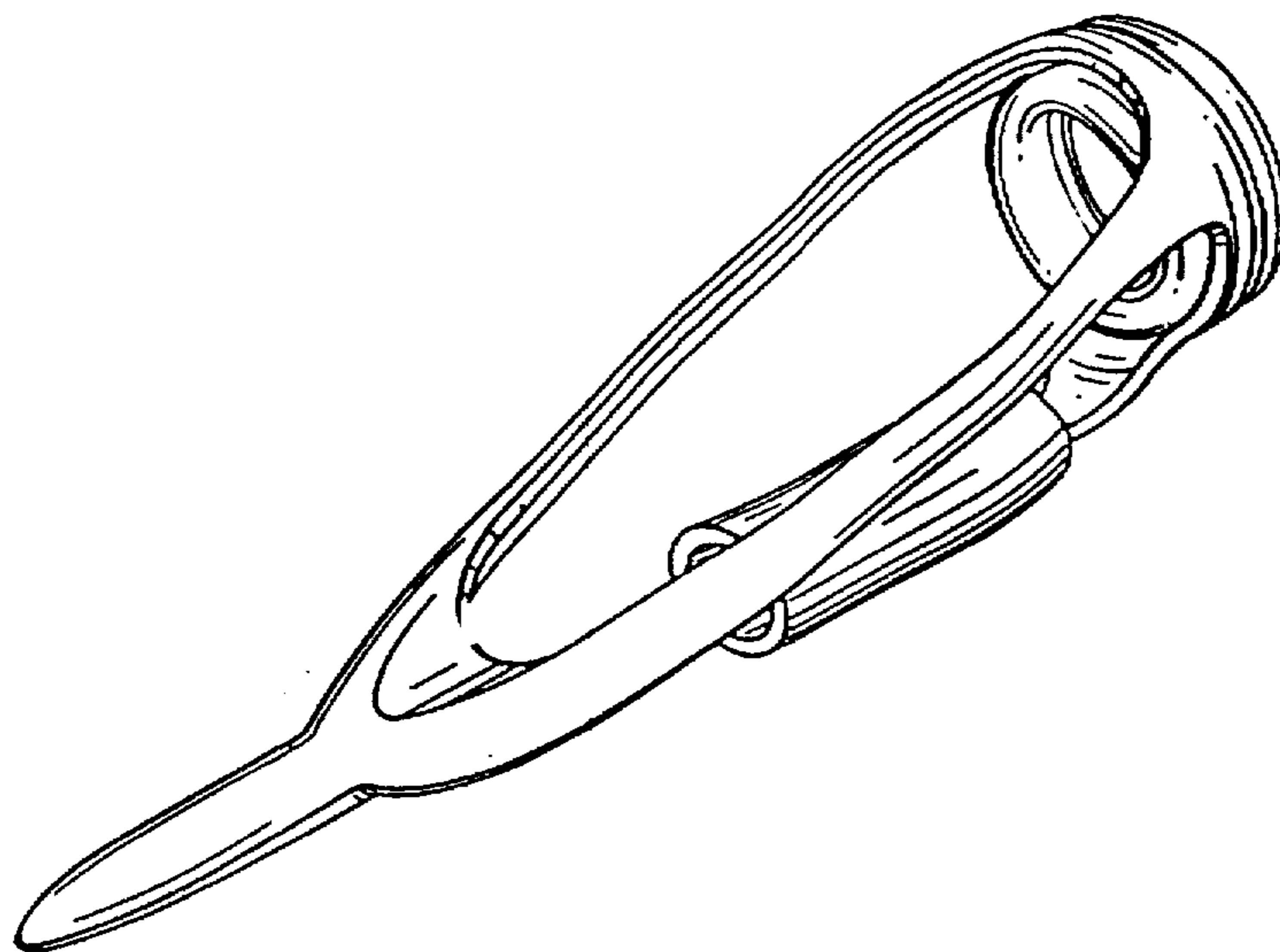

FIG. 1

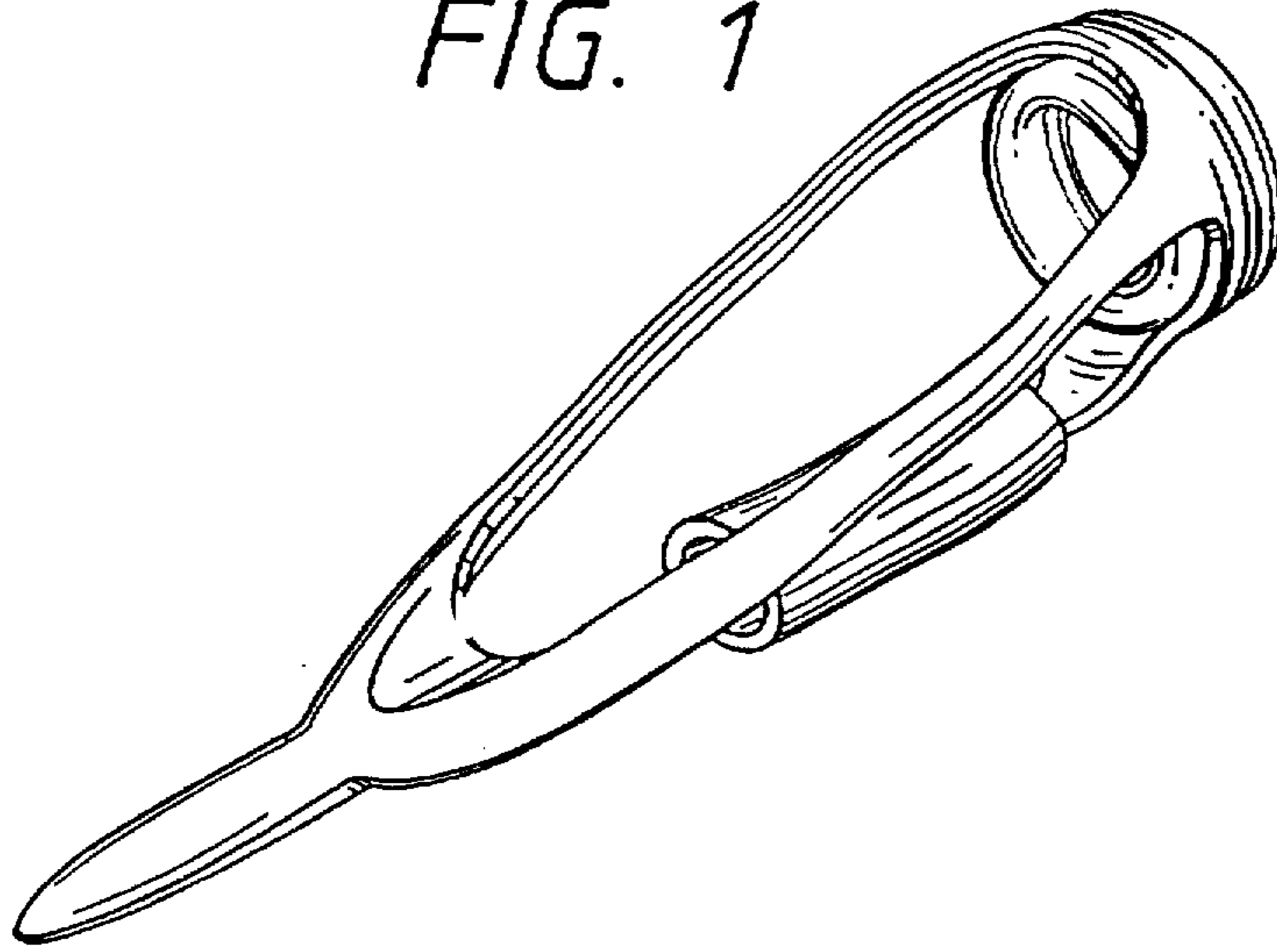

FIG. 2

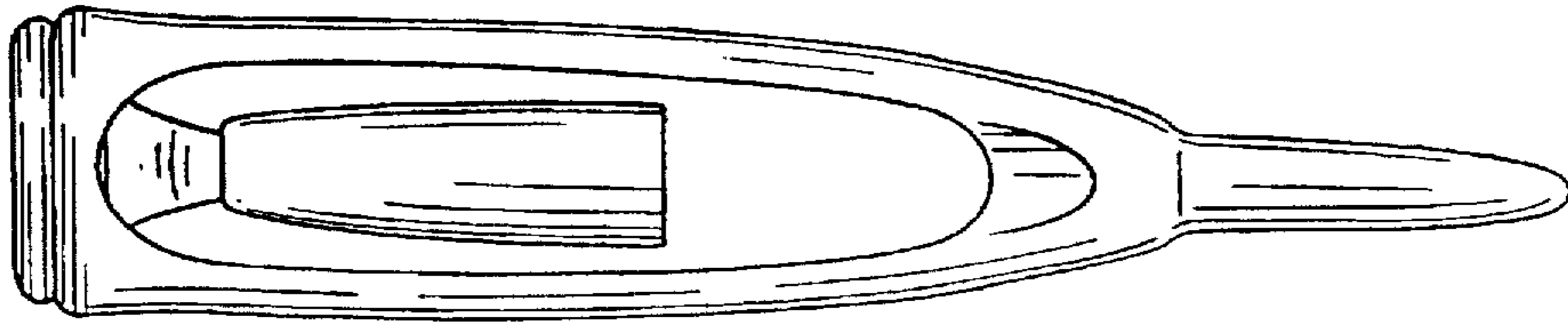

FIG. 3

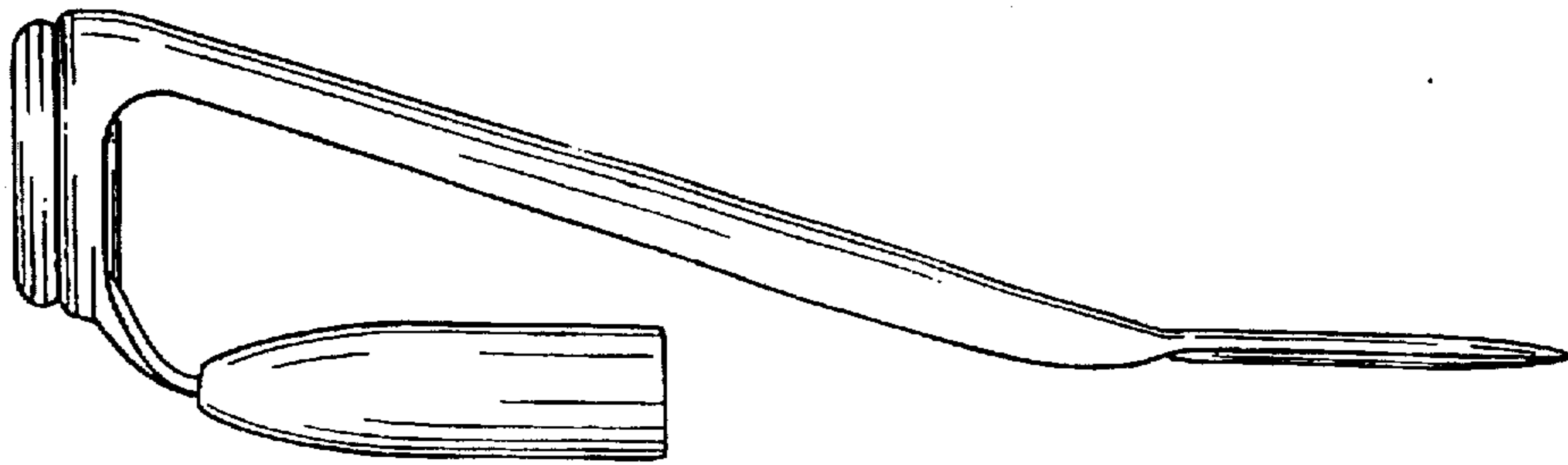

FIG. 4

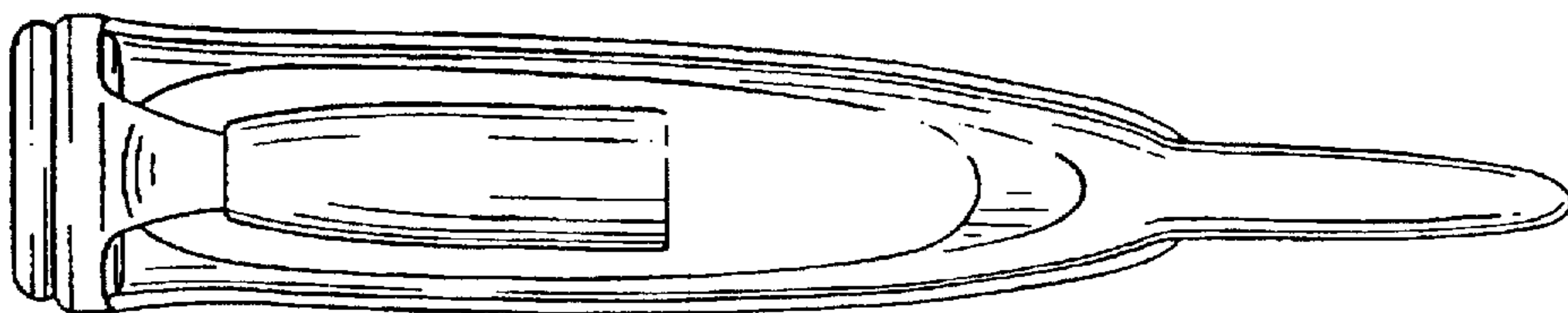

FIG. 5

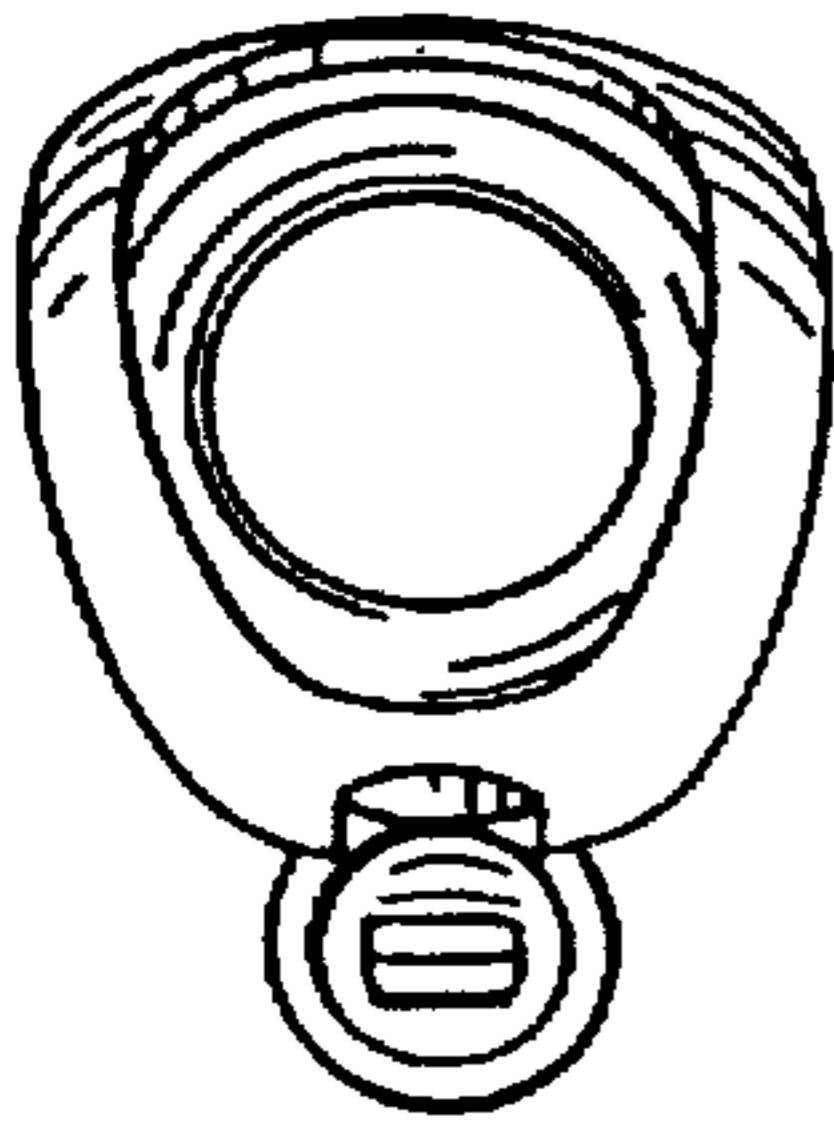

FIG. 6

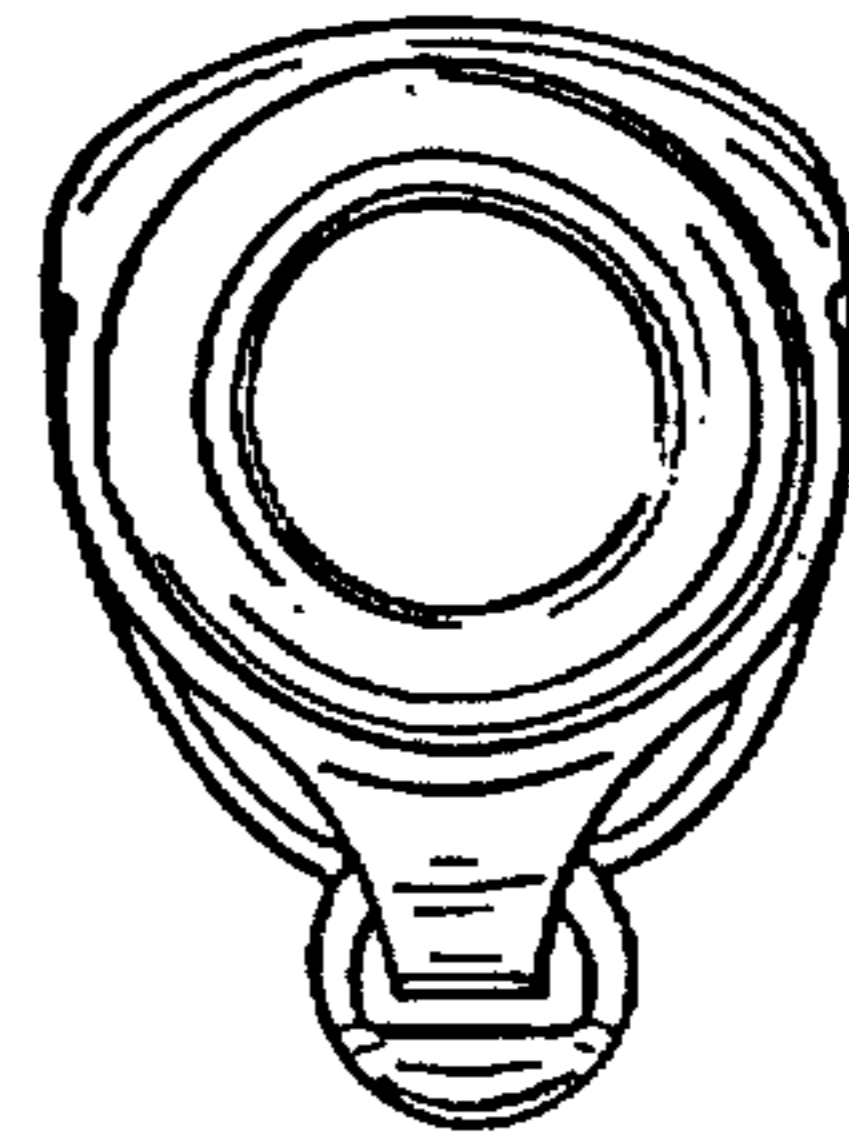

FIG. 7

