

US00D397357S

# United States Patent [19]

[11] Patent Number: **Des. 397,357**

**Herman et al.**

[45] Date of Patent: **\*\*Aug. 25, 1998**

[54] **PRINTER**

D. 374,031	9/1996	Ikenago .....	D18/50
D. 381,678	7/1997	Nakamura .....	D18/50
4,782,395	11/1988	Jeffers .....	D18/50

[75] Inventors: **Richard L. Herman; Frederick C. Miller; Carl W. Robinson**, all of Charlotte; **Robert P. Tennant**, Apex, all of N.C.

### FOREIGN PATENT DOCUMENTS

694076	8/1986	Japan .....	D18/55
855024	8/1992	Japan .....	D18/50

[73] Assignee: **International Business Machines Corporation**, Armonk, N.Y.

### OTHER PUBLICATIONS

[\*\*] Term: **14 Years**

Guide to FOSE Expo in Washington, DC; p. 32; Epson ActionPrinter 3250; Apr. 1993.

[21] Appl. No.: **65,300**

*Primary Examiner*—Cathy Anne MacCormac  
*Attorney, Agent, or Firm*—A. P. Tennent

[22] Filed: **Aug. 6, 1996**

### [57] CLAIM

### Related U.S. Application Data

The design for a printer, as shown and described.

[63] Continuation of Ser. No. 21,304, Apr. 11, 1994, abandoned.

### DESCRIPTION

[51] **LOC (6) Cl.** ..... **14-02**  
 [52] **U.S. Cl.** ..... **D18/55; D18/54**  
 [58] **Field of Search** ..... **D18/50, 54-55, D18/19; D14/107; 400/691-694, 690.1-690.4, 613, 613.1-613.4**

**FIG. 1** is a front, top and right side perspective of the design;  
**FIG. 2** is a front elevational view thereof;  
**FIG. 3** is a rear elevational view thereof;  
**FIG. 4** is a top plan view thereof;  
**FIG. 5** is a right side elevational view thereof;  
**FIG. 6** is a left side elevational view thereof;  
**FIG. 7** is a bottom plan view thereof;  
**FIG. 8** is a front, top and right side perspective view of **FIG. 1** without the paper tray;  
**FIG. 9** is a front elevational view of **FIG. 8**;  
**FIG. 10** is a top plan view of **FIG. 8**;  
**FIG. 11** is a right side elevational view of **FIG. 8**;  
**FIG. 12** is a left side elevational view of **FIG. 8**;  
**FIG. 13** is a bottom plan view of **FIG. 8**; and,  
**FIG. 14** is a front elevational view of a second embodiment of **FIG. 1**.

### [56] References Cited

#### U.S. PATENT DOCUMENTS

D. 288,324	2/1987	Moggridge .....	D18/54
D. 295,853	5/1988	Ooie .....	D18/55
D. 318,483	7/1991	Tashiro .....	D18/55
D. 320,616	10/1991	Takahashi .....	D18/55
D. 323,845	2/1992	Kawaguchi .....	D18/55
D. 331,069	11/1992	Hanasaki et al. ....	D18/55
D. 334,022	3/1993	Byun .....	D18/50
D. 340,258	10/1993	Asakura et al. ....	D18/55
D. 340,946	11/1993	Kobayashi .....	D18/55
D. 369,826	5/1996	Ichiyoshi .....	D18/50

**1 Claim, 12 Drawing Sheets**

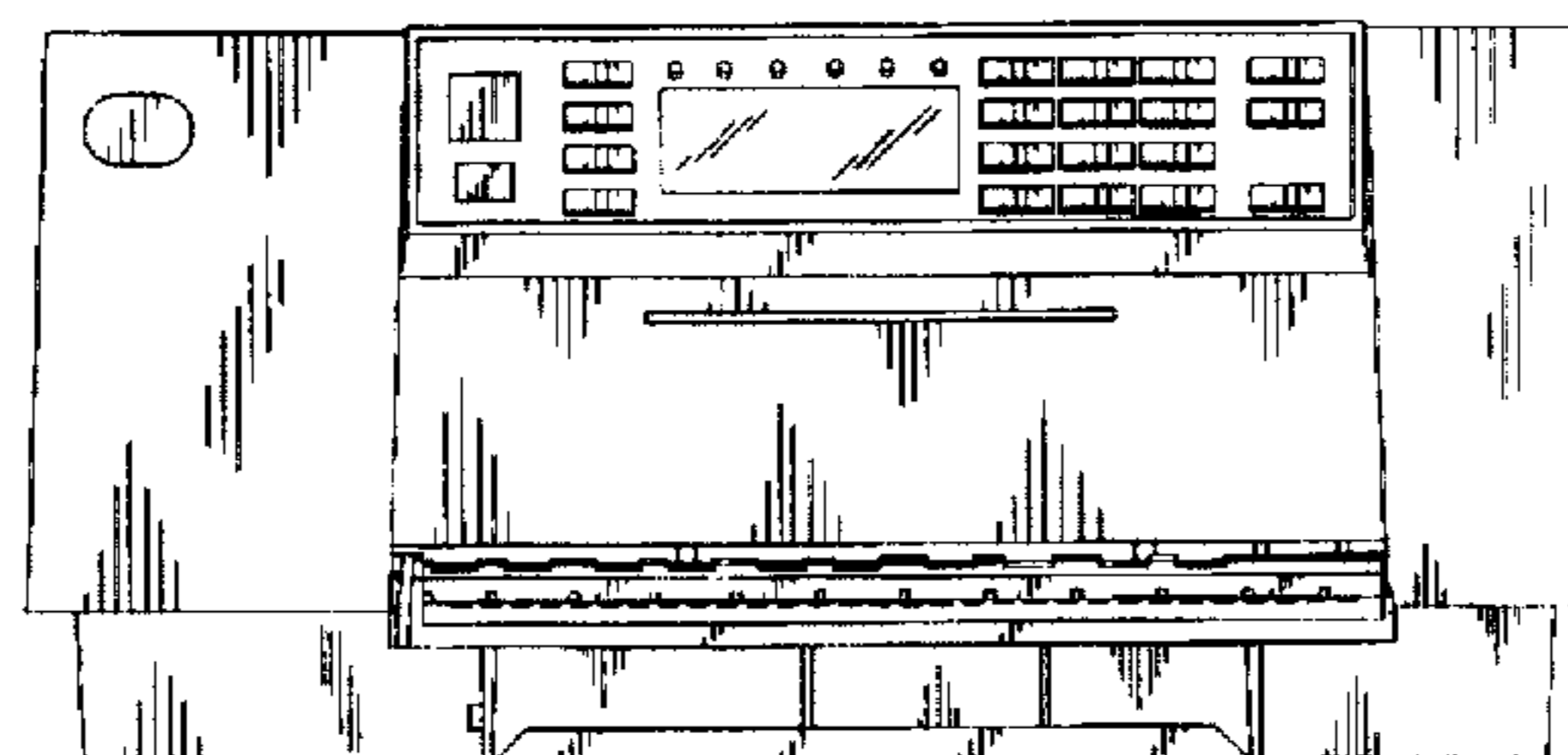
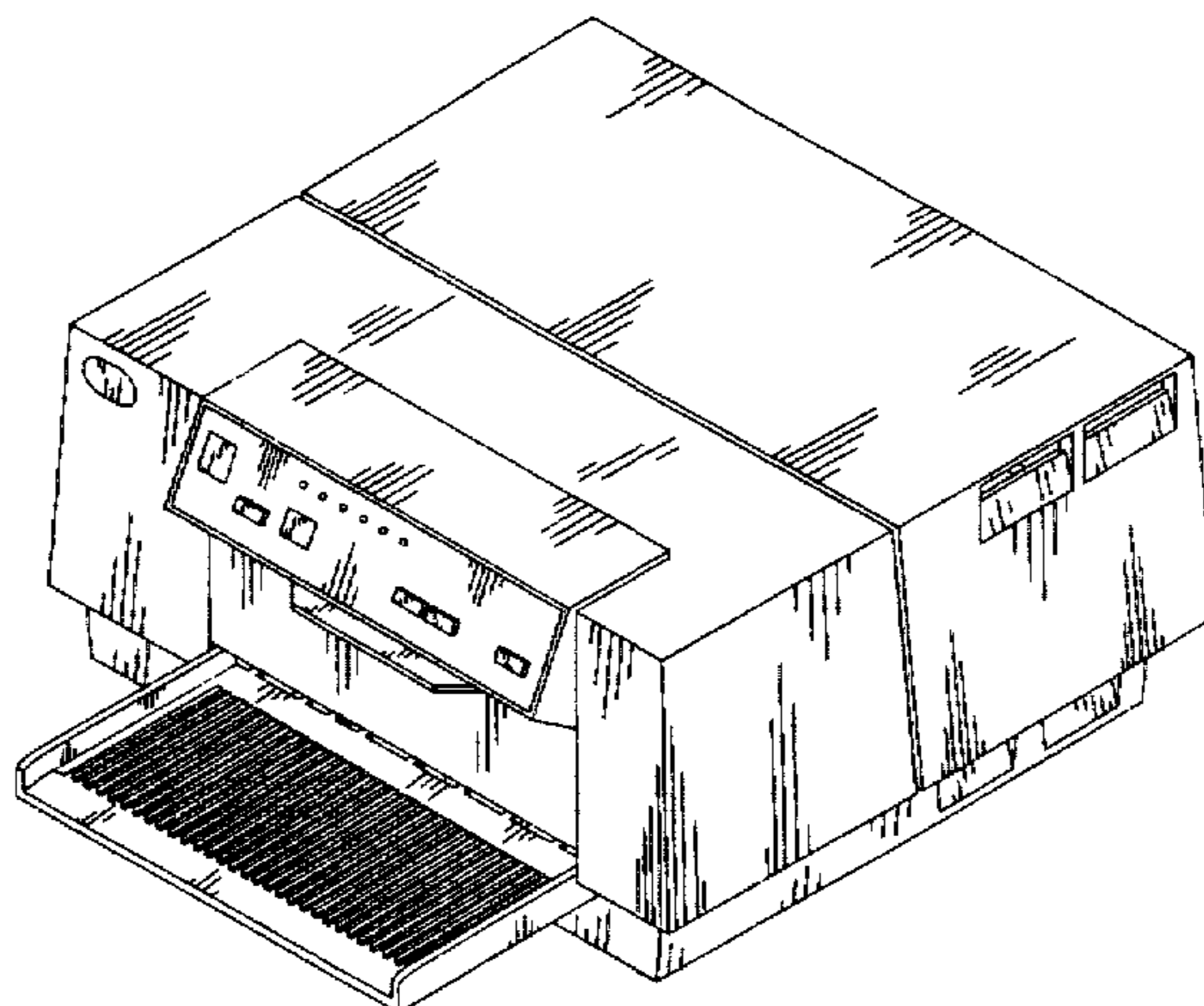

FIG. 1

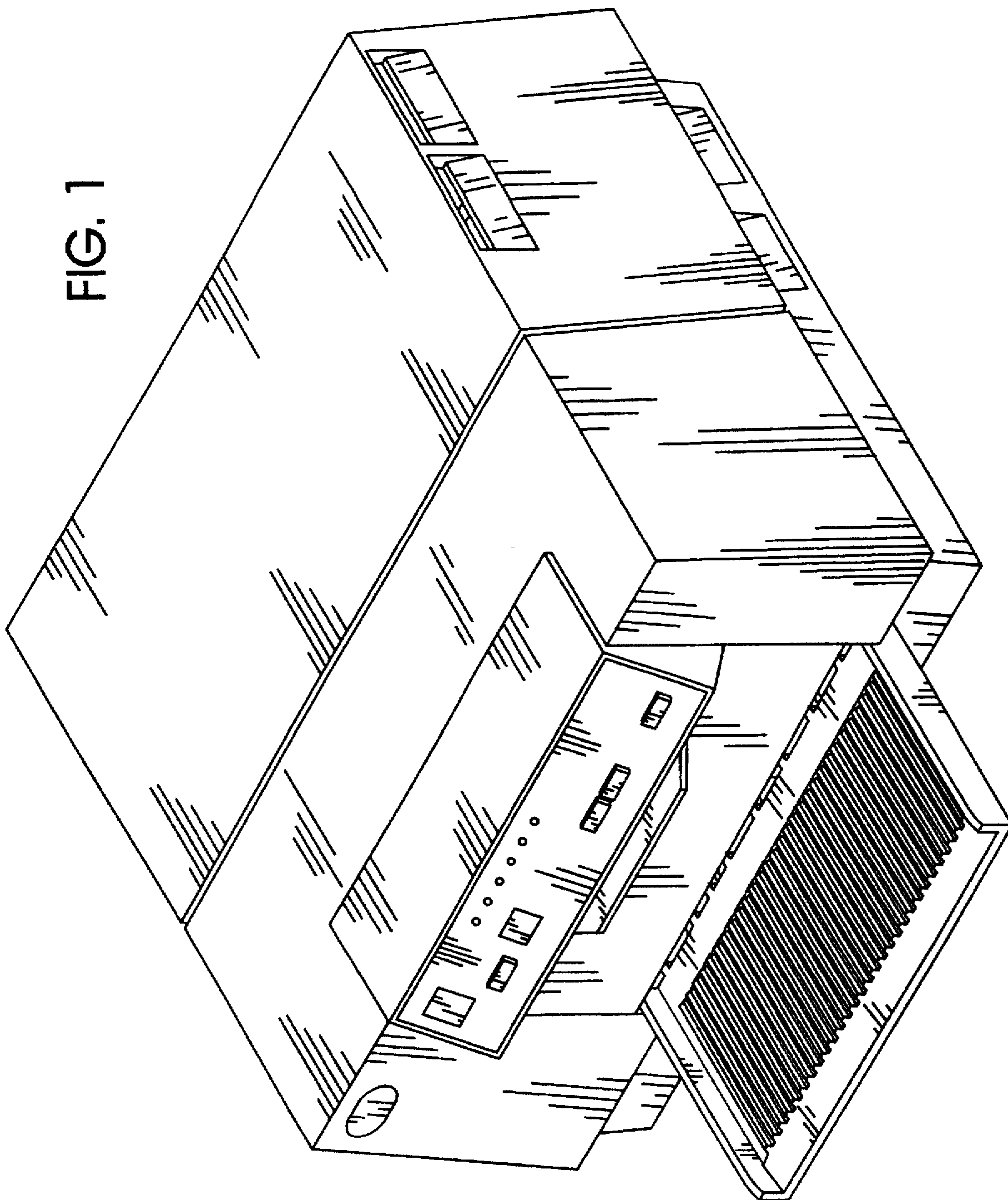

FIG. 2

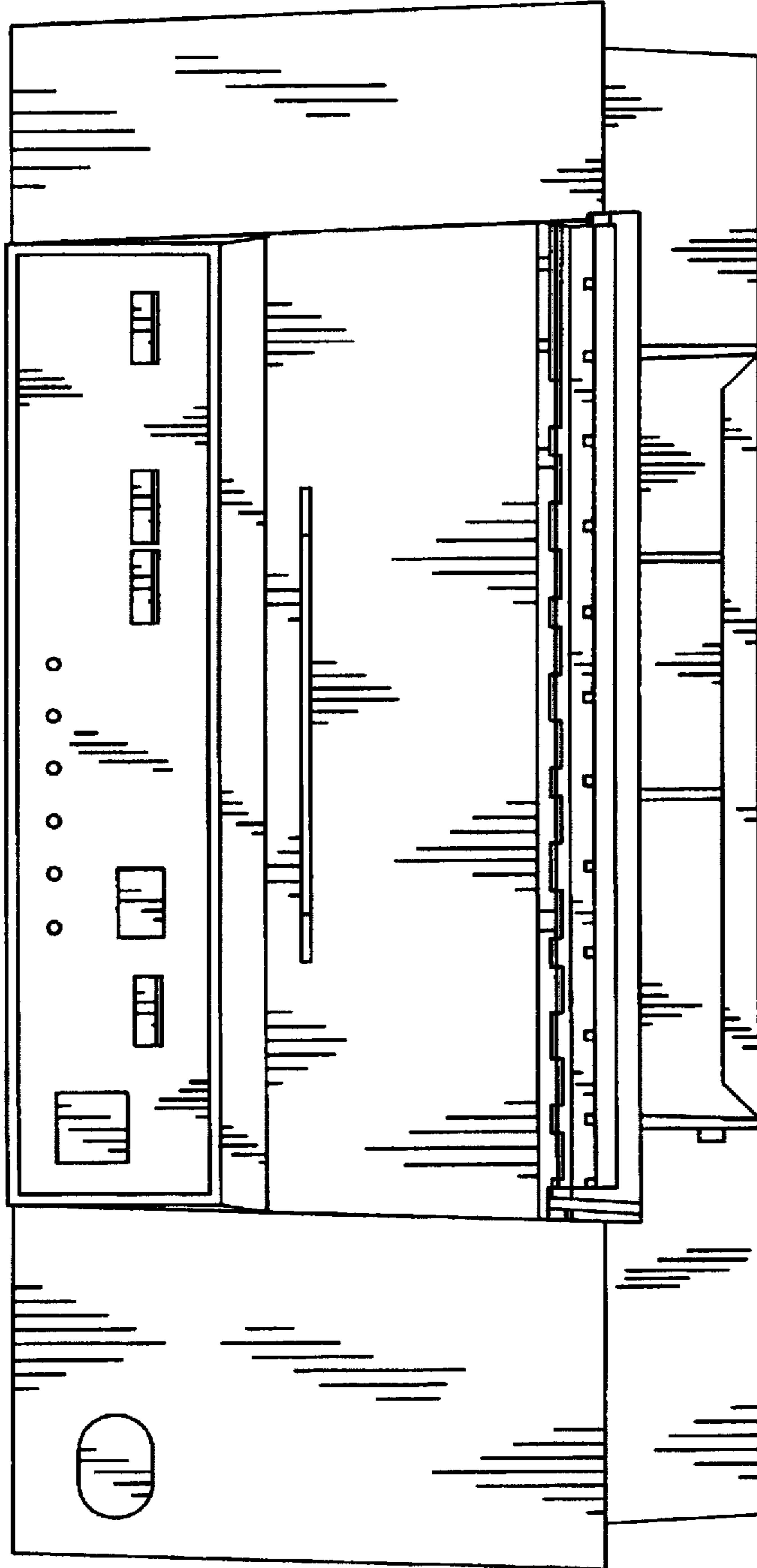

FIG. 3

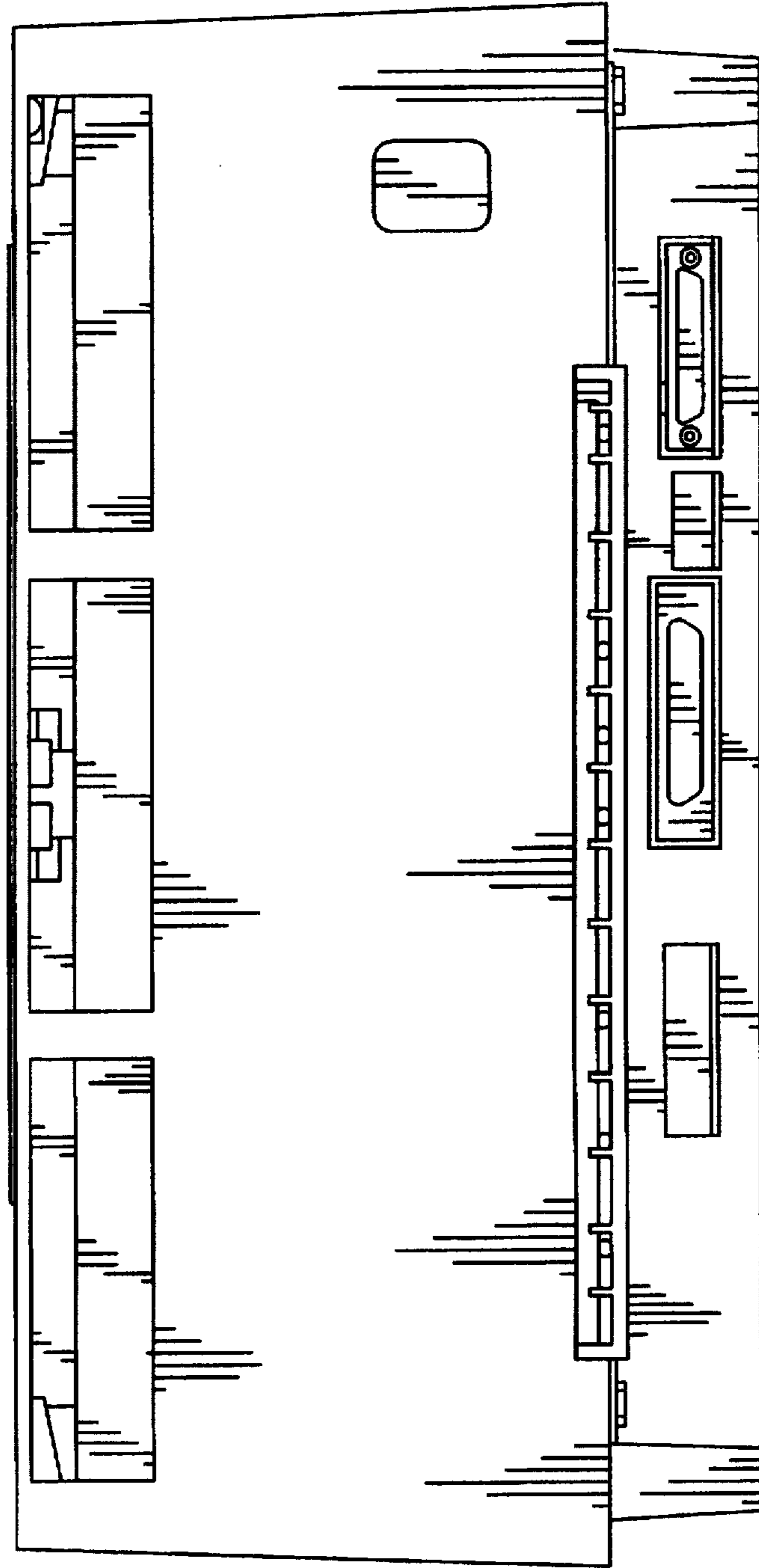

FIG. 4

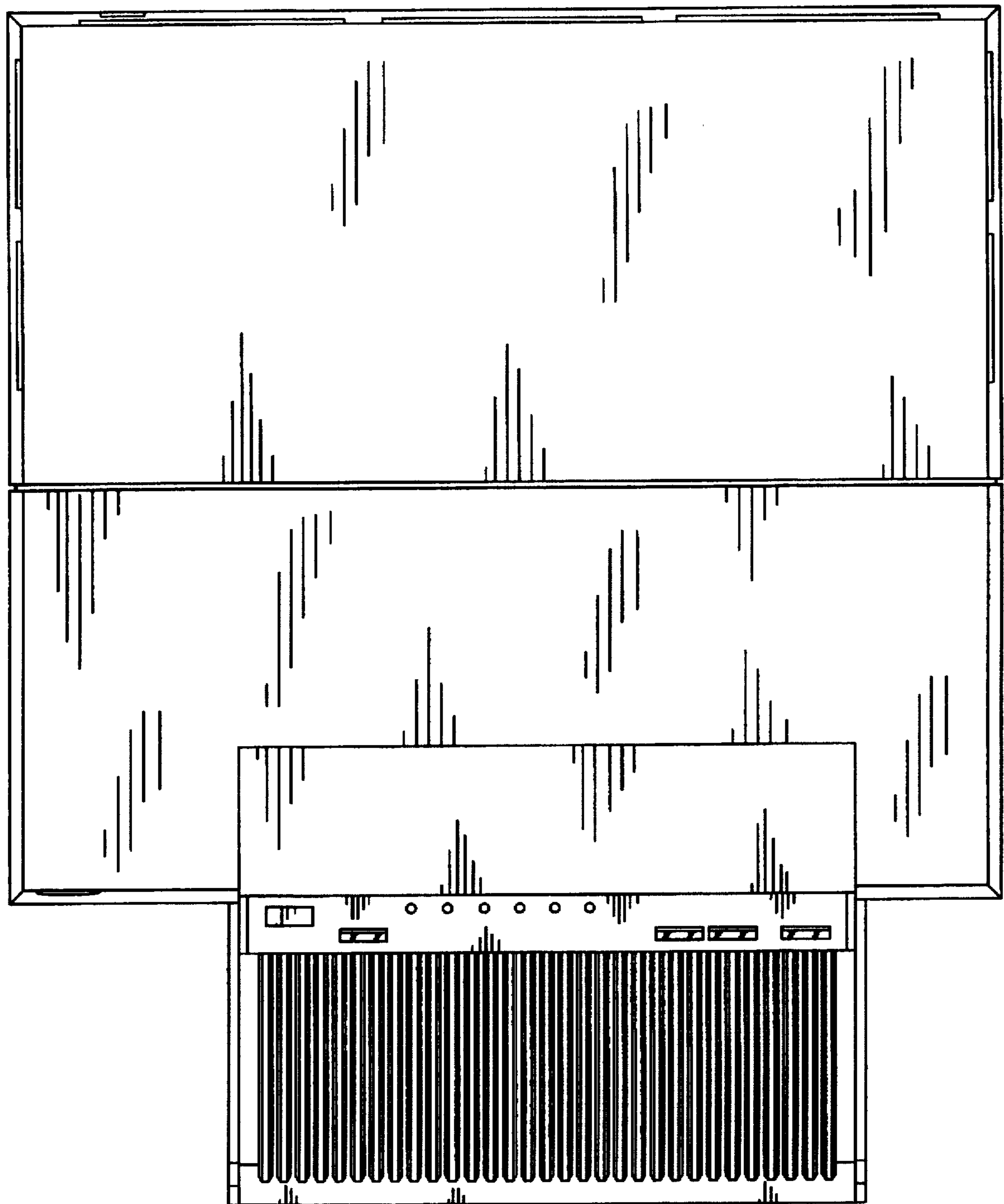

FIG. 5

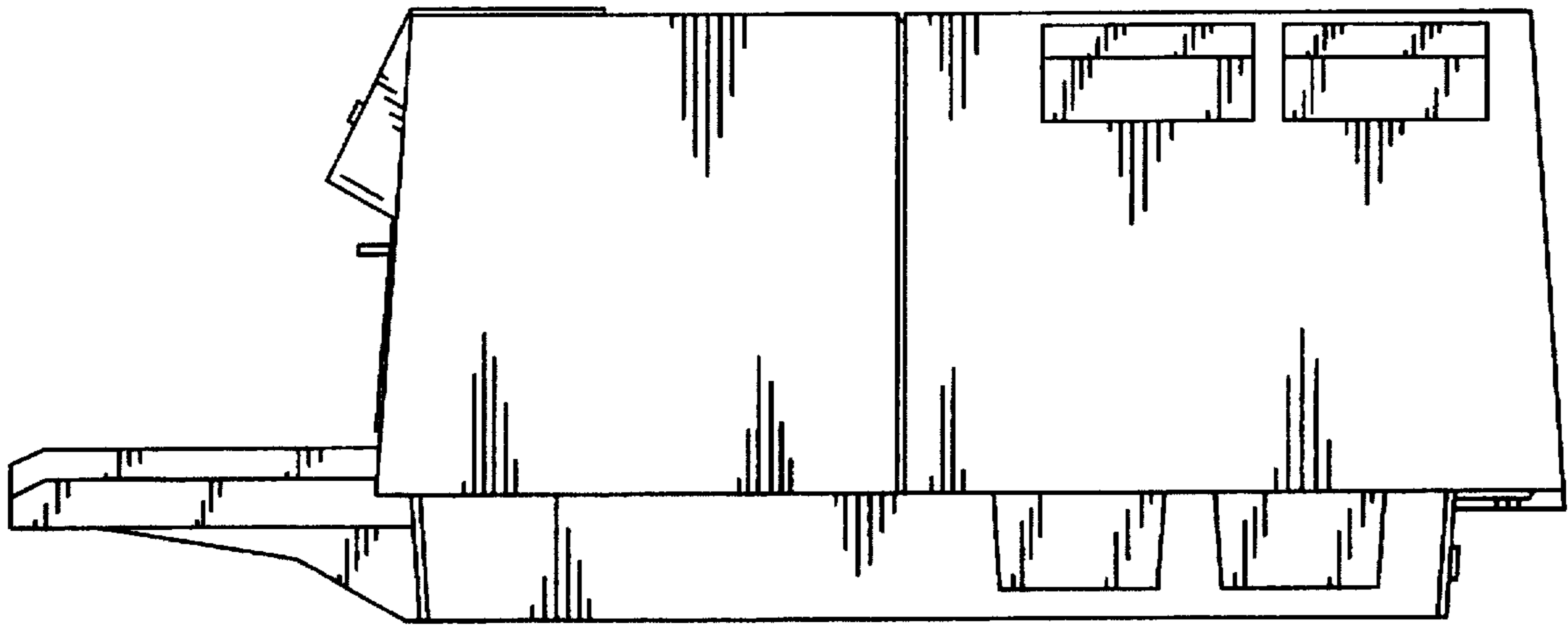

FIG. 6

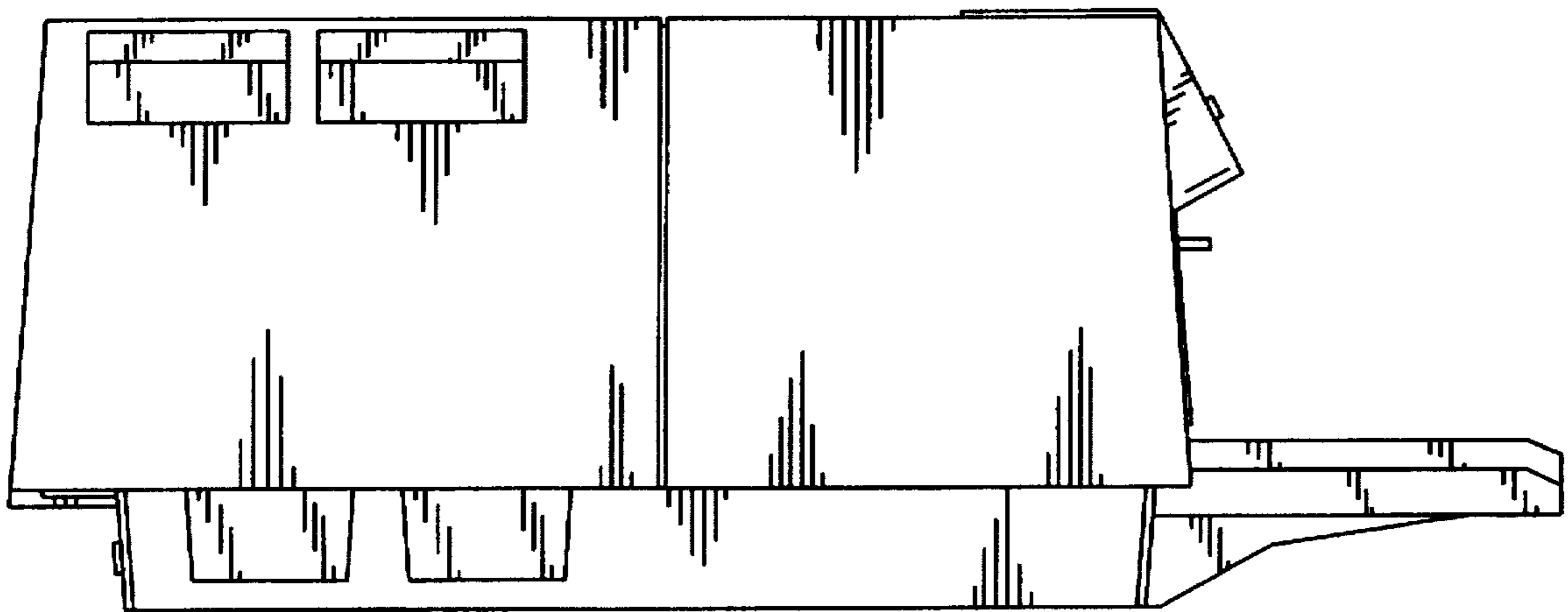

FIG. 7

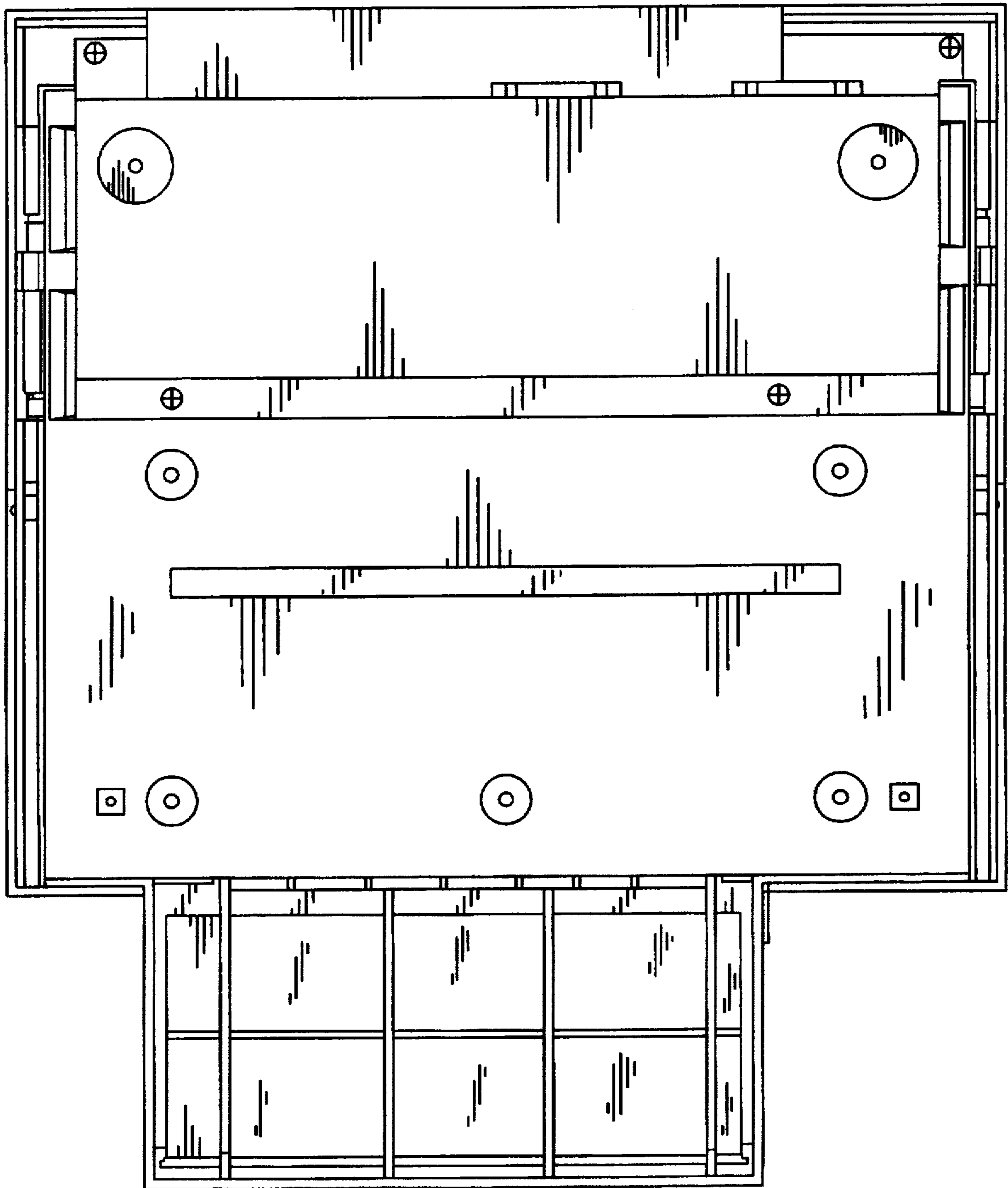

FIG. 8

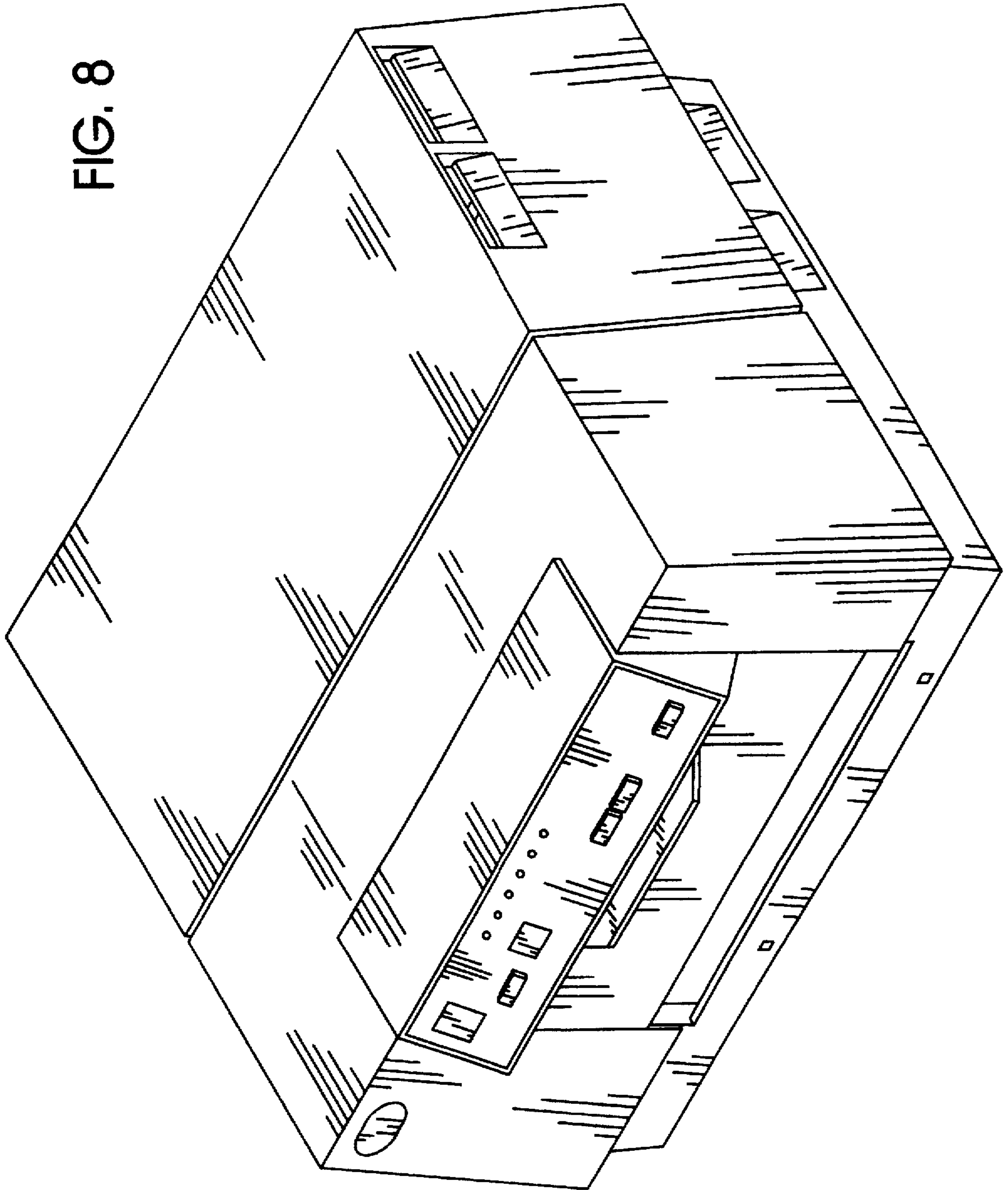



FIG. 9

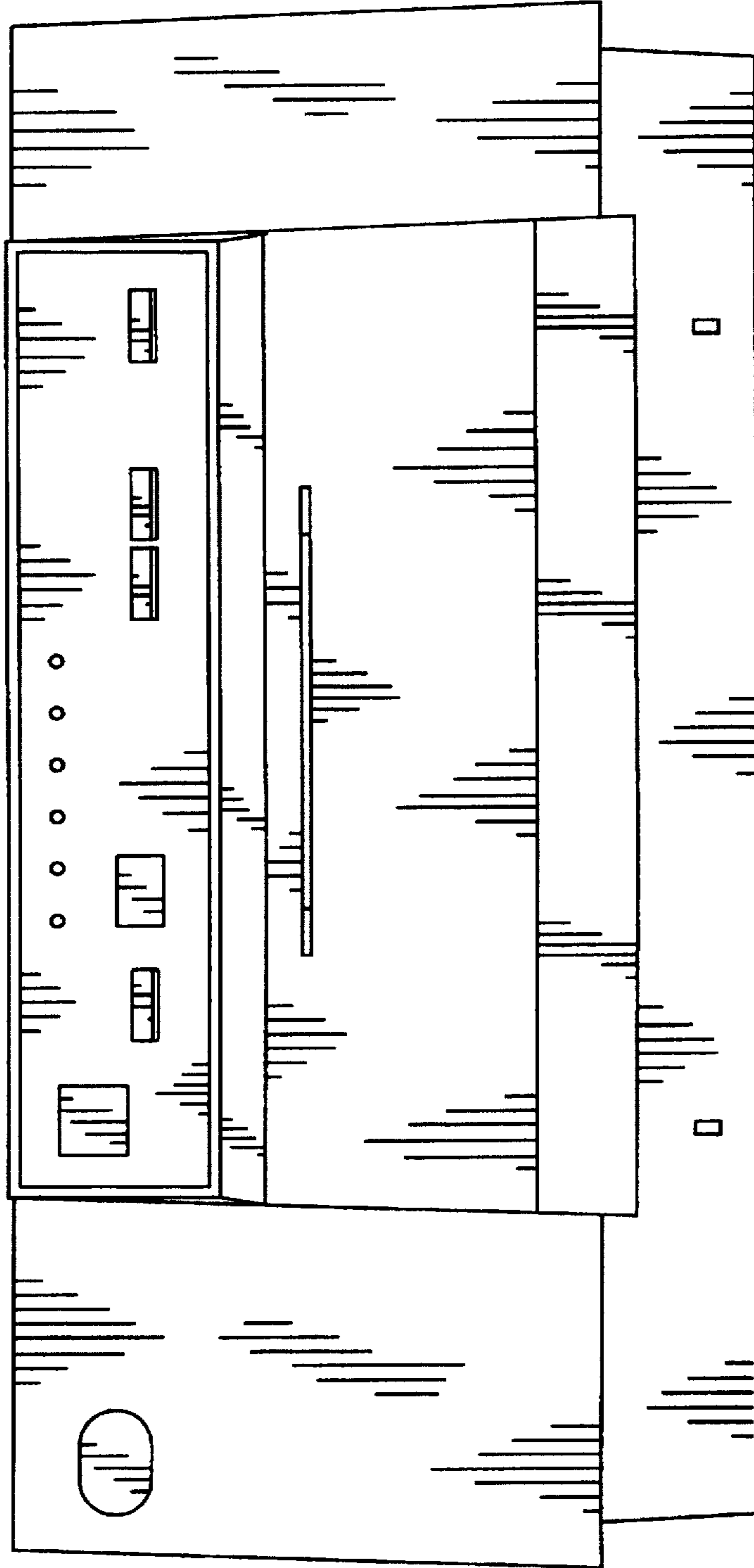

FIG. 10

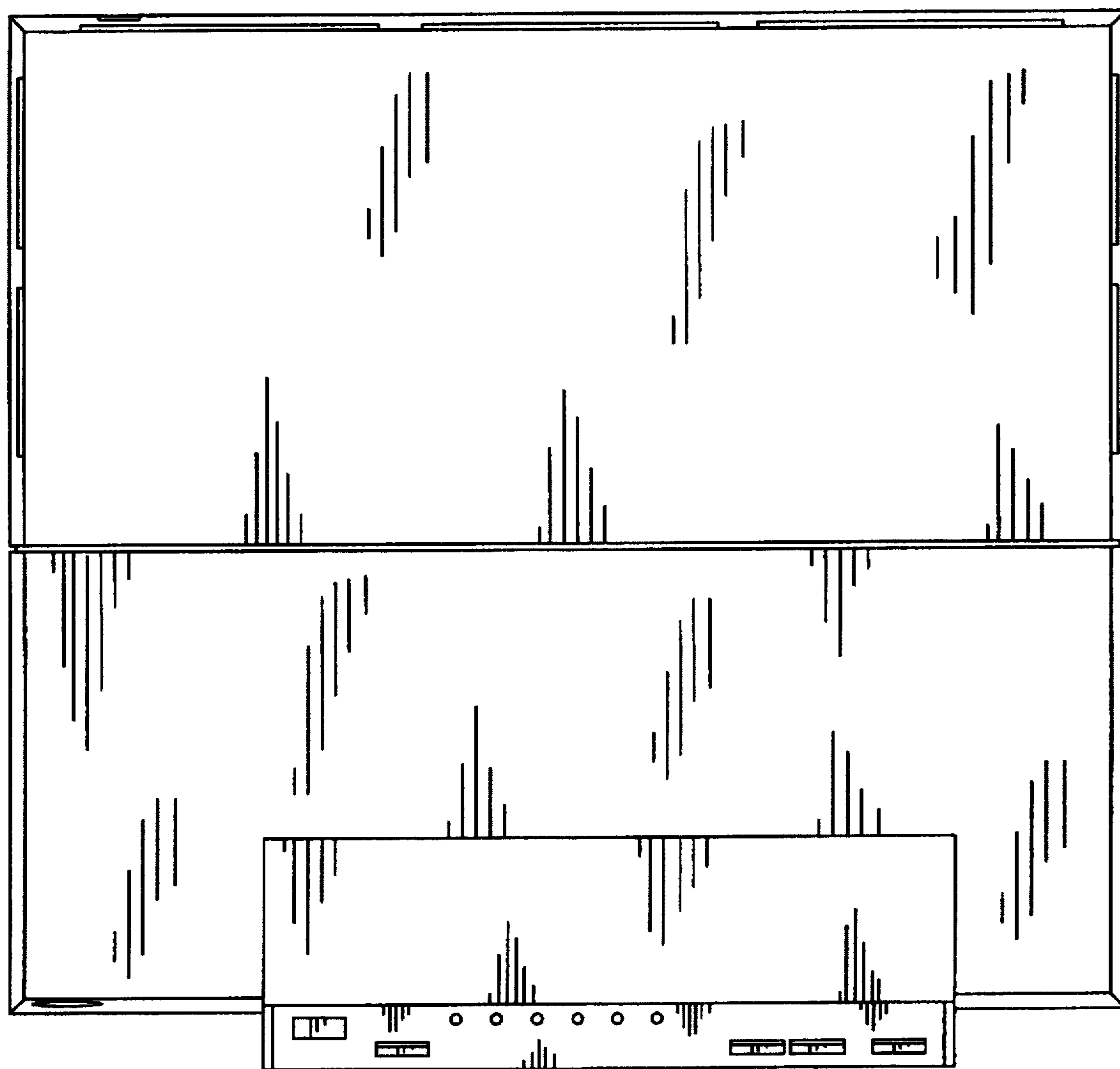

FIG. 11

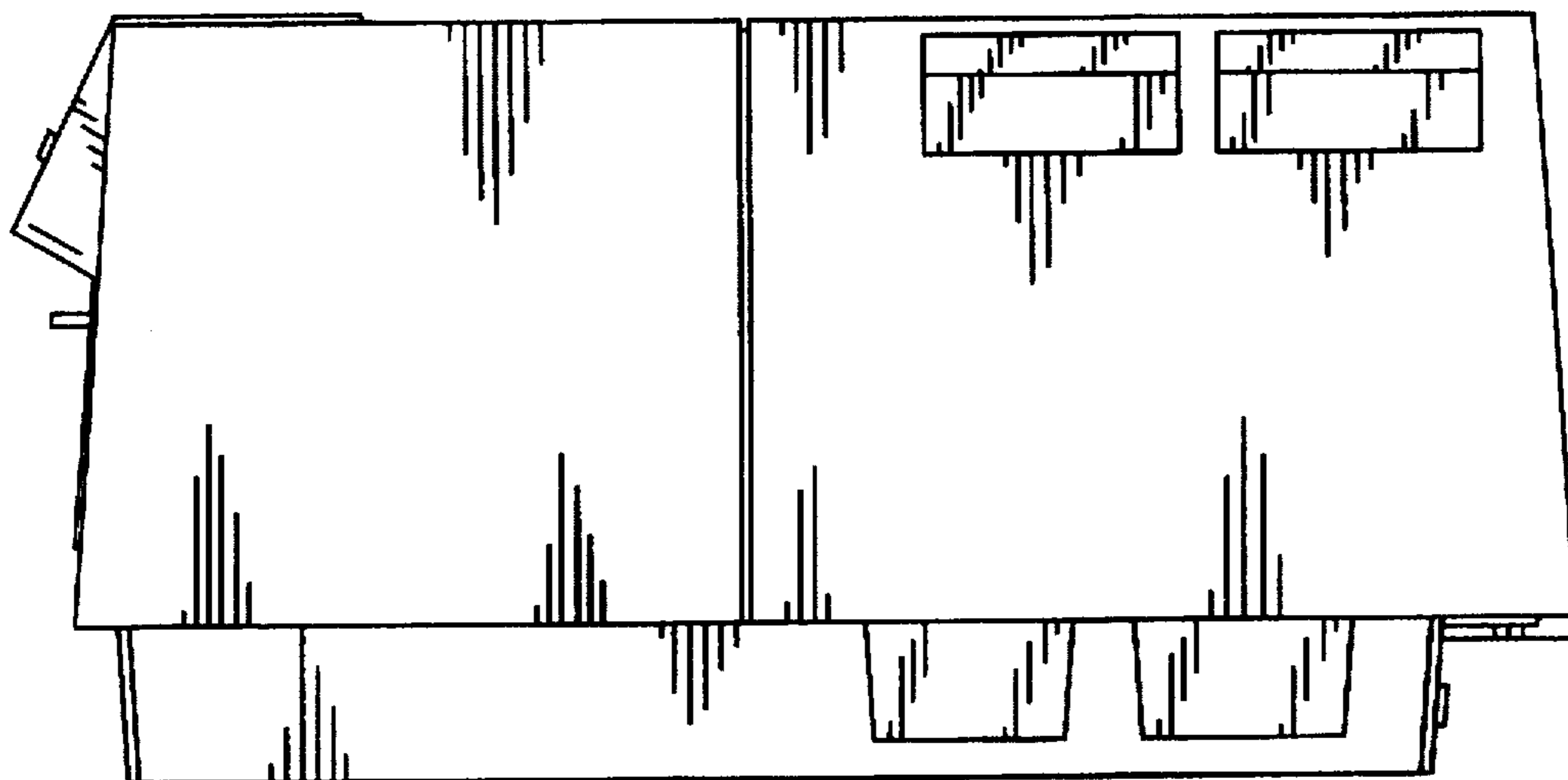

FIG. 12

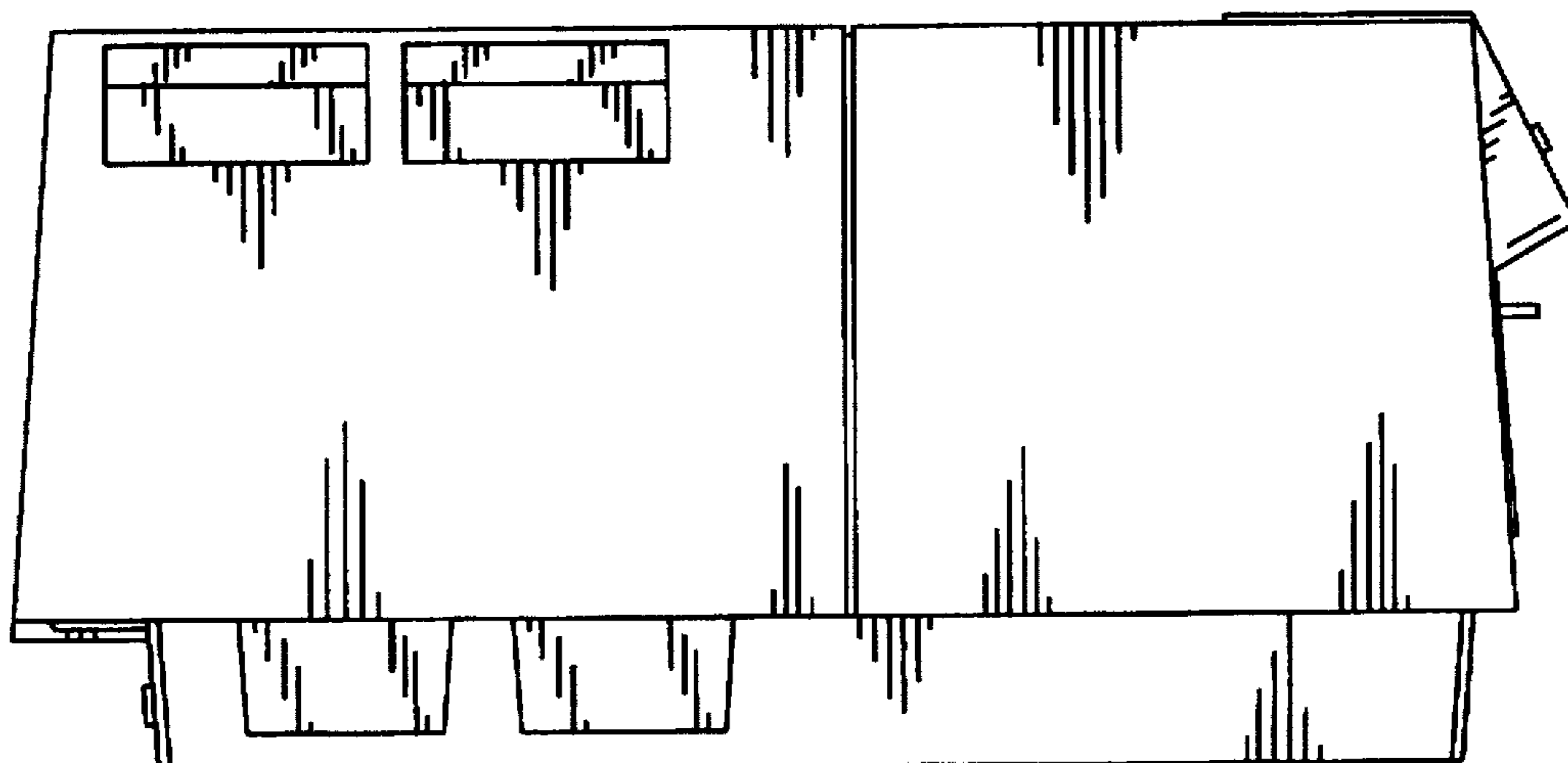

FIG. 13

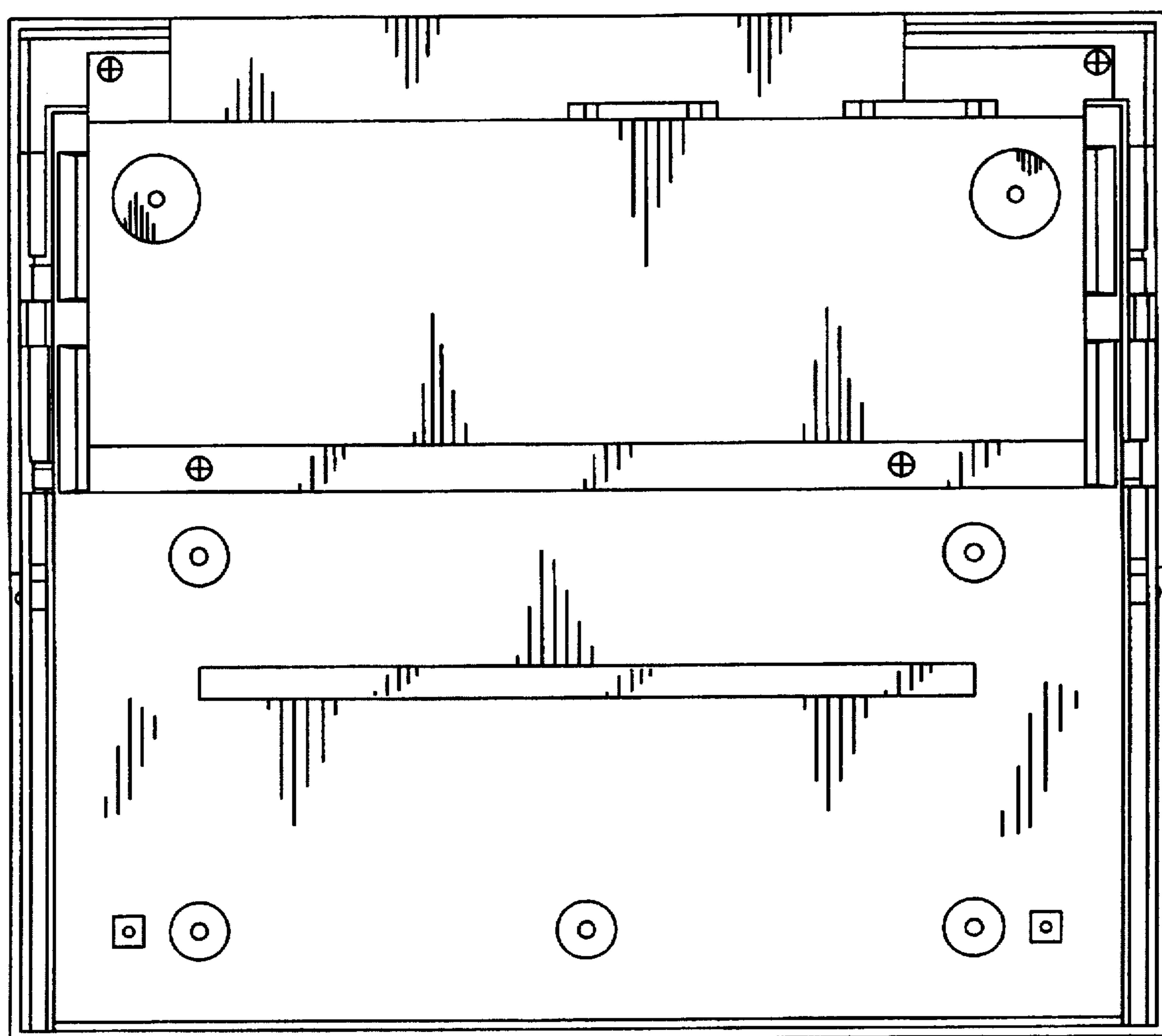

FIG. 14

