



US00D397333S

United States Patent [19] Kawai

[11] Patent Number: **Des. 397,333**
[45] Date of Patent: ****Aug. 25, 1998**

[54] **FACSIMILE TRANSMITTER-RECEIVER**

[75] Inventor: **Hideki Kawai**, Tokyo, Japan

[73] Assignee: **Canon Kabushiki Kaisha**, Japan

[**] Term: **14 Years**

[21] Appl. No.: **77,857**

[22] Filed: **Oct. 10, 1997**

[30] **Foreign Application Priority Data**

Apr. 14, 1997 [JP] Japan 9-51185

[51] **LOC (6) Cl.** **16-03**

[52] **U.S. Cl.** **D14/118**

[58] **Field of Search** D14/118, 124,
D14/299; 358/400, 401; D28/36, 37

[56] **References Cited**

U.S. PATENT DOCUMENTS

- D. 350,766 9/1994 Tomatsu et al. D14/118 X
- D. 355,405 2/1995 Takeuchi D14/118
- D. 370,479 6/1996 Omino D14/118
- D. 376,141 12/1996 Takeuchi D14/118

- D. 383,744 9/1997 Matsushima et al. D14/118
- 5,166,812 11/1992 Dow et al. 358/400 X
- 5,329,377 7/1994 Gregg 358/400

OTHER PUBLICATIONS

Panasonic, Panafax, front cover, Jun. 1994.

Primary Examiner—Prabhakar G. Deshmukh

Attorney, Agent, or Firm—Fitzpatrick, Cella, Harper & Scinto

[57] CLAIM

The ornamental design for a facsimile transmitter-receiver, as shown and described.

DESCRIPTION

FIG. 1 is a front view of a facsimile transmitter-receiver showing my new design;
 FIG. 2 is a rear view thereof;
 FIG. 3 is a top plan view thereof;
 FIG. 4 is a bottom plan view thereof;
 FIG. 5 is a left side view thereof;
 FIG. 6 is a right side view thereof; and
 FIG. 7 is a perspective view thereof.

1 Claim, 4 Drawing Sheets

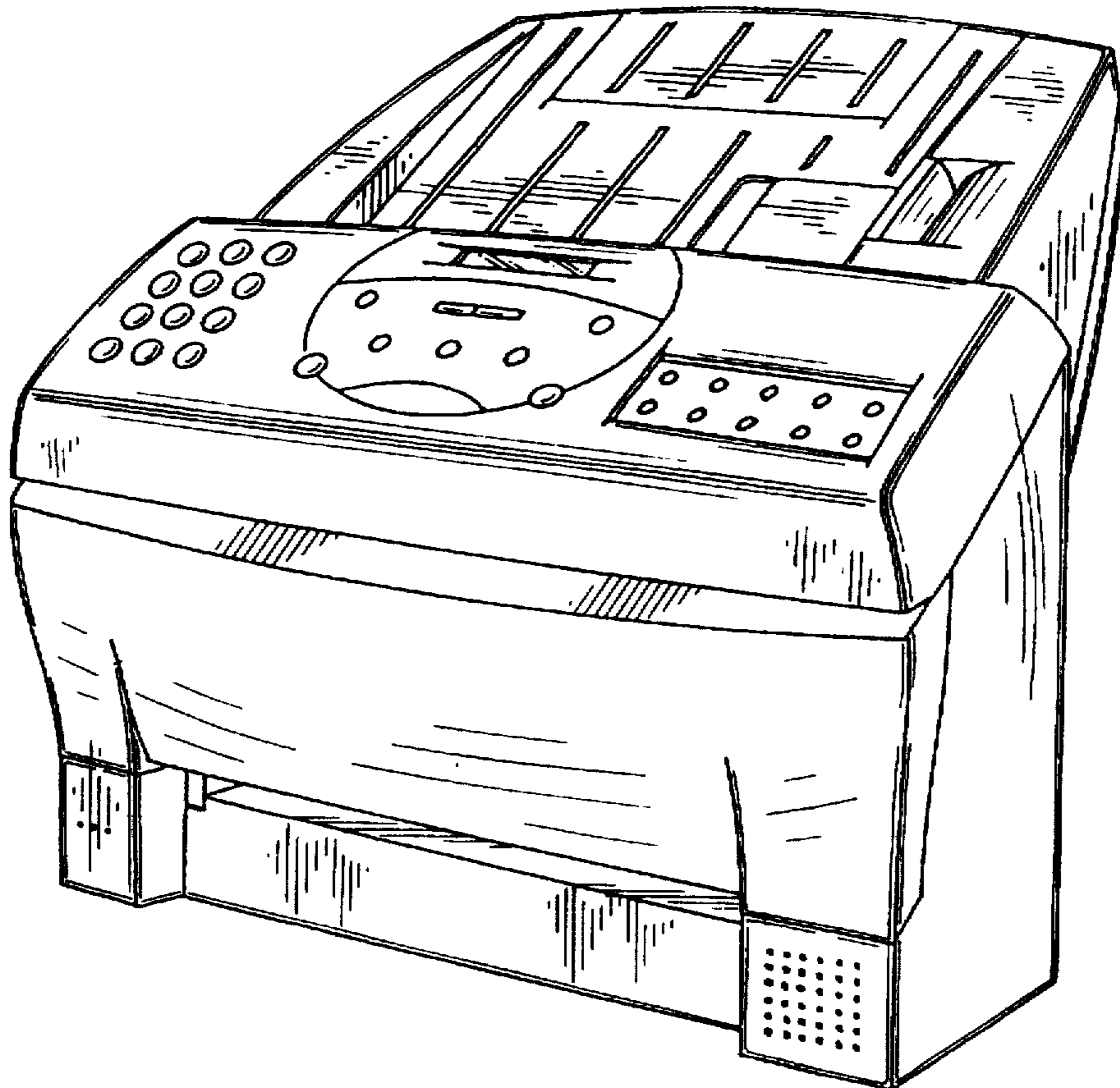

FIG. 1

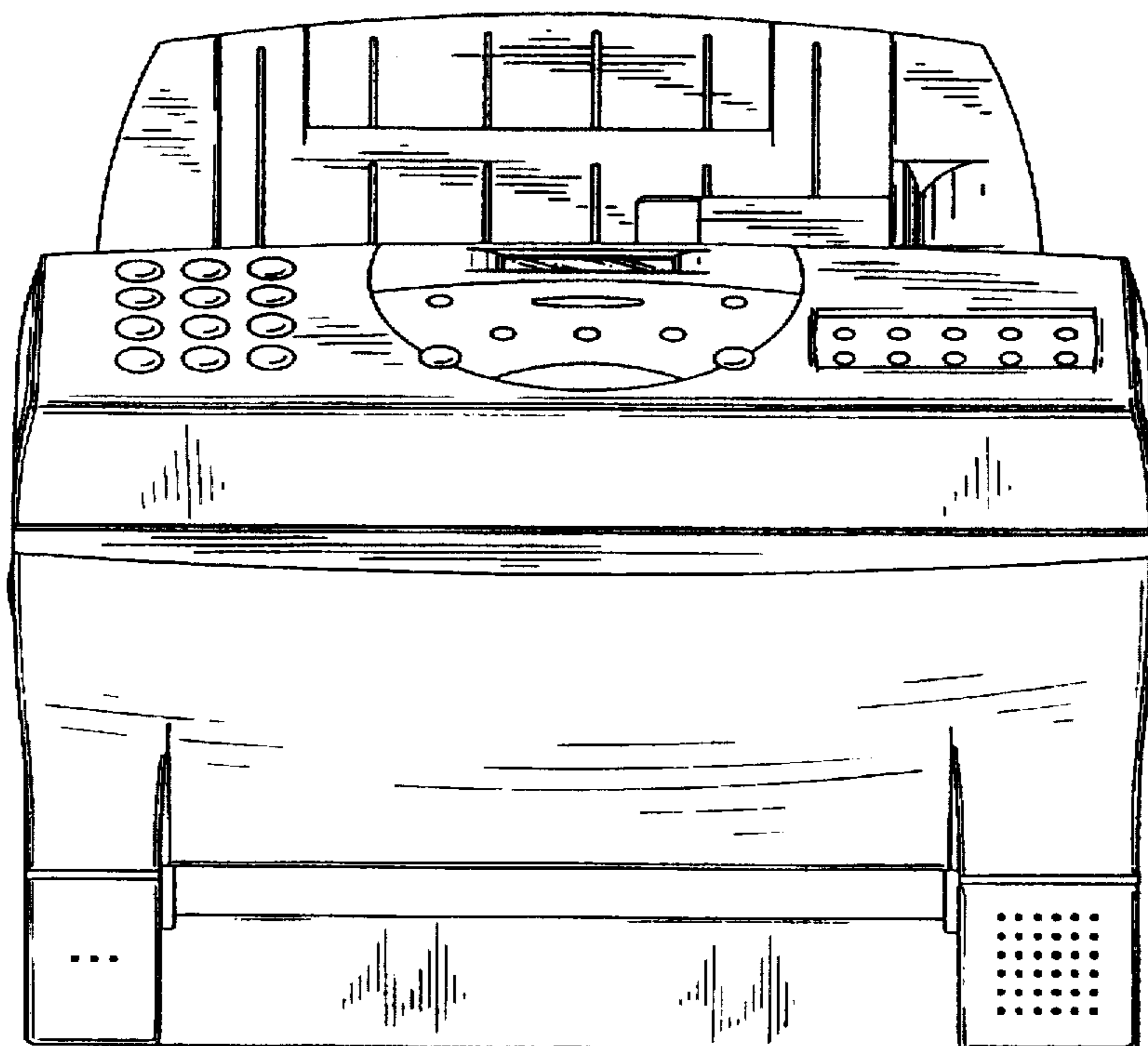

FIG. 2

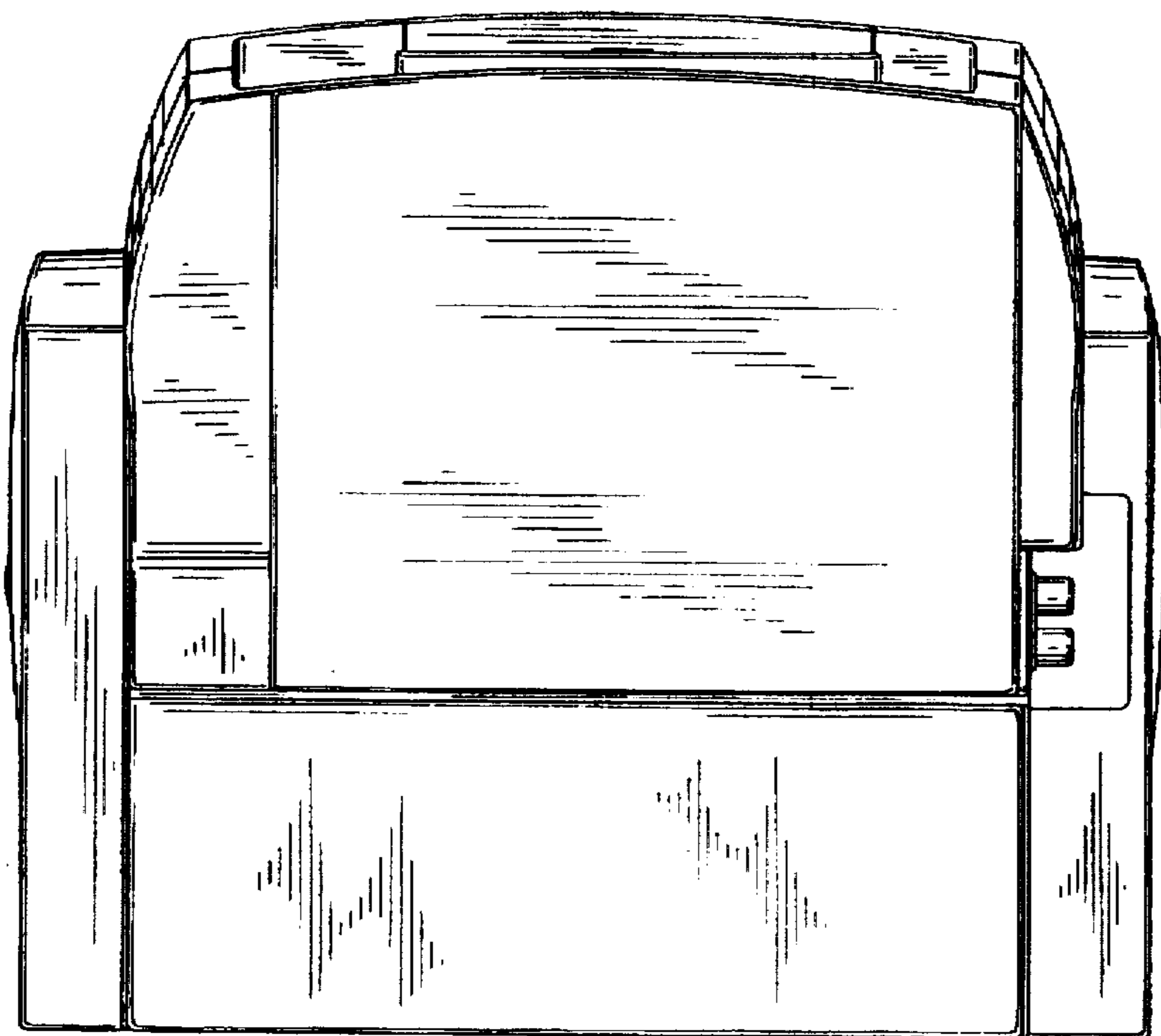

FIG. 3

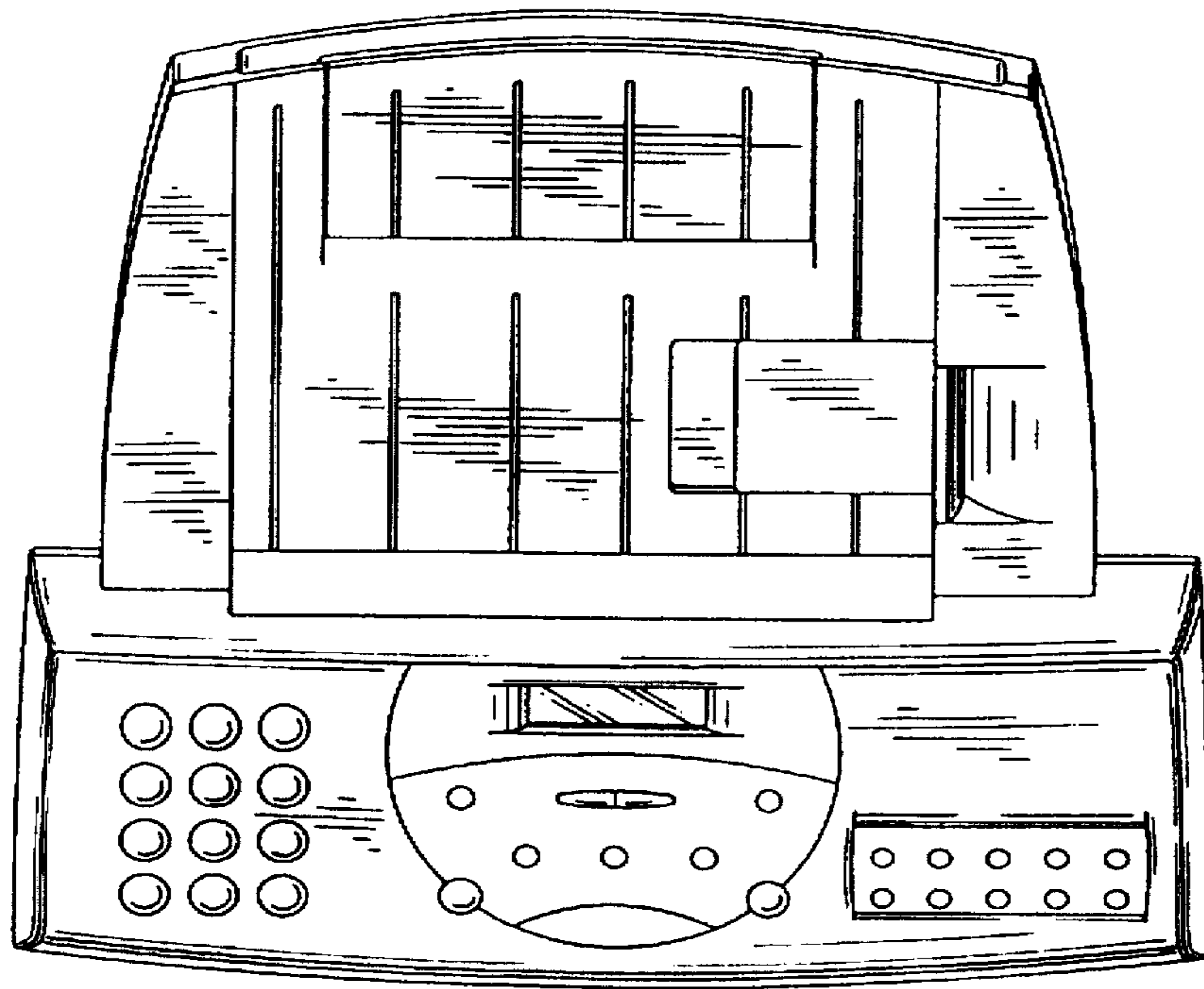

FIG. 4

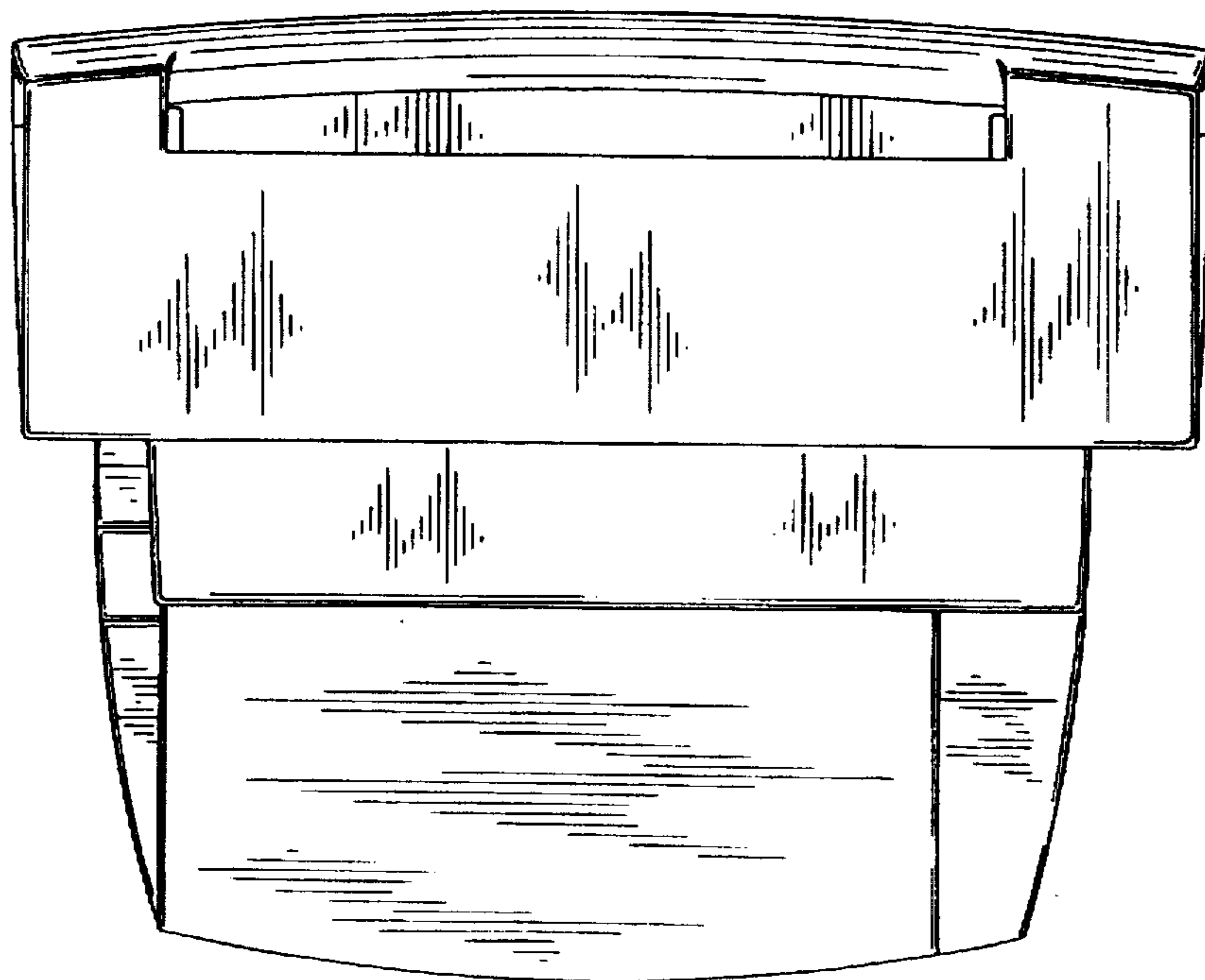

FIG. 5

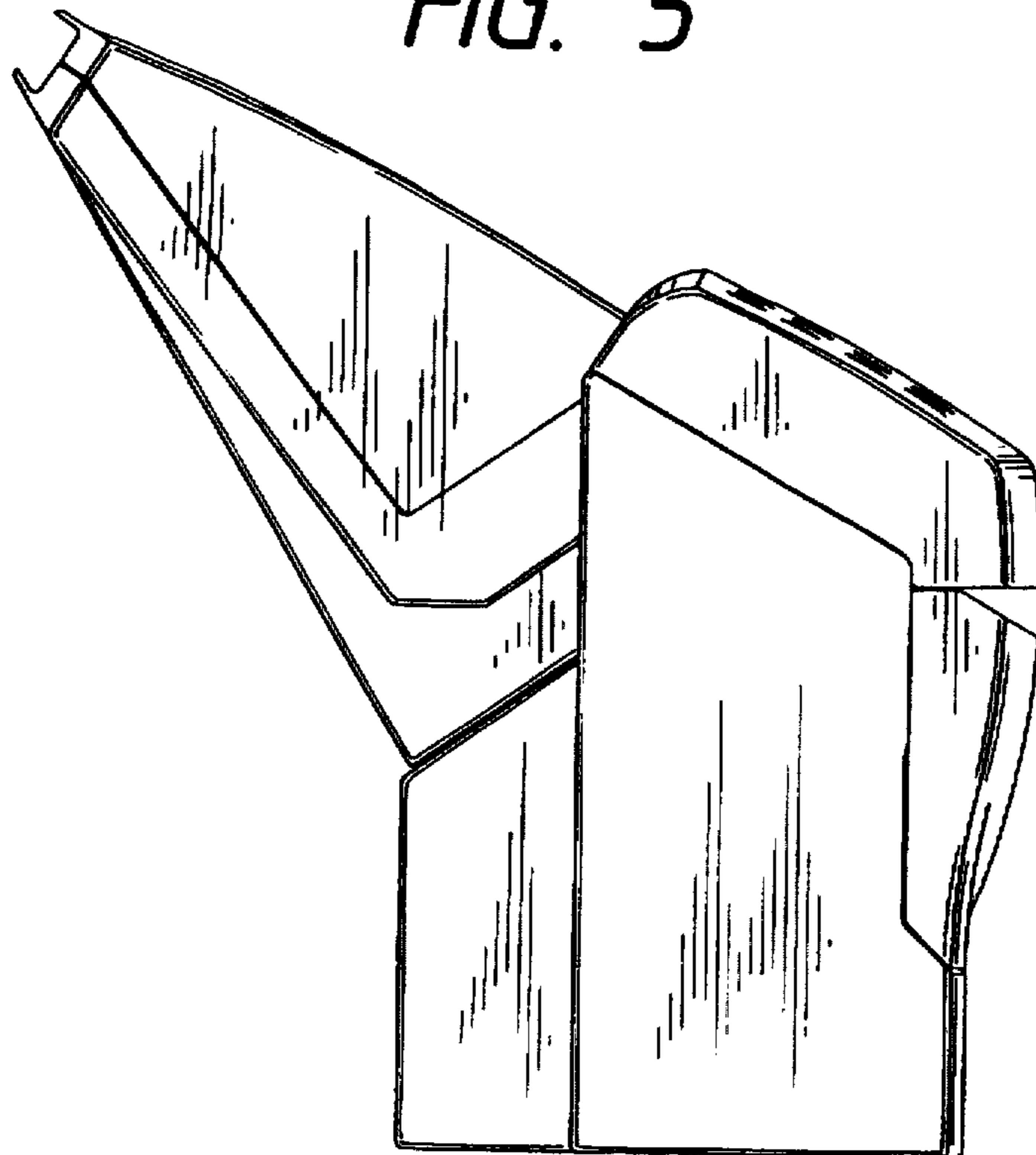

FIG. 6

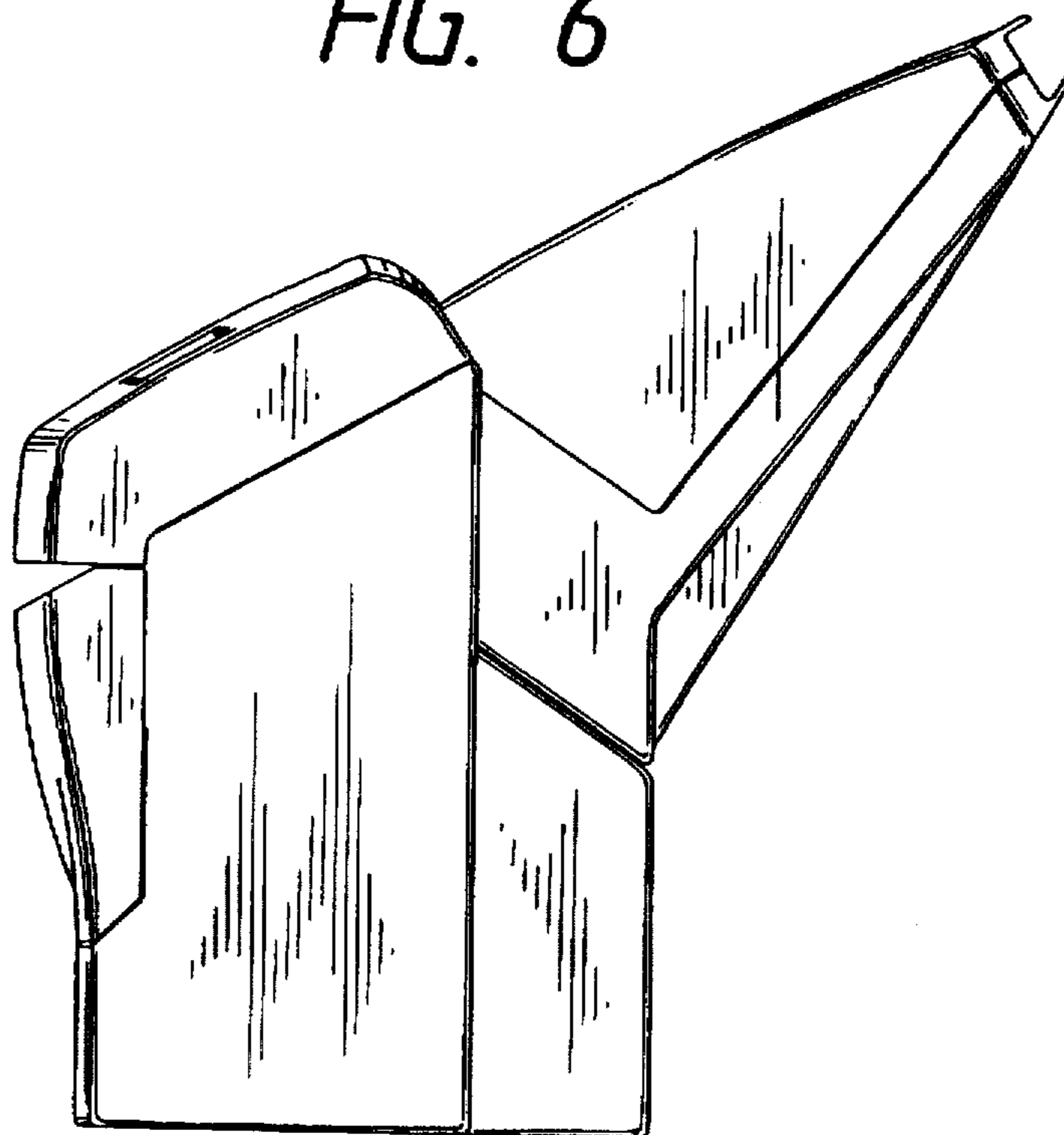

FIG. 7

