



US00D397326S

United States Patent [19]

Hill et al.

[11] Patent Number: Des. 397,326

[45] Date of Patent: **Aug. 25, 1998

[54] CONVERTIBLE DESKTOP PERSONAL COMPUTER WITH OPTIONAL BASE

[75] Inventors: David Wayne Hill, Cary; Susan Sommers Moffatt, Chapel Hill, both of N.C.

[73] Assignee: International Business Machines Corp., Armonk, N.Y.

[**] Term: 14 Years

[21] Appl. No.: 77,892

[22] Filed: Oct. 14, 1997

[51] LOC (6) Cl. 14-02

[52] U.S. Cl. D14/100

[58] Field of Search D14/100, 102, D14/107-109; D13/162, 184, 199; D6/432, 436, 445, 448; 312/208.1; 360/99.12; 361/690-696, 683, 685, 730, 732, 736

[56] References Cited

U.S. PATENT DOCUMENTS

D. 307,266	4/1990	Hara et al.	D14/100
D. 351,147	10/1994	Hill	D14/109
D. 362,237	9/1995	Nakada	D14/109 X
D. 364,851	12/1995	Moffatt et al.	D14/100
D. 370,210	5/1996	Cindrich et al.	D14/109 X

Primary Examiner—Freda Nunn
Attorney, Agent, or Firm—George E. Grosser

[57] CLAIM

The ornamental design for a convertible desktop personal computer with optional base, as shown and described.

DESCRIPTION

FIG. 1 is a front, top and left side view of a convertible desktop personal computer with optional base according to the present invention;
 FIG. 2 is a front elevational view thereof;
 FIG. 3 is a left side view thereof;
 FIG. 4 is a right side elevational view thereof;
 FIG. 5 is a top plan view thereof;
 FIG. 6 is a rear elevational view thereof;
 FIG. 7 is a bottom plan view thereof;
 FIG. 8 is a front, top and left side view of the convertible desktop personal computer with optional base according to the present invention with optional base detached;
 FIG. 9 is a front elevational view thereof;
 FIG. 10 is a left side view thereof;
 FIG. 11 is a right side elevational view thereof;
 FIG. 12 is a top plan view thereof;
 FIG. 13 is a rear elevational view thereof; and,
 FIG. 14 is a bottom plan view thereof.

1 Claim, 14 Drawing Sheets

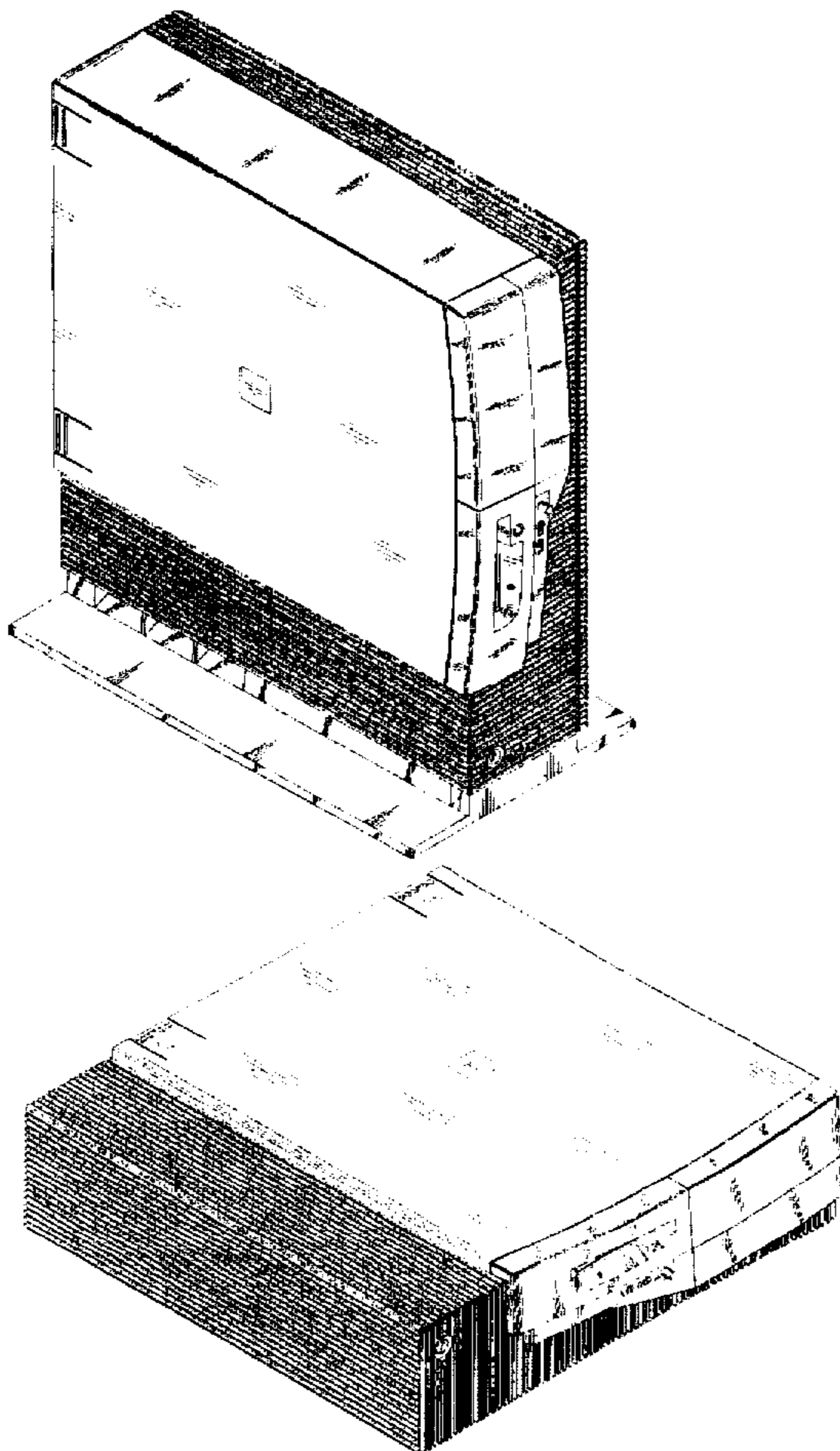
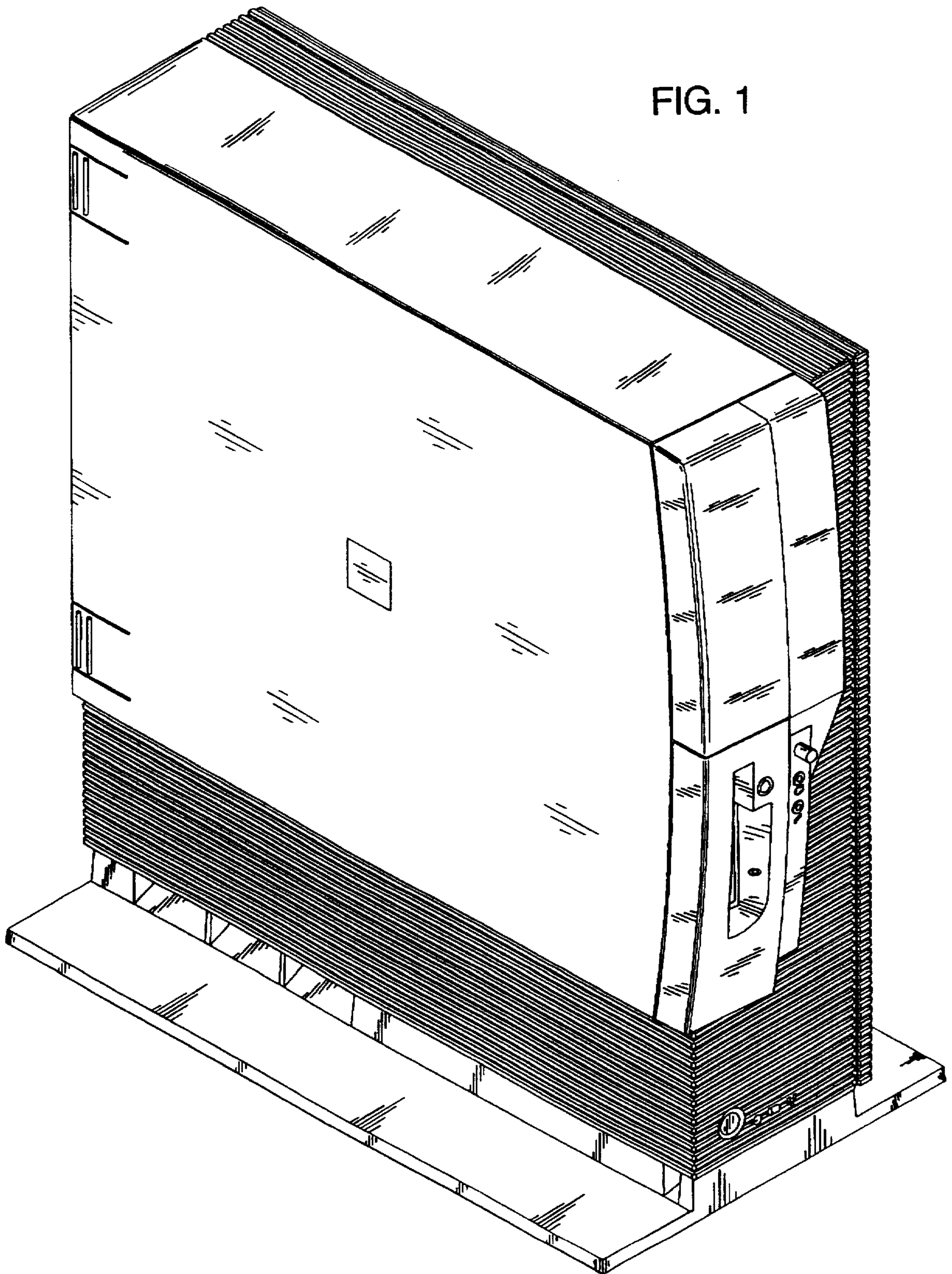

FIG. 1



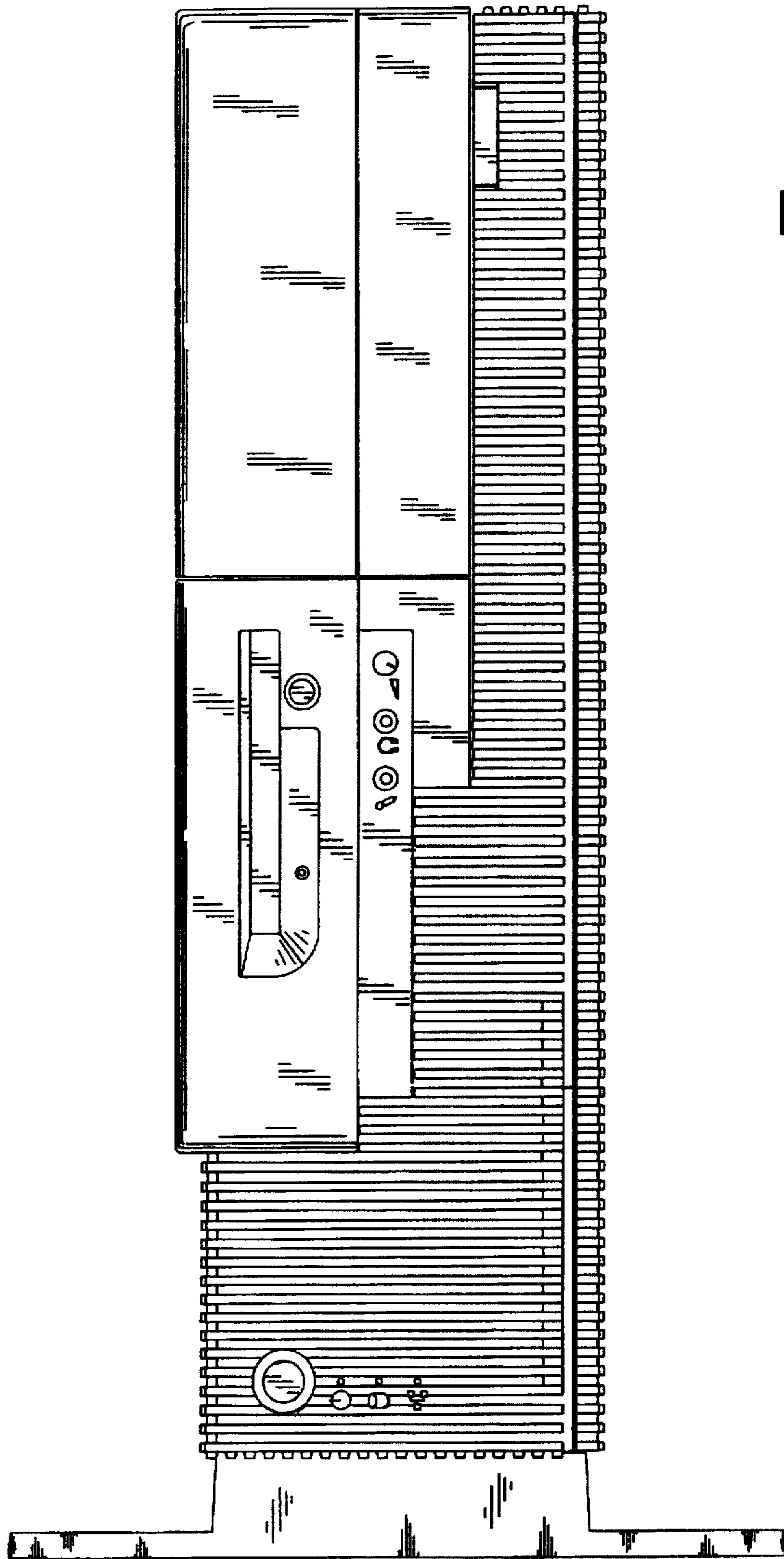

FIG. 2

FIG. 3

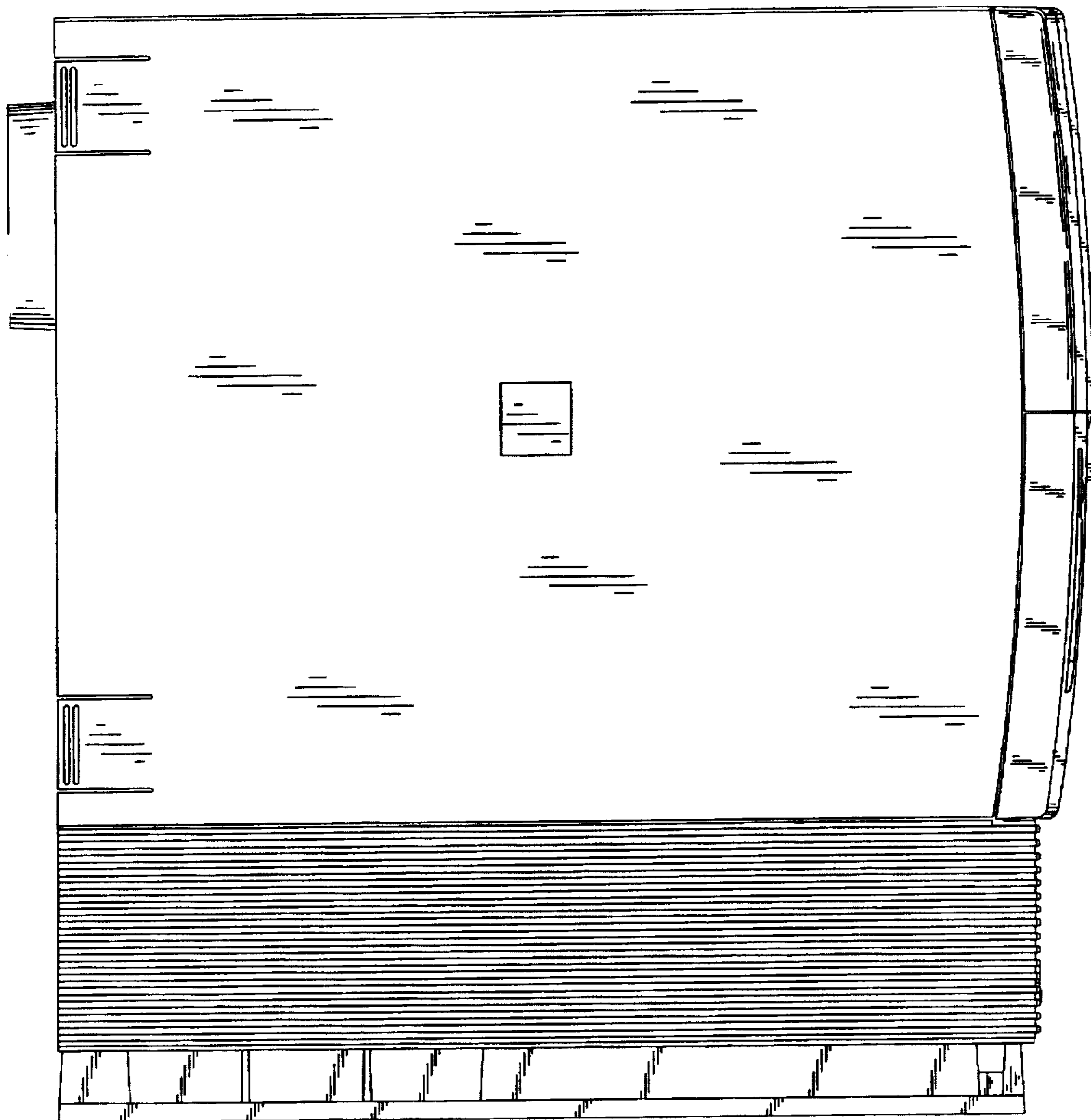

FIG. 4

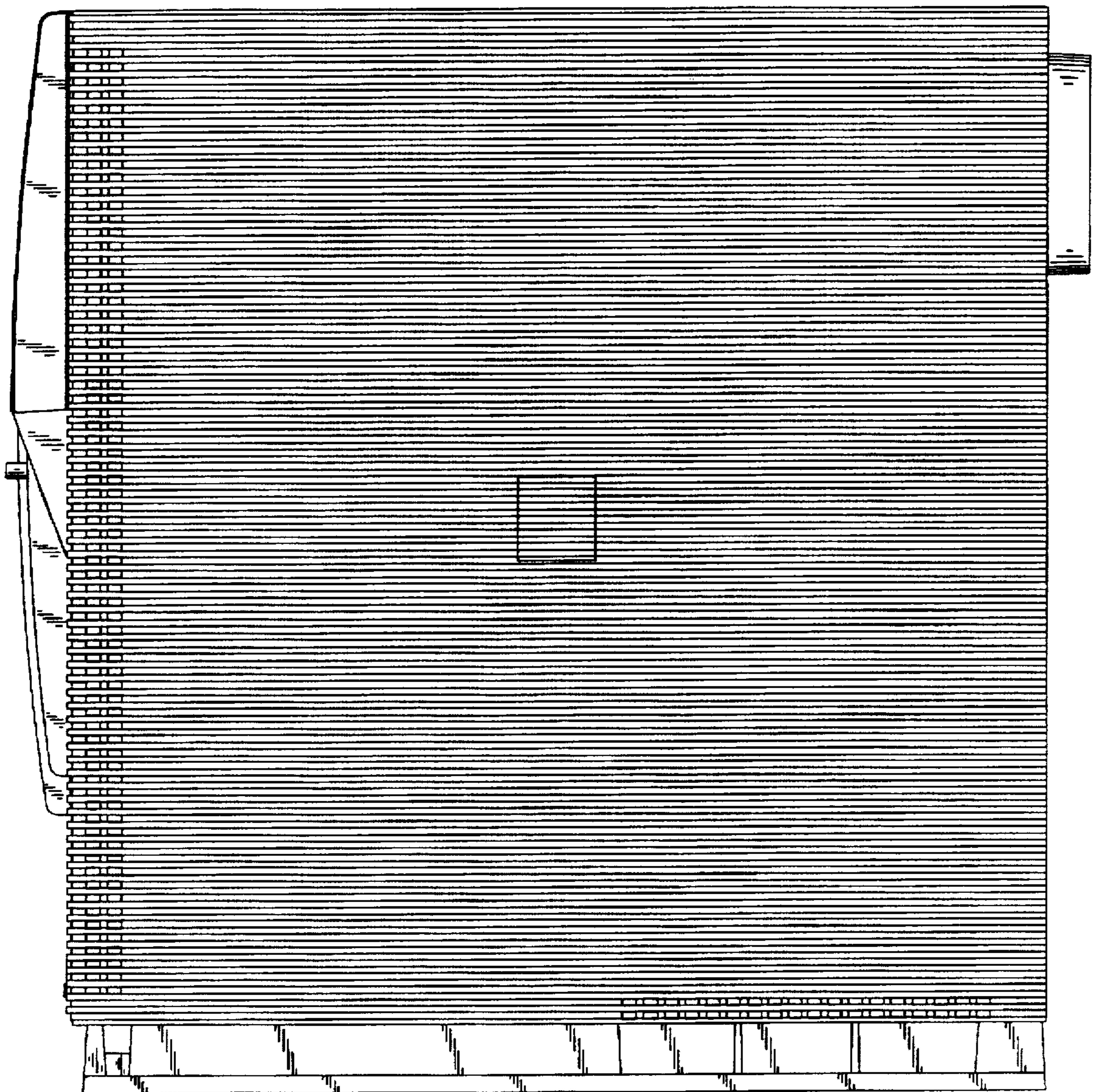

FIG. 5

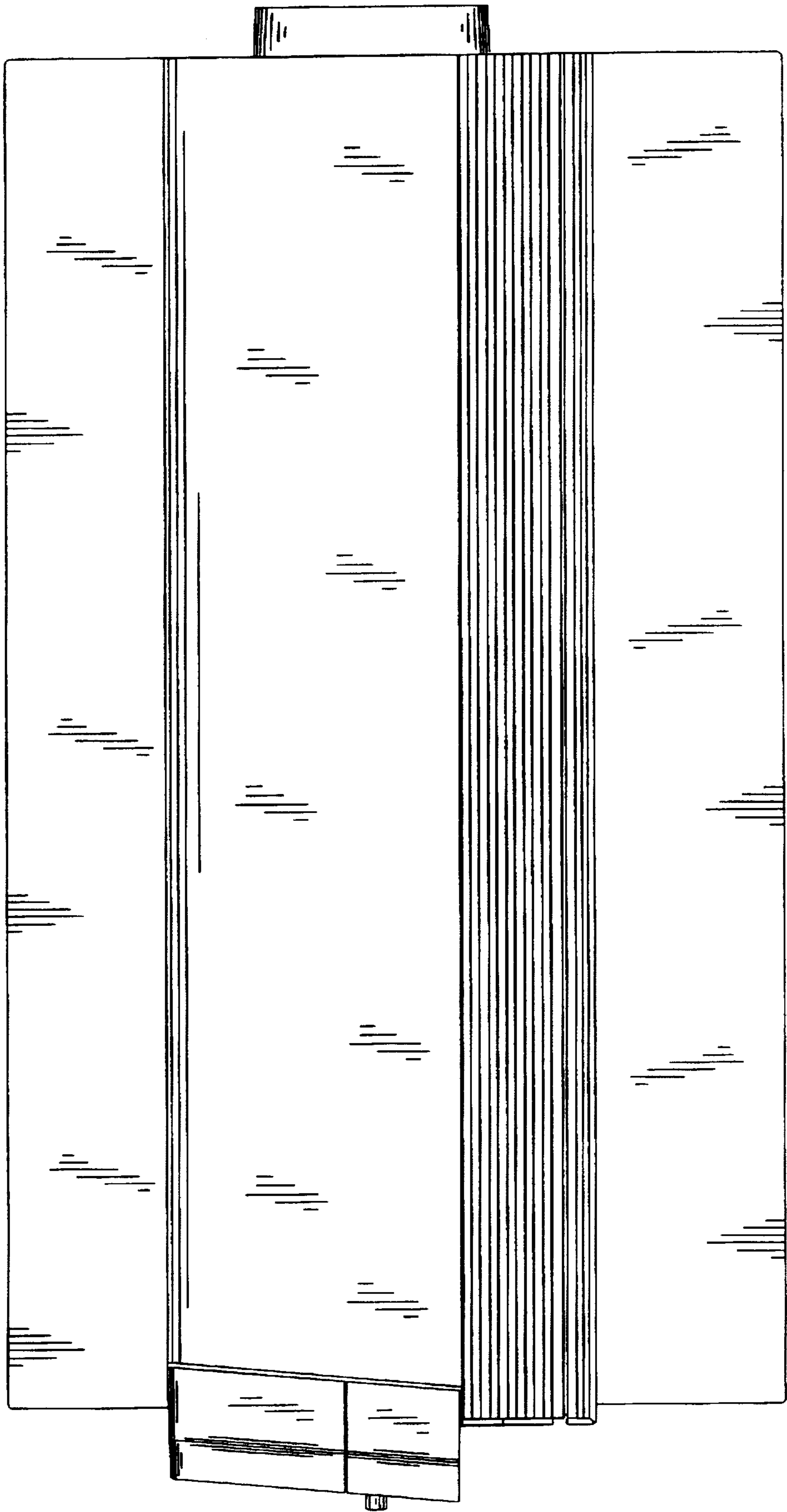
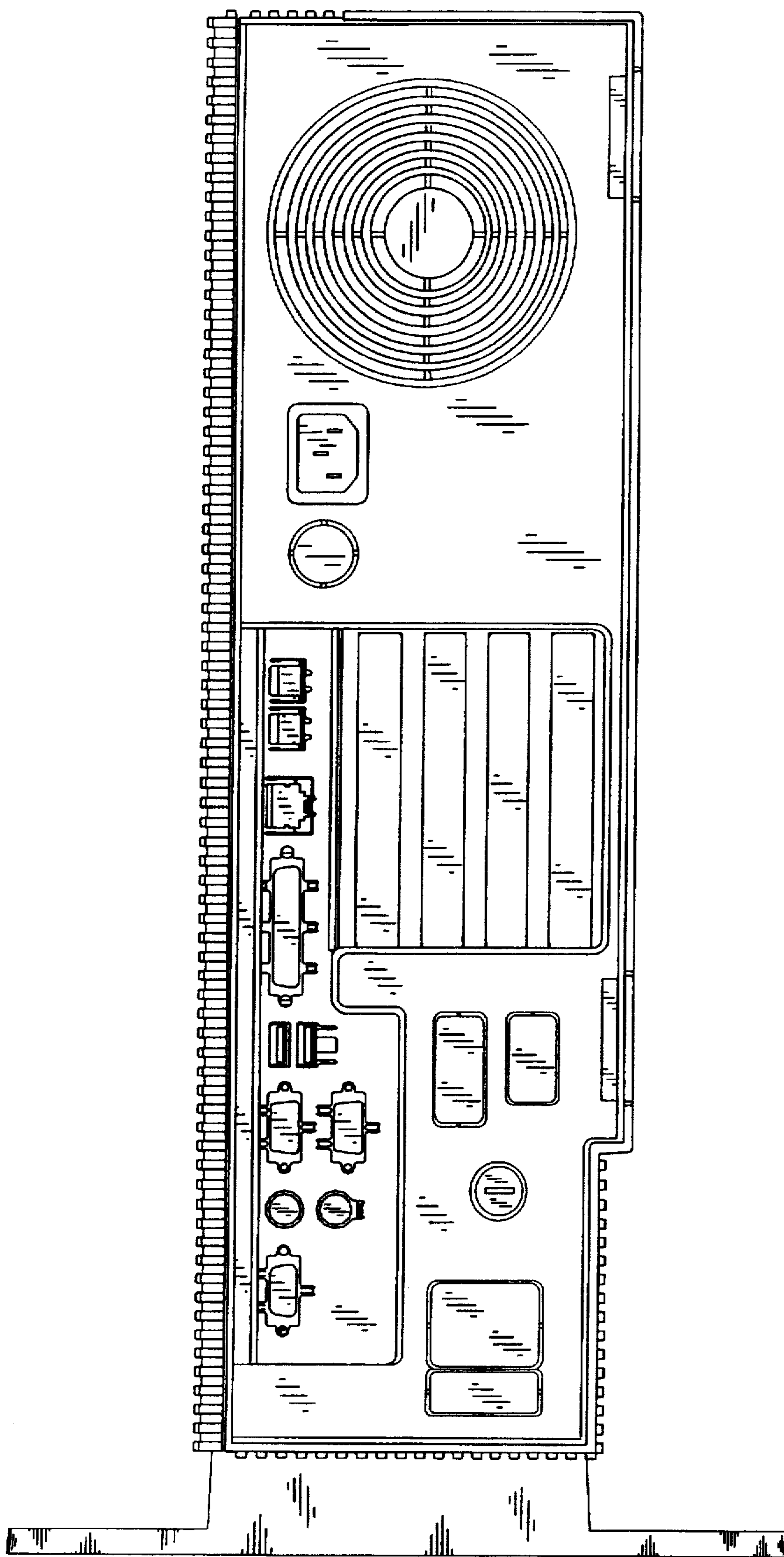

FIG. 6



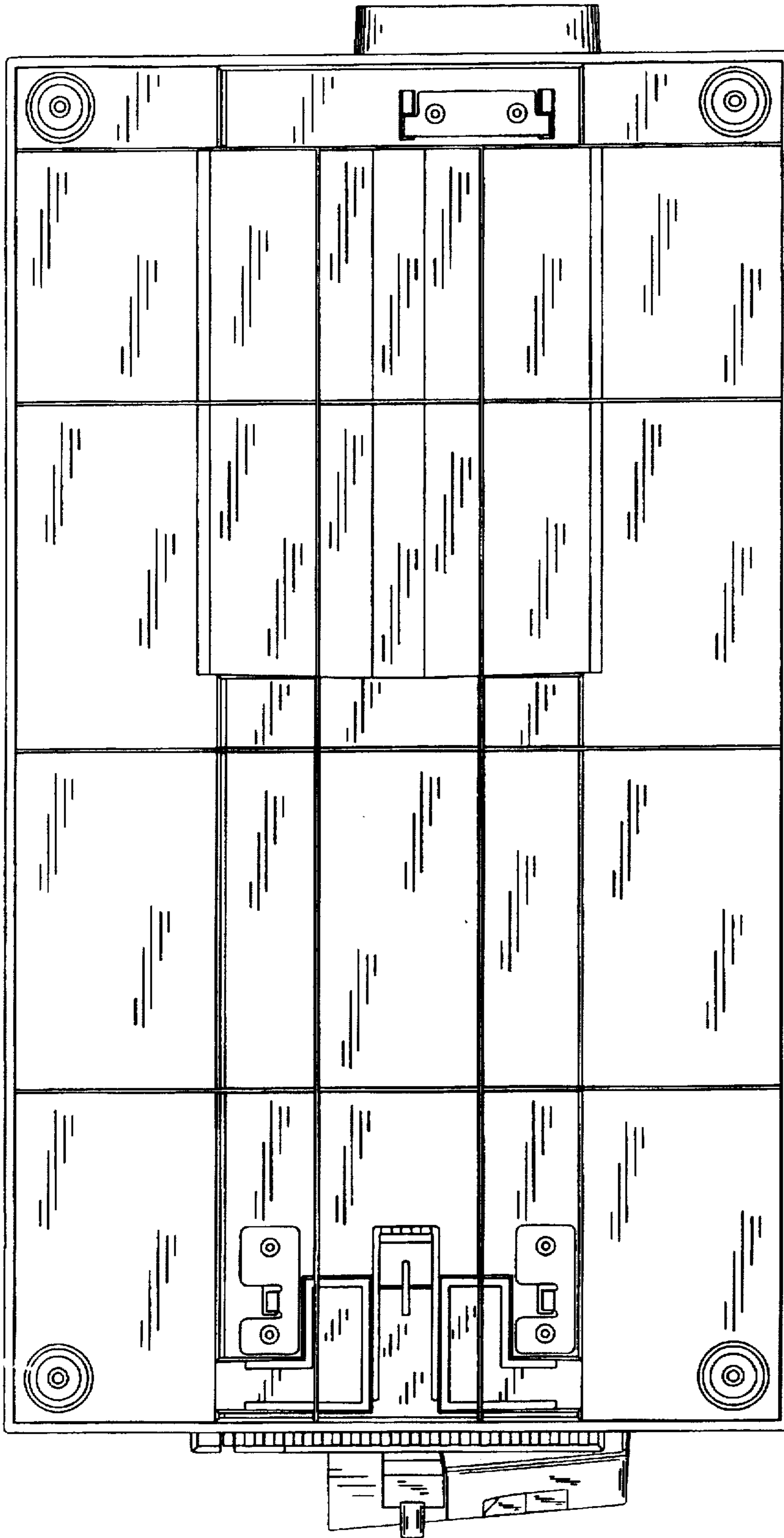

FIG. 7

FIG. 8

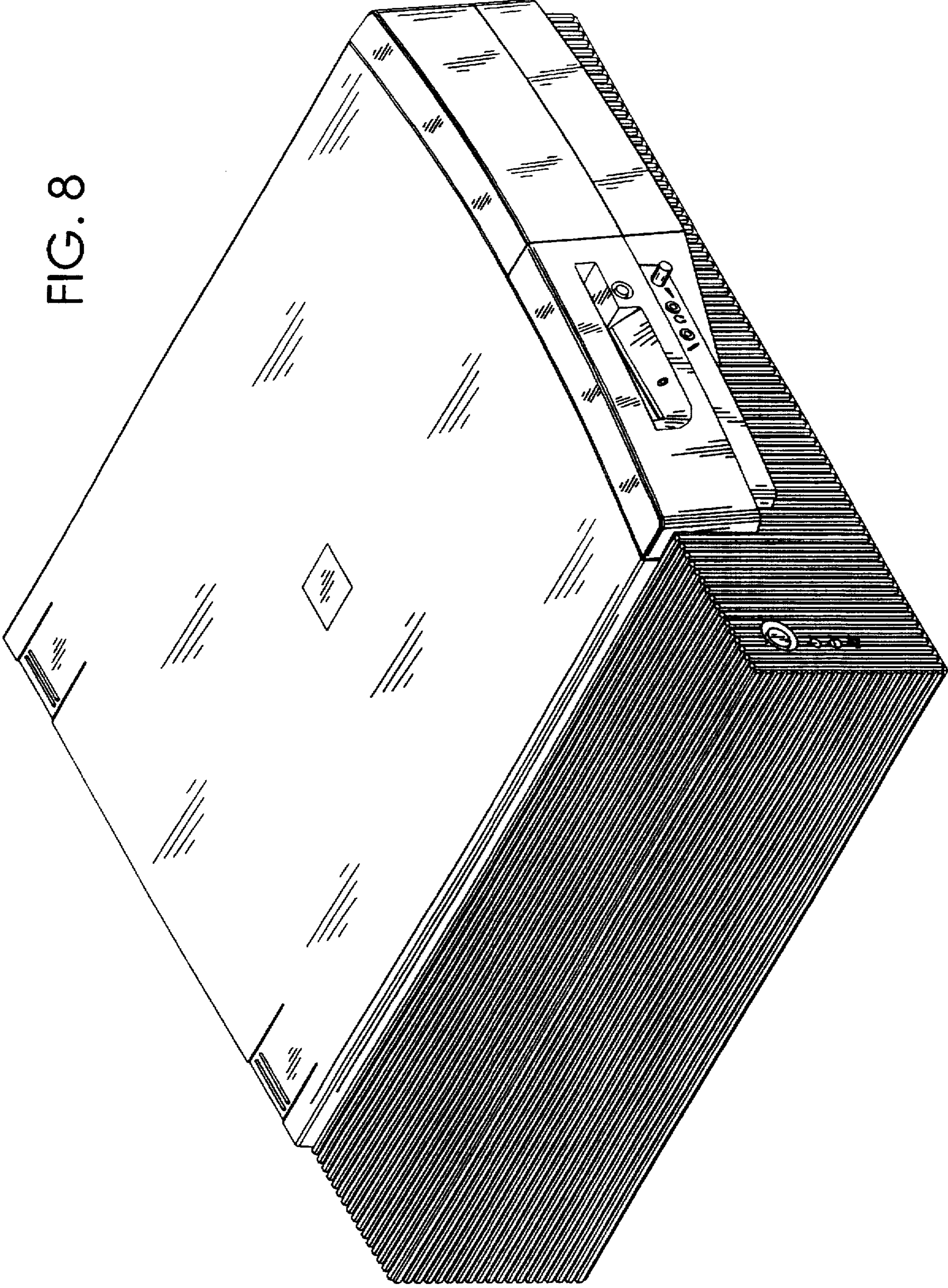

FIG. 9

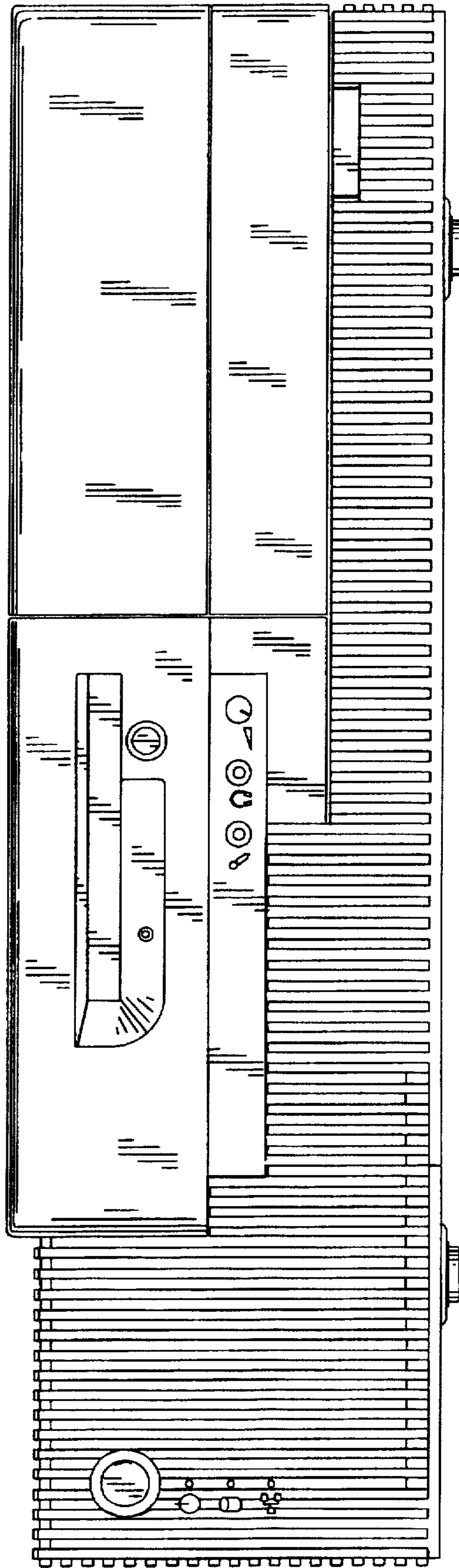

FIG. 10

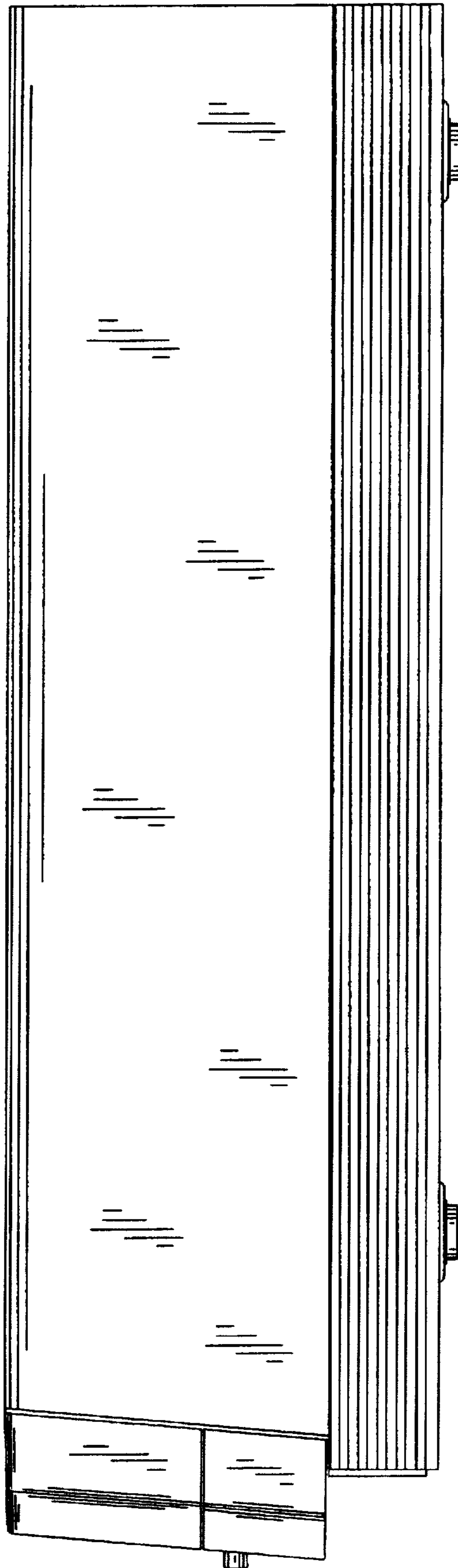

FIG. 11

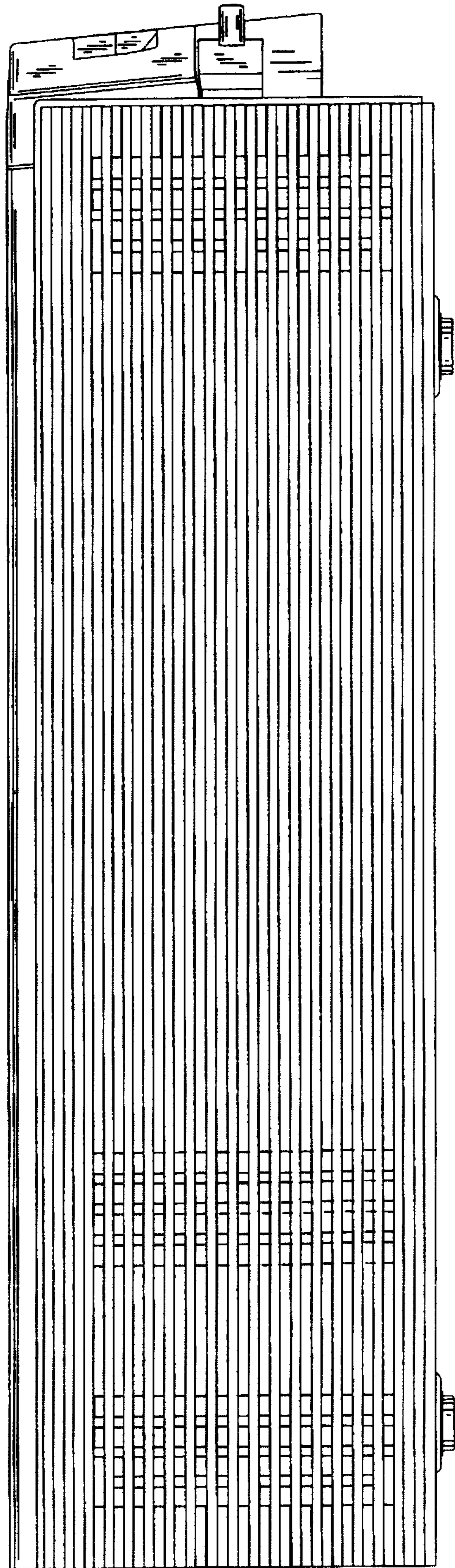

FIG. 12

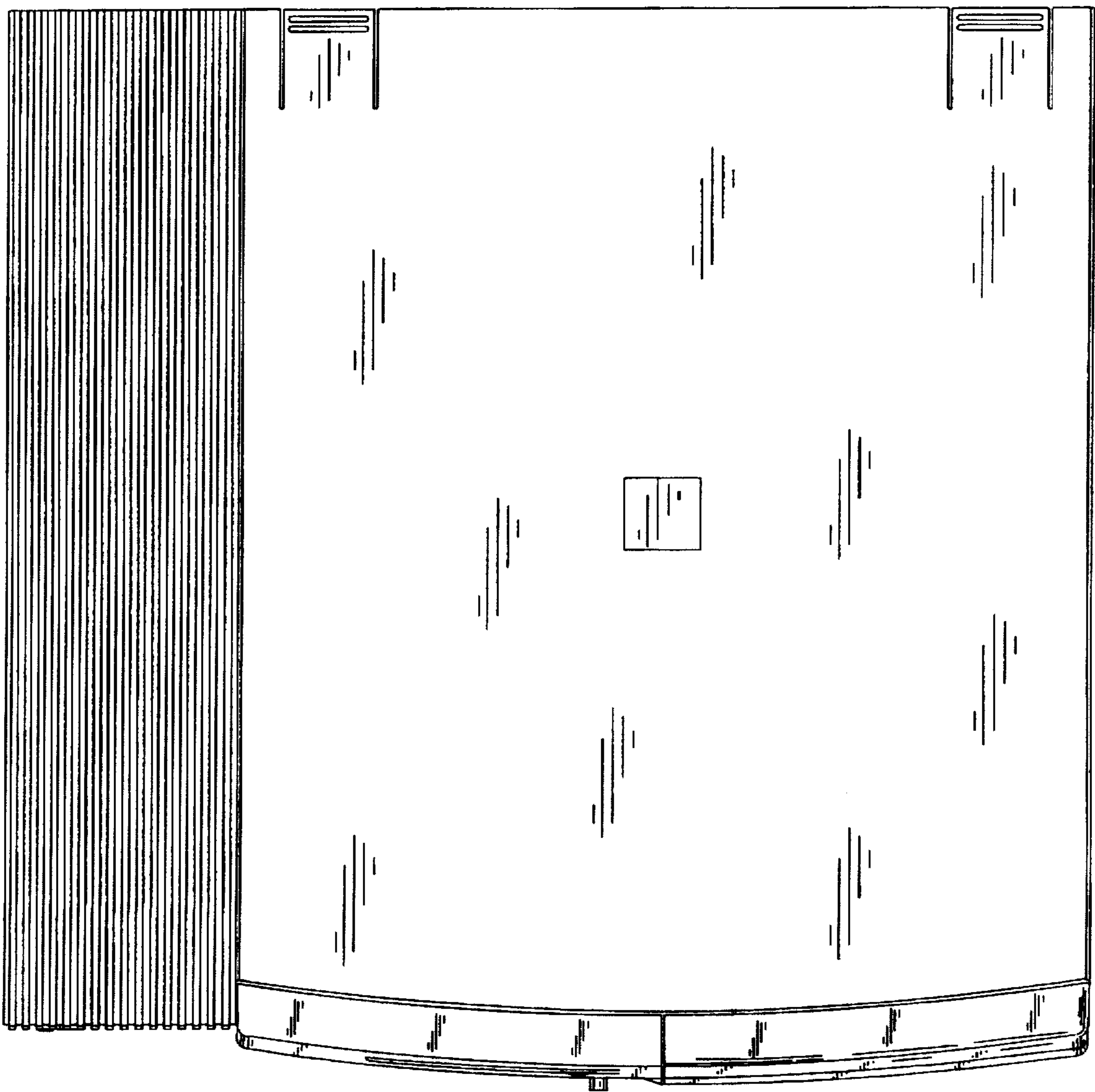

FIG. 13

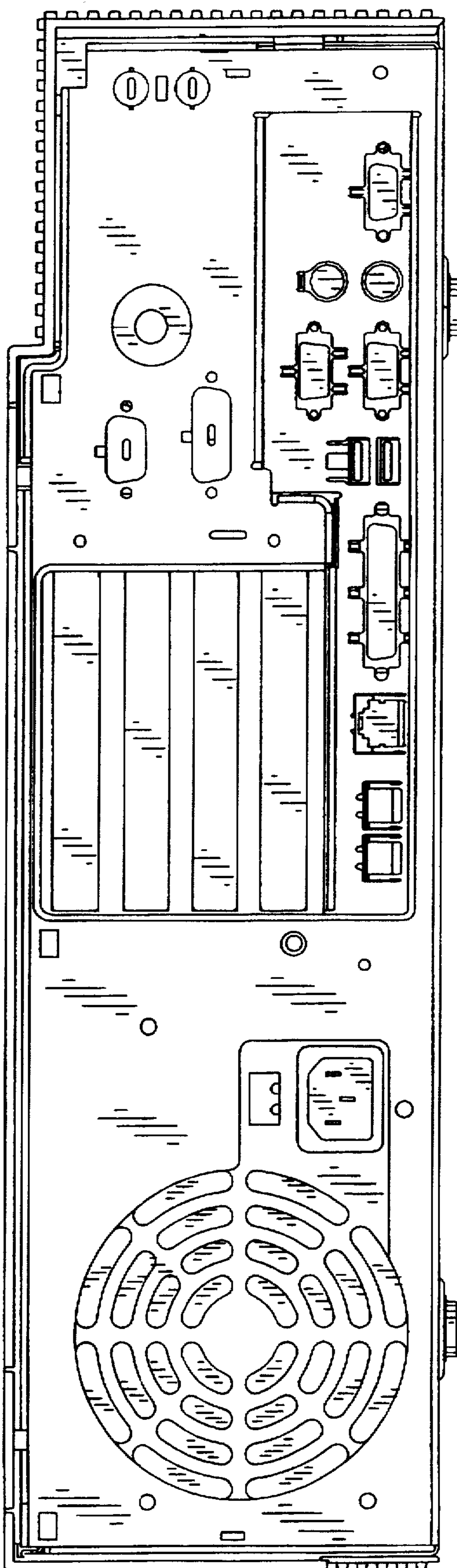

FIG. 14

