

US00D397293S

United States Patent [19]

[11] Patent Number: **Des. 397,293**

Shimizu

[45] Date of Patent: ****Aug. 25, 1998**

[54] STORAGE CASE FOR INK CARTRIDGE

D. 355,849	2/1995	Trower et al.	D9/424
D. 381,512	7/1997	Green	D9/424 X
4,623,071	11/1986	Malcolm	220/4.22 X
5,245,916	9/1993	Elizondo et al.	220/4.22 X

[75] Inventor: **Hisakazu Shimizu**, Yokohama, Japan

[73] Assignee: **Canon Kabushiki Kaisha**, Tokyo, Japan

Primary Examiner—Prabhakar G. Deshmukh
Attorney, Agent, or Firm—Fitzpatrick, Cella, Harper & Scinto

[**] Term: **14 Years**

[21] Appl. No.: **76,289**

[57] CLAIM

[22] Filed: **Sep. 4, 1997**

The ornamental design for a storage case for ink cartridge, as shown and described.

[51] LOC (6) Cl. **09-07**

DESCRIPTION

[52] U.S. Cl. **D9/424**

[58] Field of Search D9/424, 425, 432, D9/337; D3/201, 905; D18/43, 44, 36; 206/384, 730, 731, 508; 220/1.5, 376, 675, 4.22, 4.01, 253

FIG. 1 is a front view of a storage case for ink cartridge showing my new design;
FIG. 2 is a rear view thereof;
FIG. 3 is a top plan view thereof;
FIG. 4 is a bottom plan view thereof;
FIG. 5 is a left side view thereof;
FIG. 6 is a right side view thereof; and
FIG. 7 is a perspective view thereof.

[56] References Cited

U.S. PATENT DOCUMENTS

D. 252,557	8/1979	Walker et al.	D18/43
D. 312,271	11/1990	Komada et al.	D18/43

1 Claim, 3 Drawing Sheets

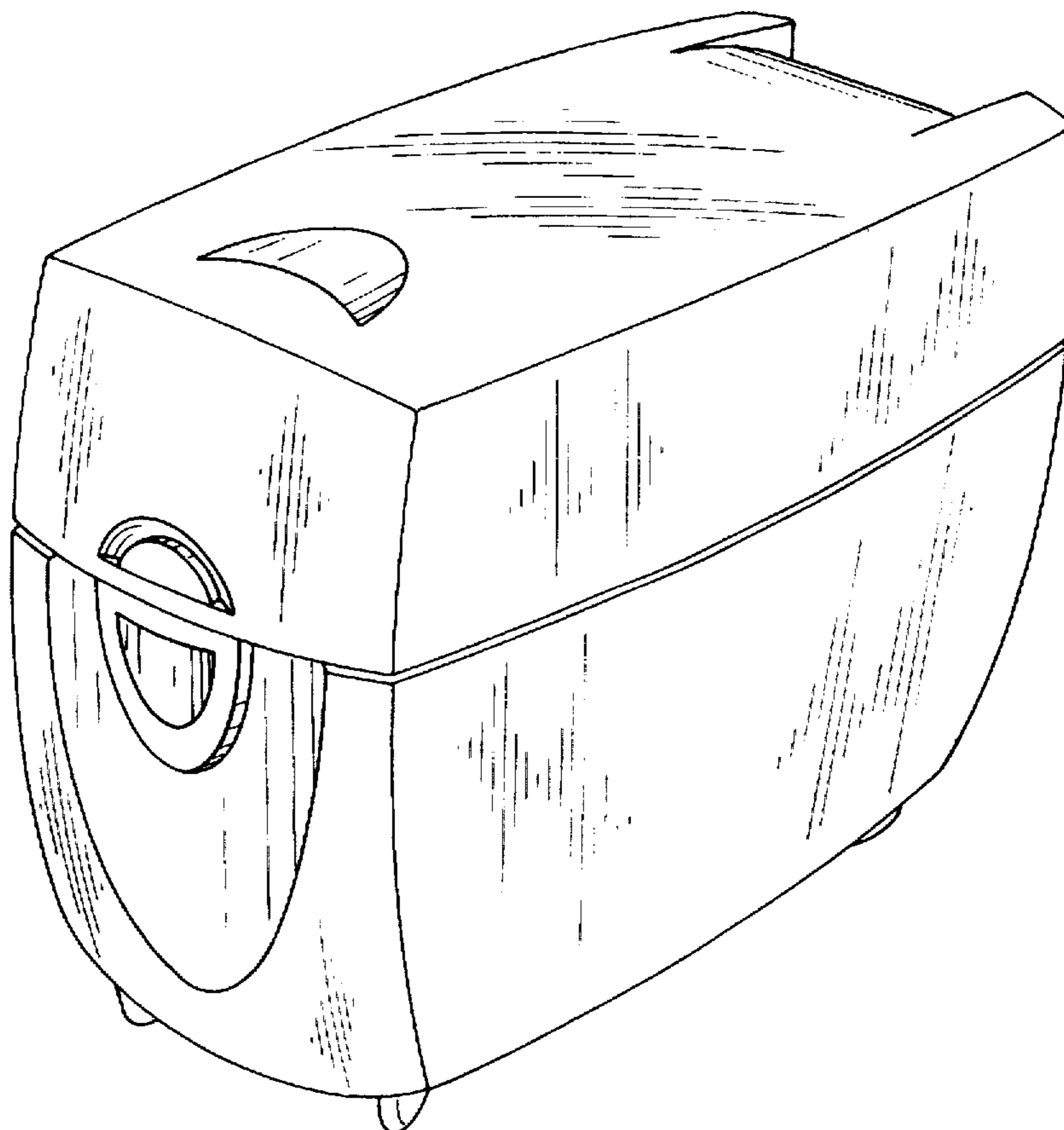

FIG. 1

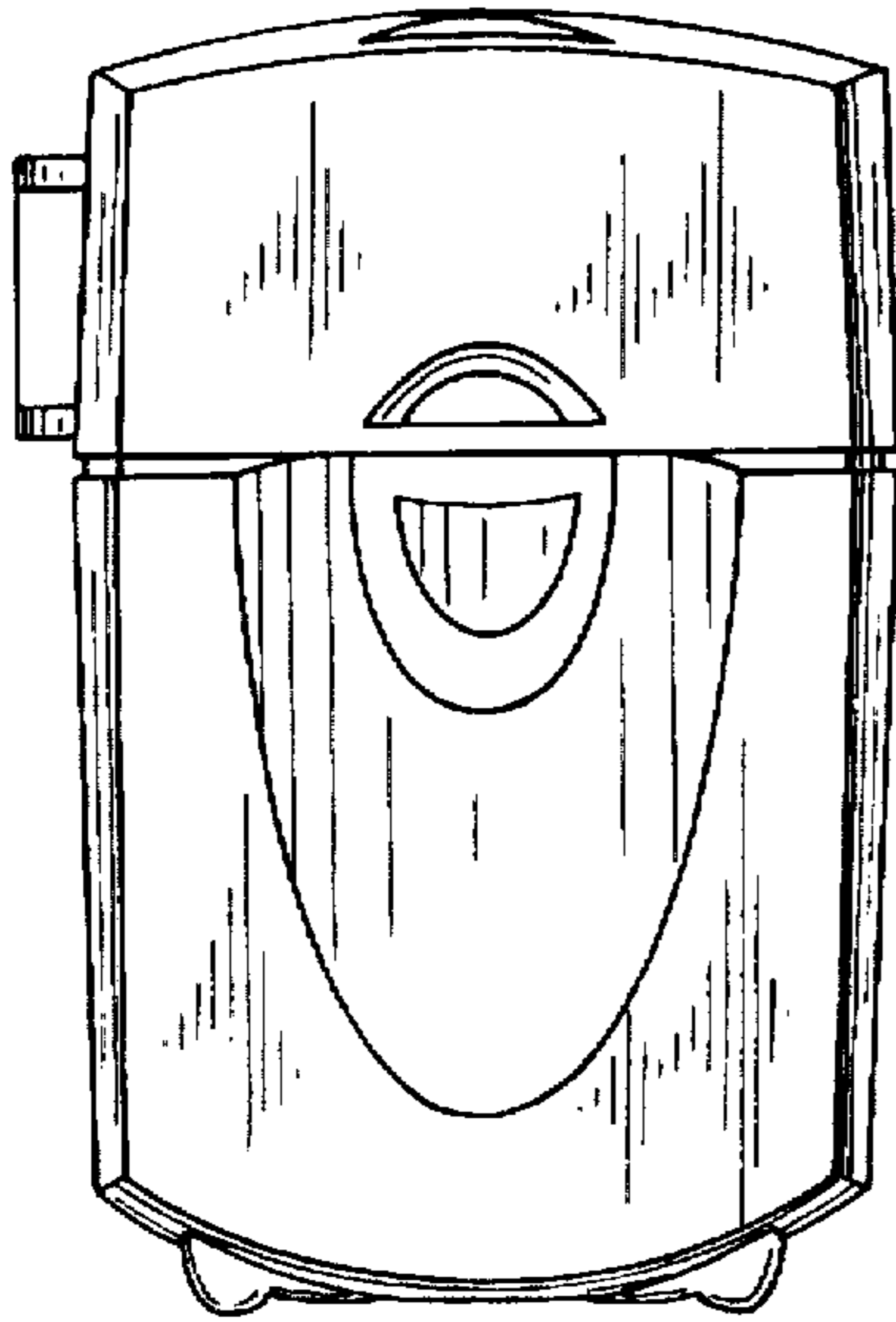

FIG. 2

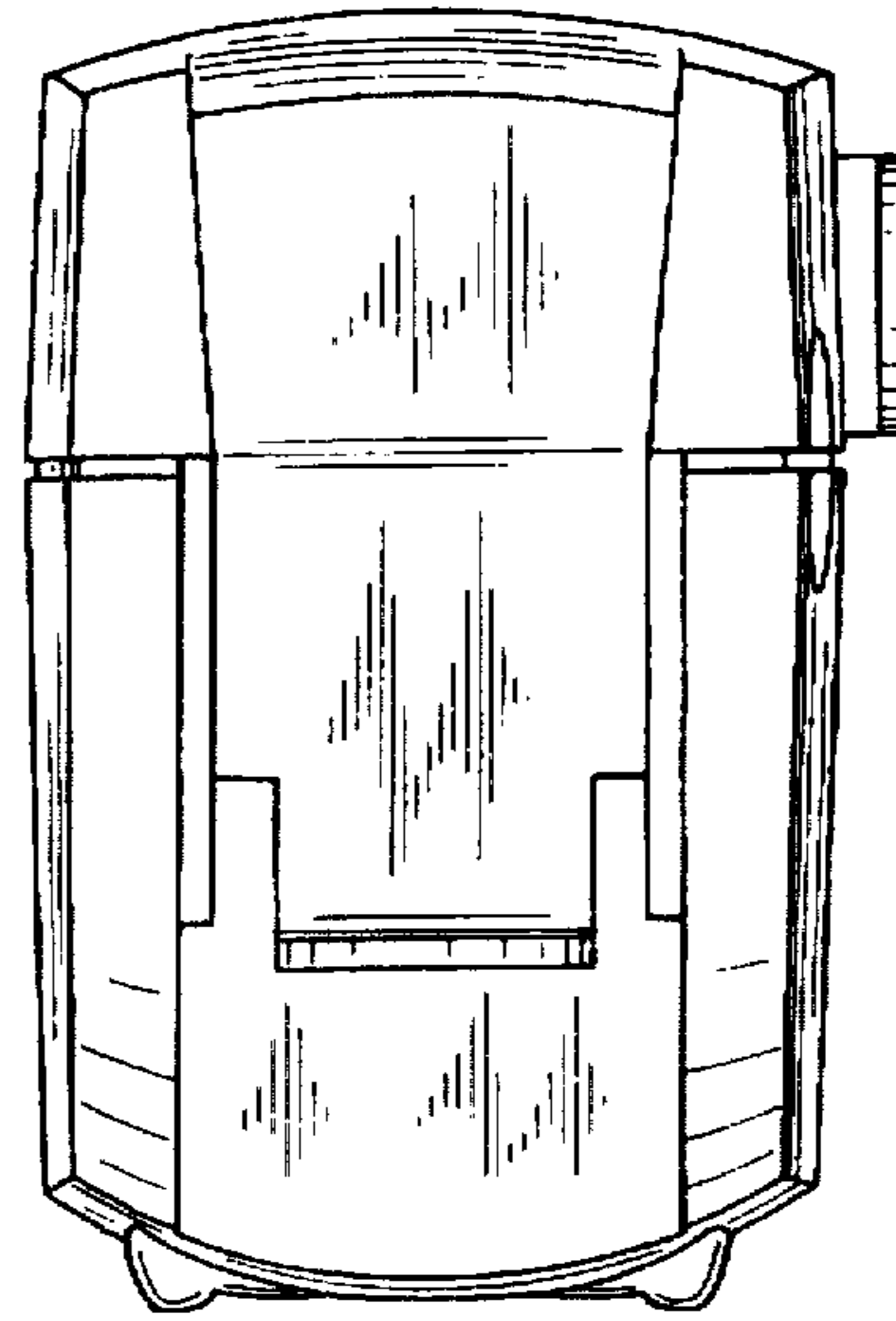

FIG. 3

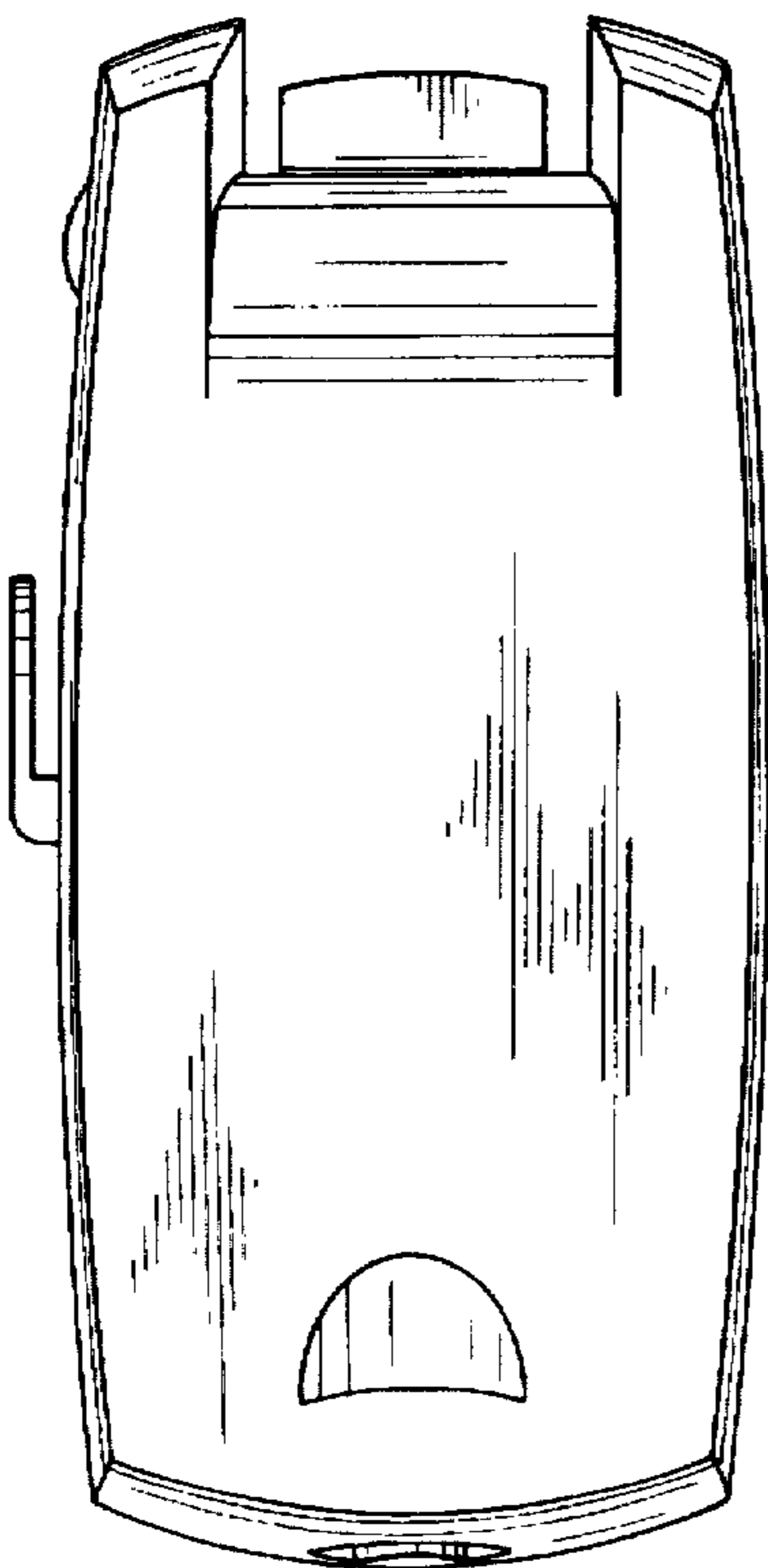

FIG. 4

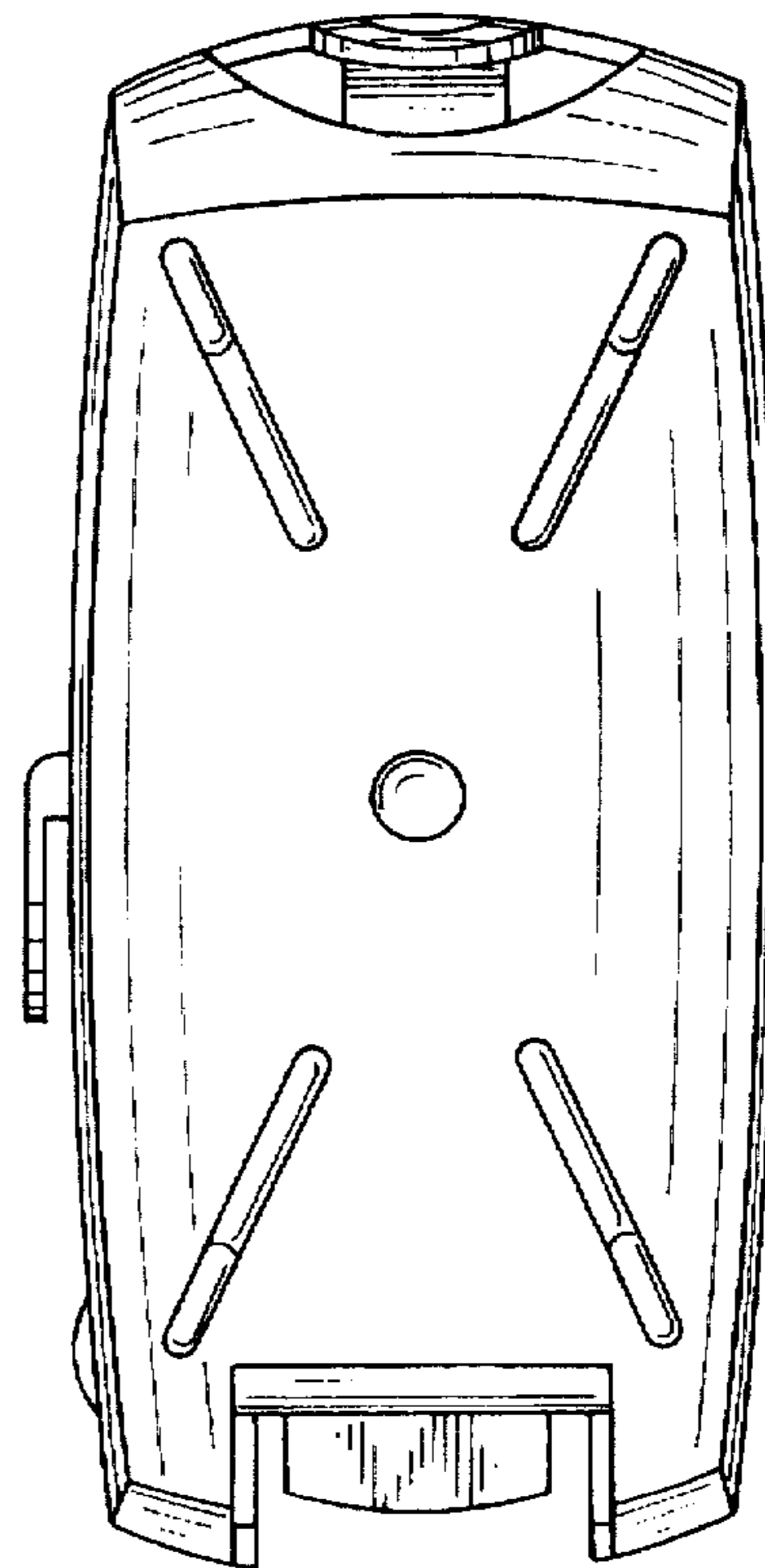

FIG. 5

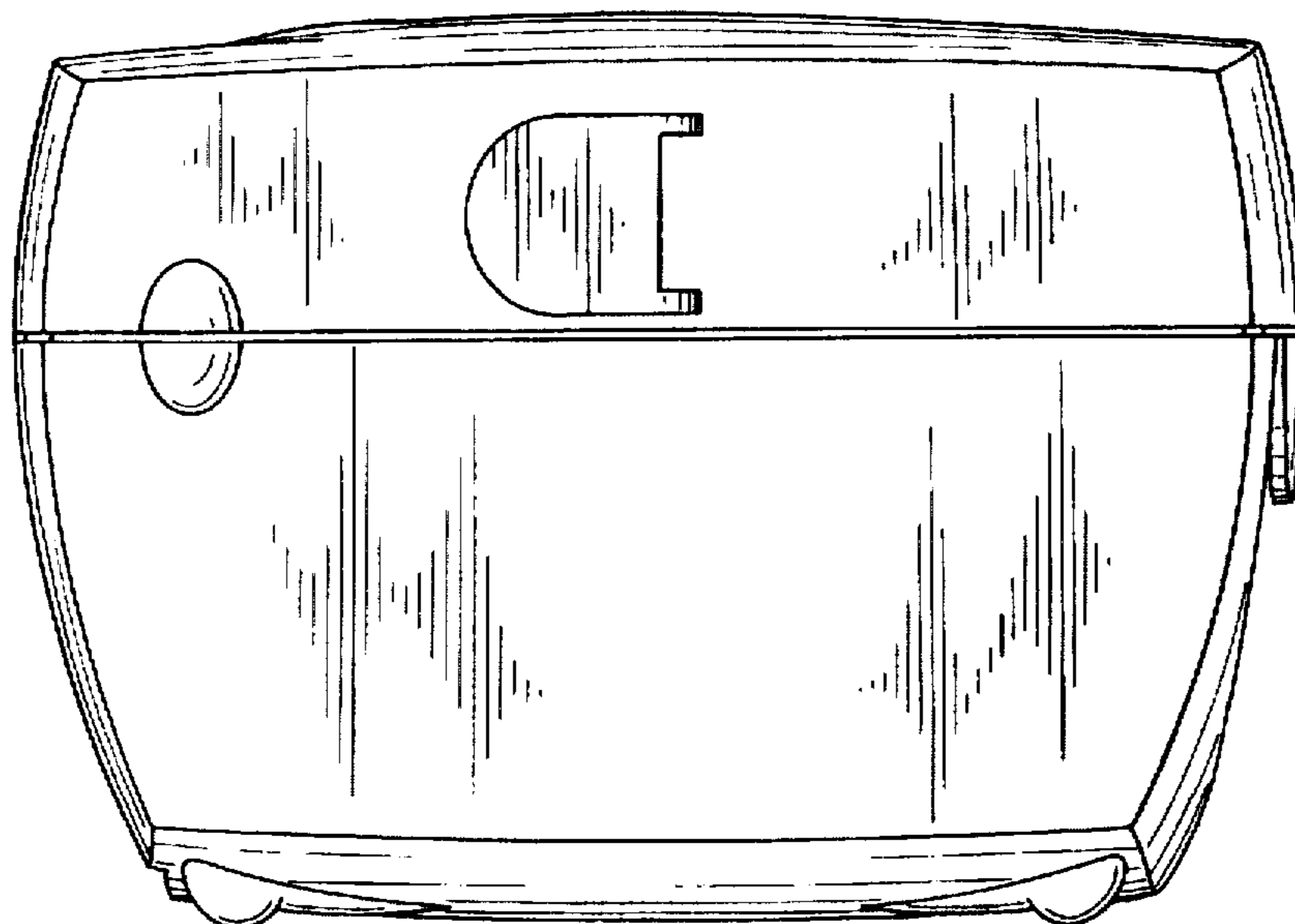

FIG. 6

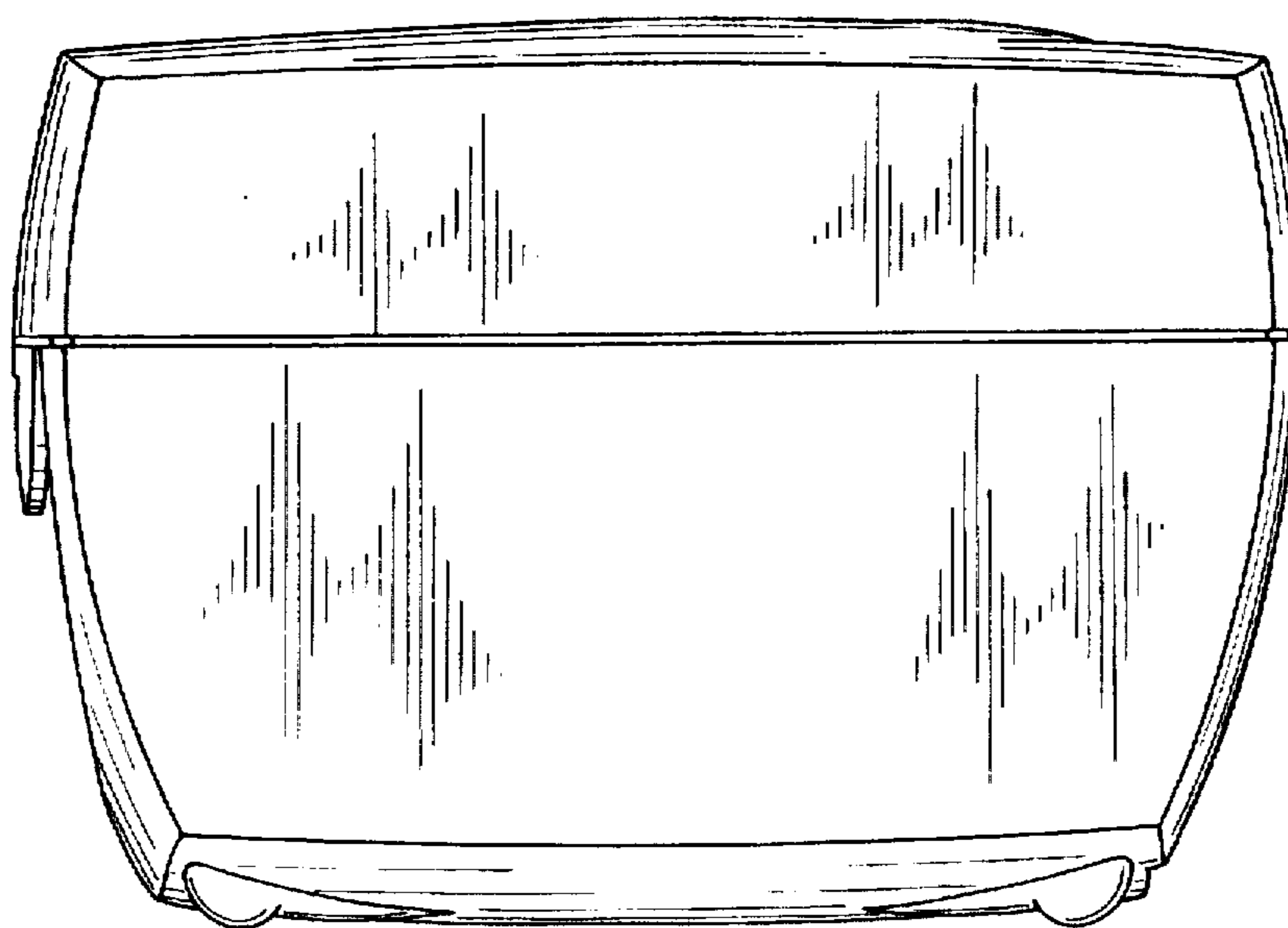

FIG. 7

