



US00D397202S

United States Patent [19]
Saar

[11] **Patent Number: Des. 397,202**

[45] **Date of Patent: **Aug. 18, 1998**

[54] **AIR CONDITIONER DUCT**

[76] **Inventor: Keith Clyde Saar, 295 Burson St.,
Williston, S.C. 29853**

[**] **Term: 14 Years**

[21] **Appl. No.: 76,964**

[22] **Filed: Sep. 23, 1997**

[51] **LOC (6) Cl. 23-04**

[52] **U.S. Cl. D23/393; D23/387**

[58] **Field of Search D23/386, 387,
D23/393, 354, 261-263, 266, 267; 285/424,
131.1, 132.1, 125.1**

[56] **References Cited**

U.S. PATENT DOCUMENTS

1,066,329 7/1913 Schwedler 285/131.1

OTHER PUBLICATIONS

A delta Manufacturing Co. Inc. Cat., p. 14, #913 Y-Branch
Furnace Pipe Fitting, lower middle side of page.

Primary Examiner—Lisa Lichtenstein

Attorney, Agent, or Firm—Robert N. Schwartz, P.A.; Loren
D. Pearson; Robert M. Schwartz

[57] **CLAIM**

The ornamental design for an air conditioner duct, as shown.

DESCRIPTION

FIG. 1 is a top view of the air conditioner duct of the present
invention;

FIG. 2 is a front view of the air conditioner duct;

FIG. 3 is a bottom view of the front view of the air
conditioner duct;

FIG. 4 is a left side view of the air conditioner duct;

FIG. 5 is a rear view of the air conditioner duct;

FIG. 6 is a right side view of the air conditioner duct; and,

FIG. 7 is a perspective view of the air conditioner duct.

1 Claim, 3 Drawing Sheets

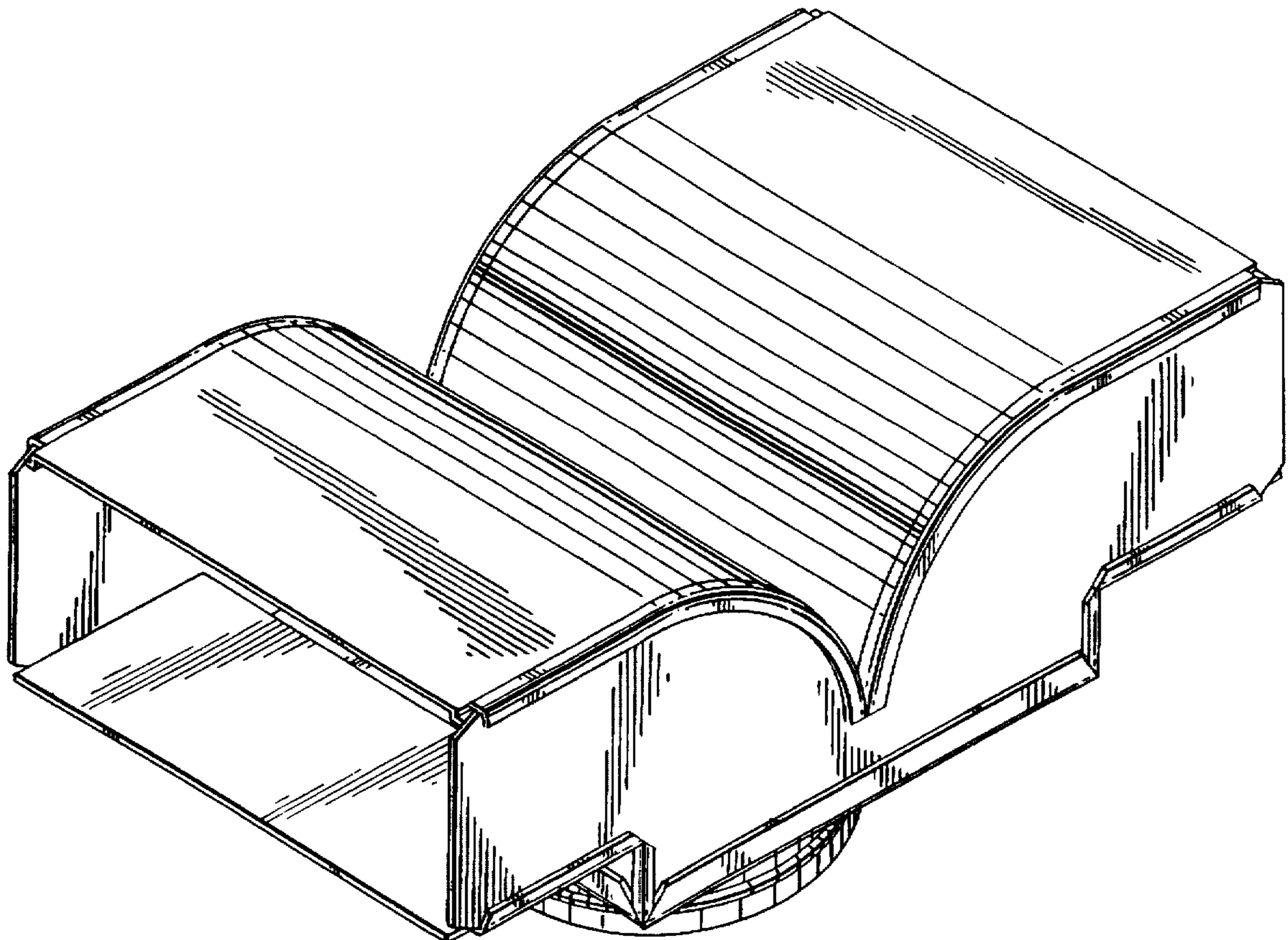

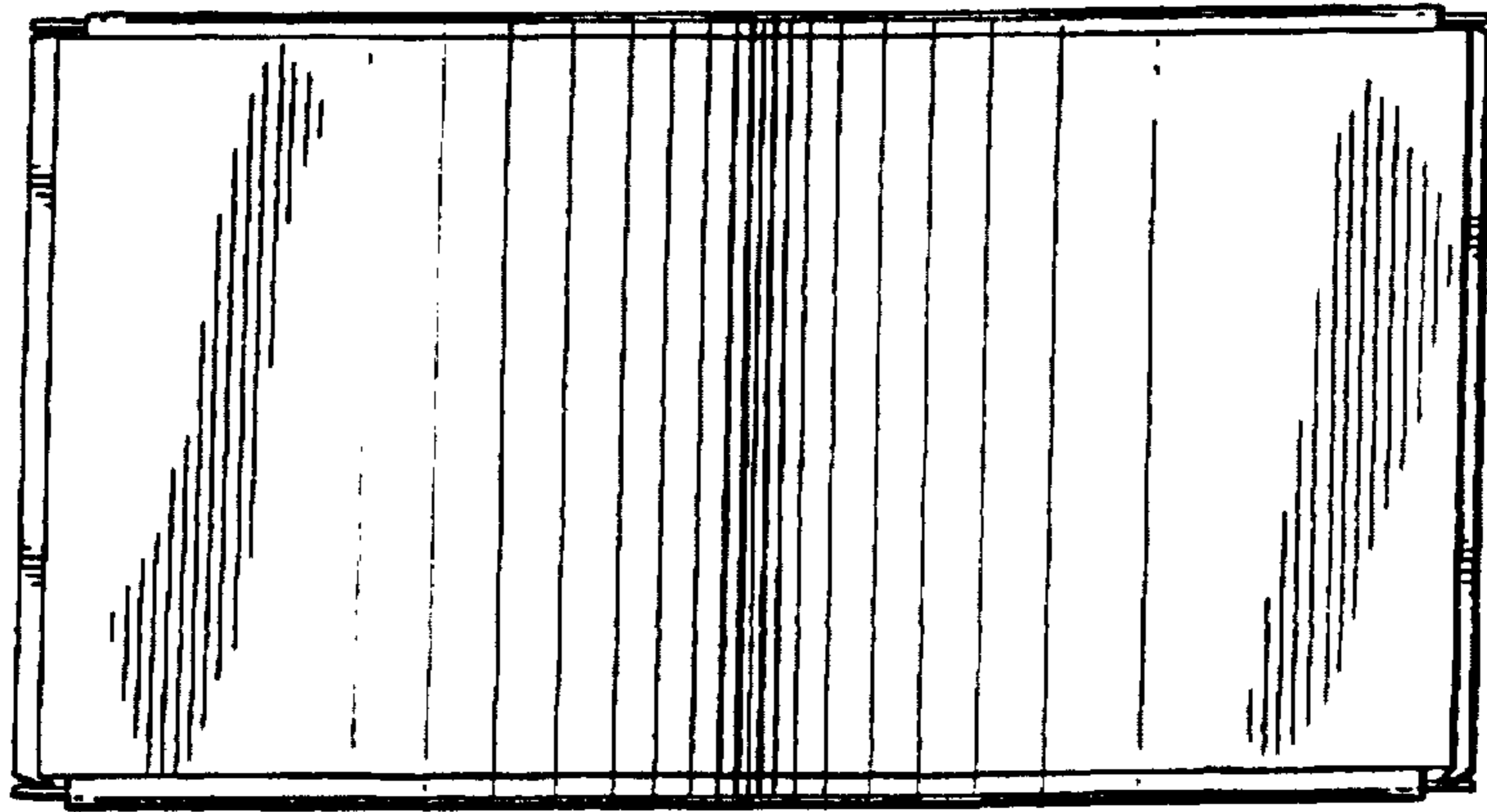

FIG. 1.

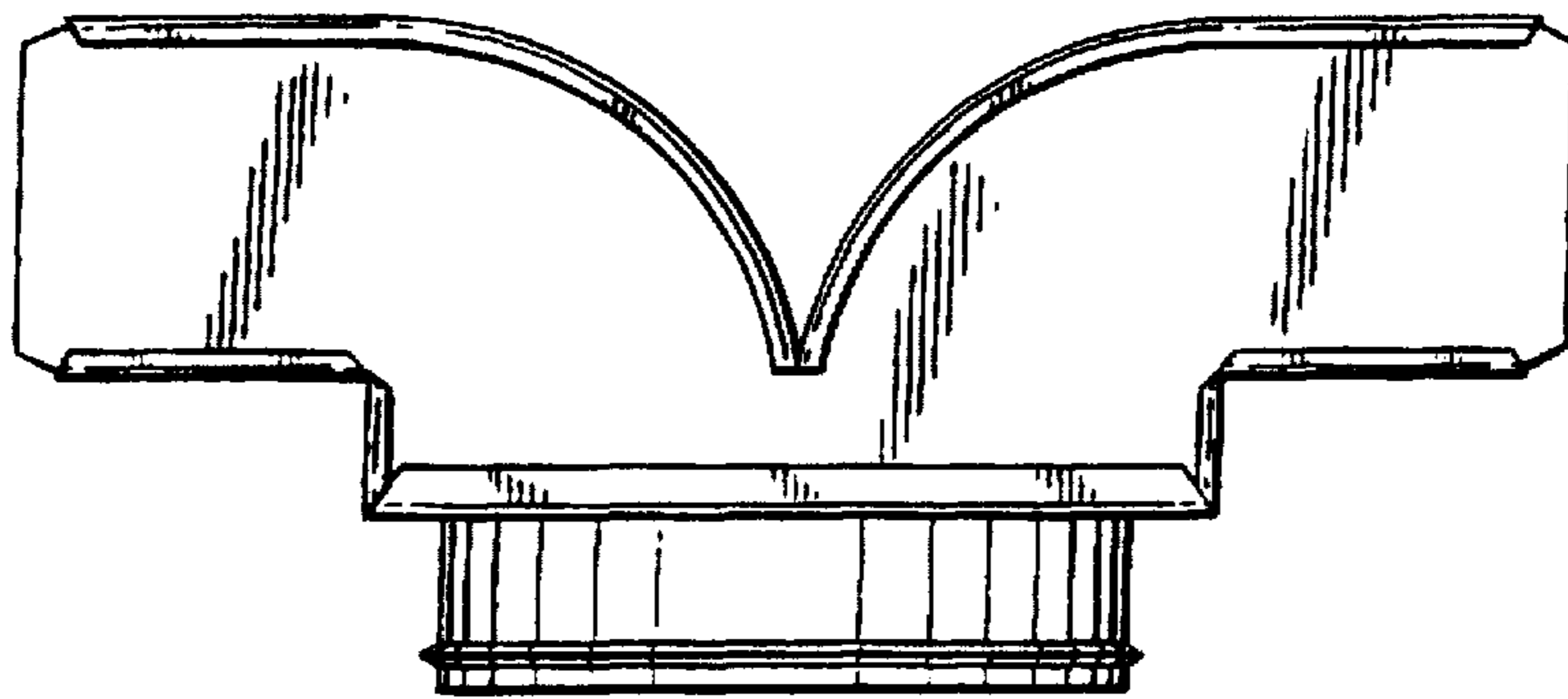

FIG. 2.

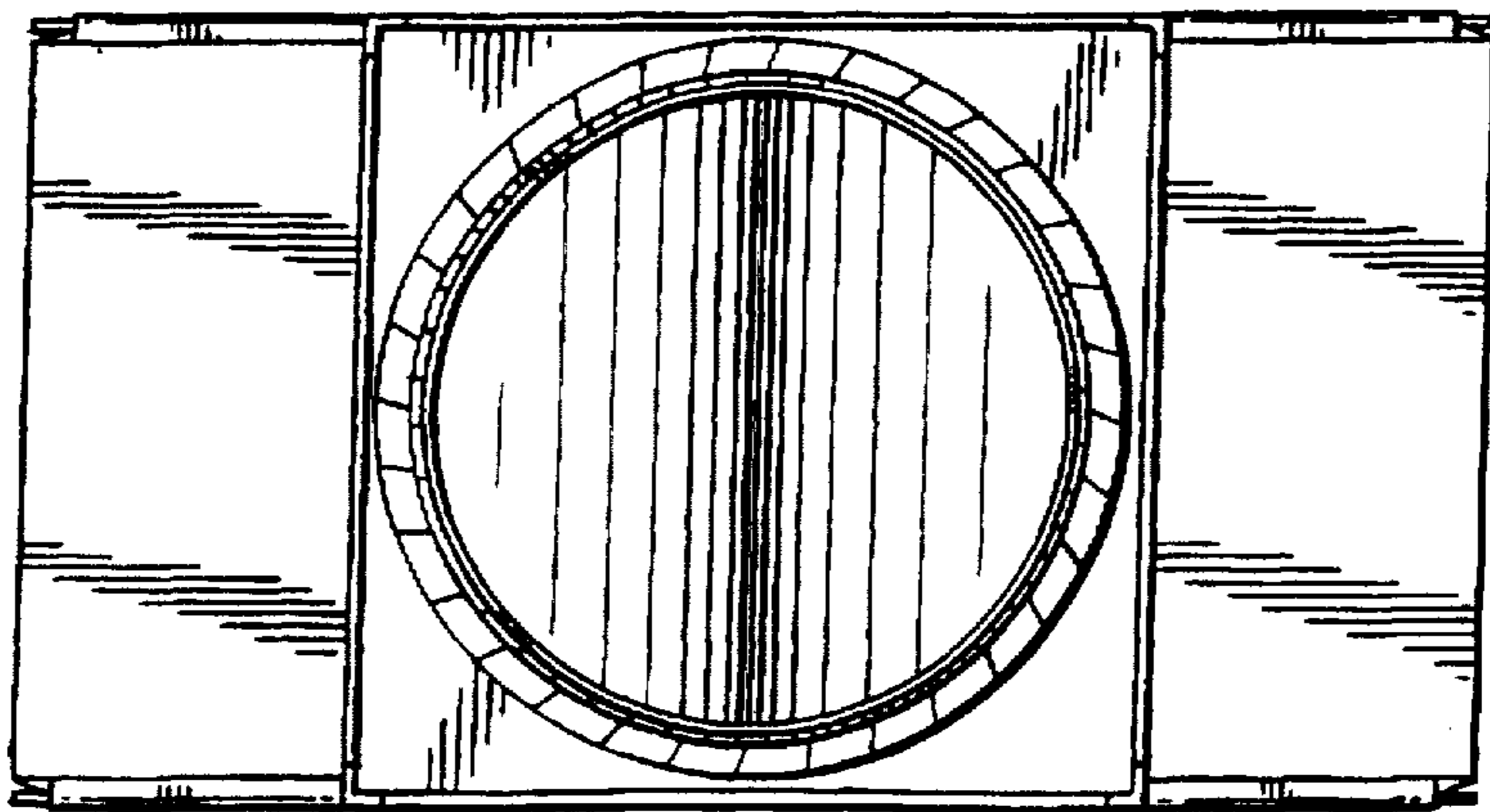

FIG. 3.

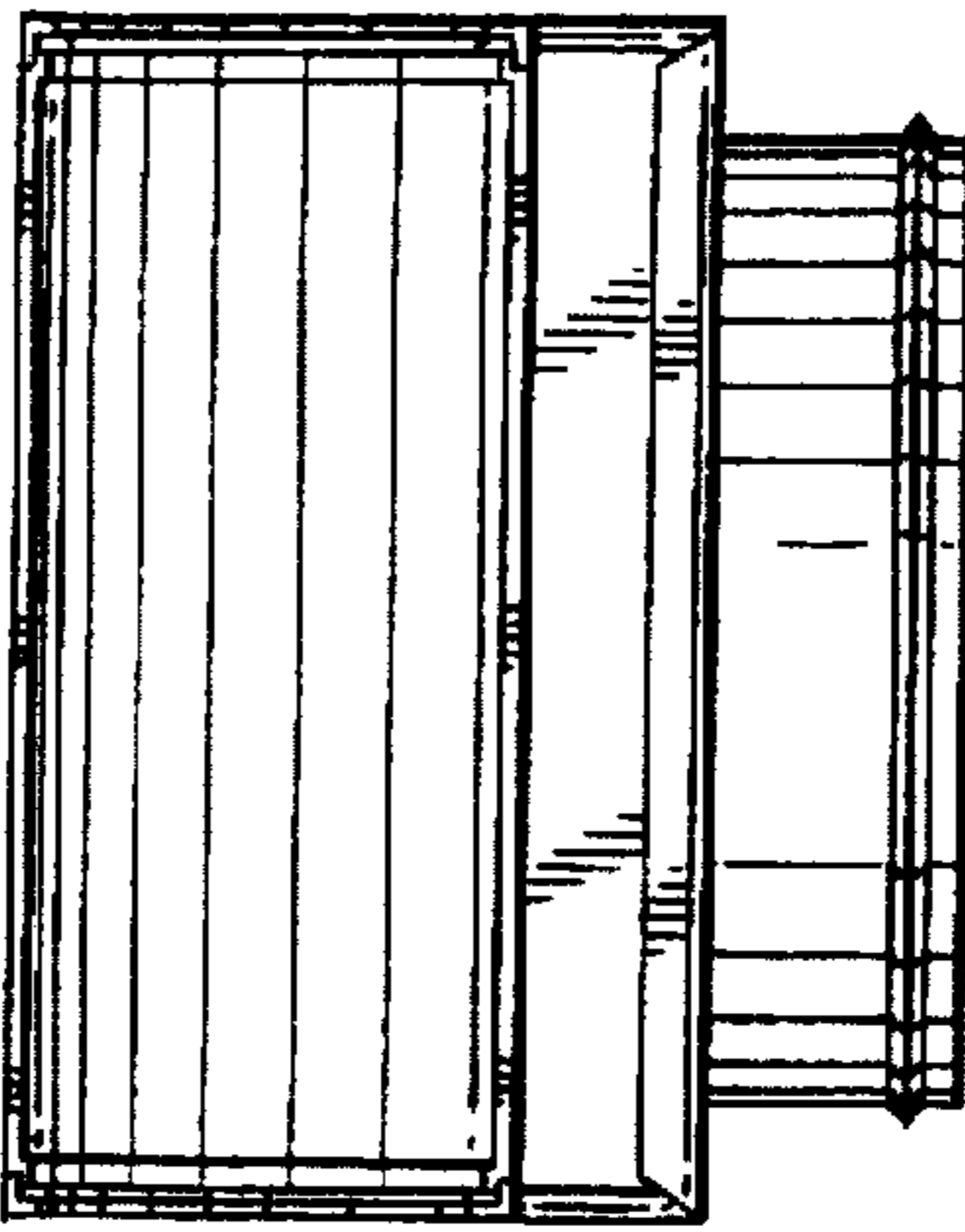

FIG. 6.

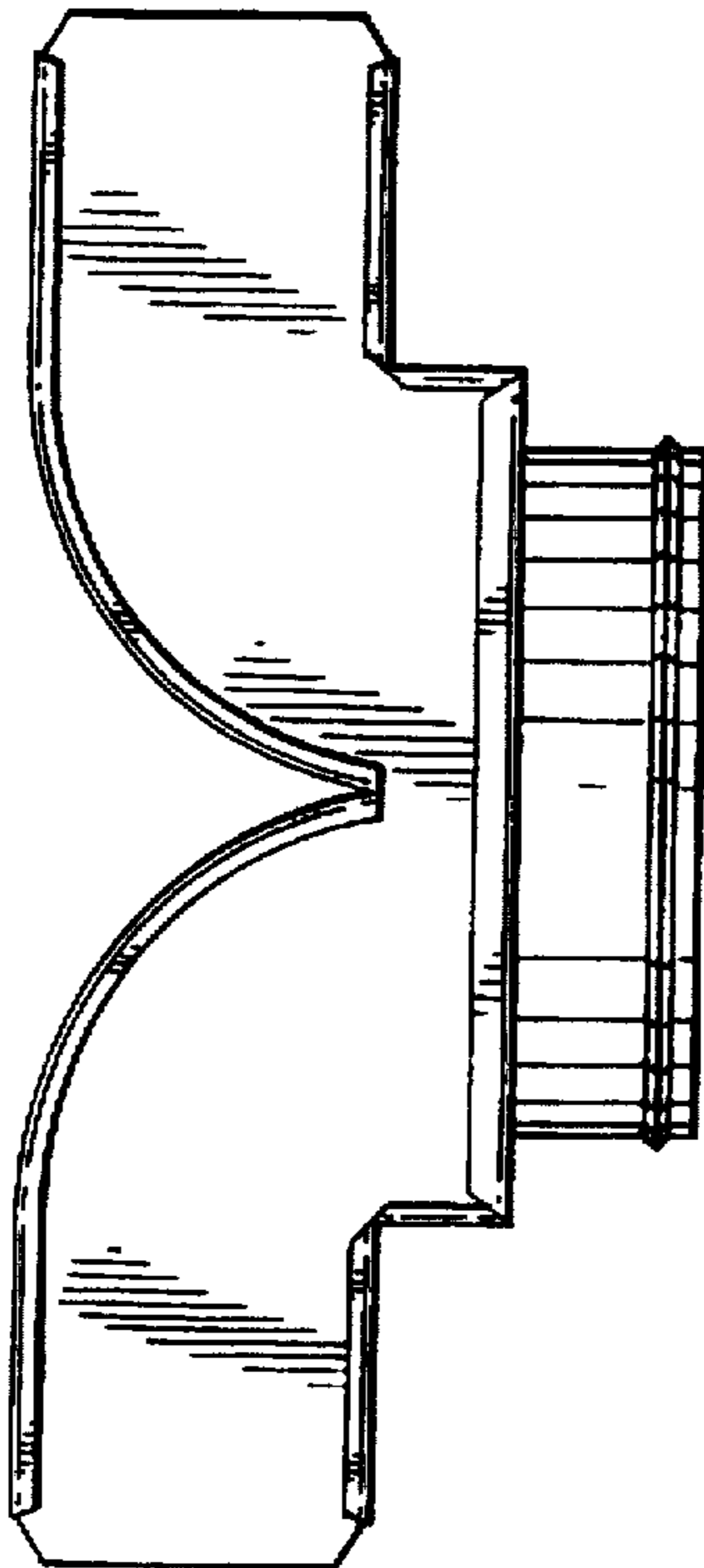

FIG. 5.

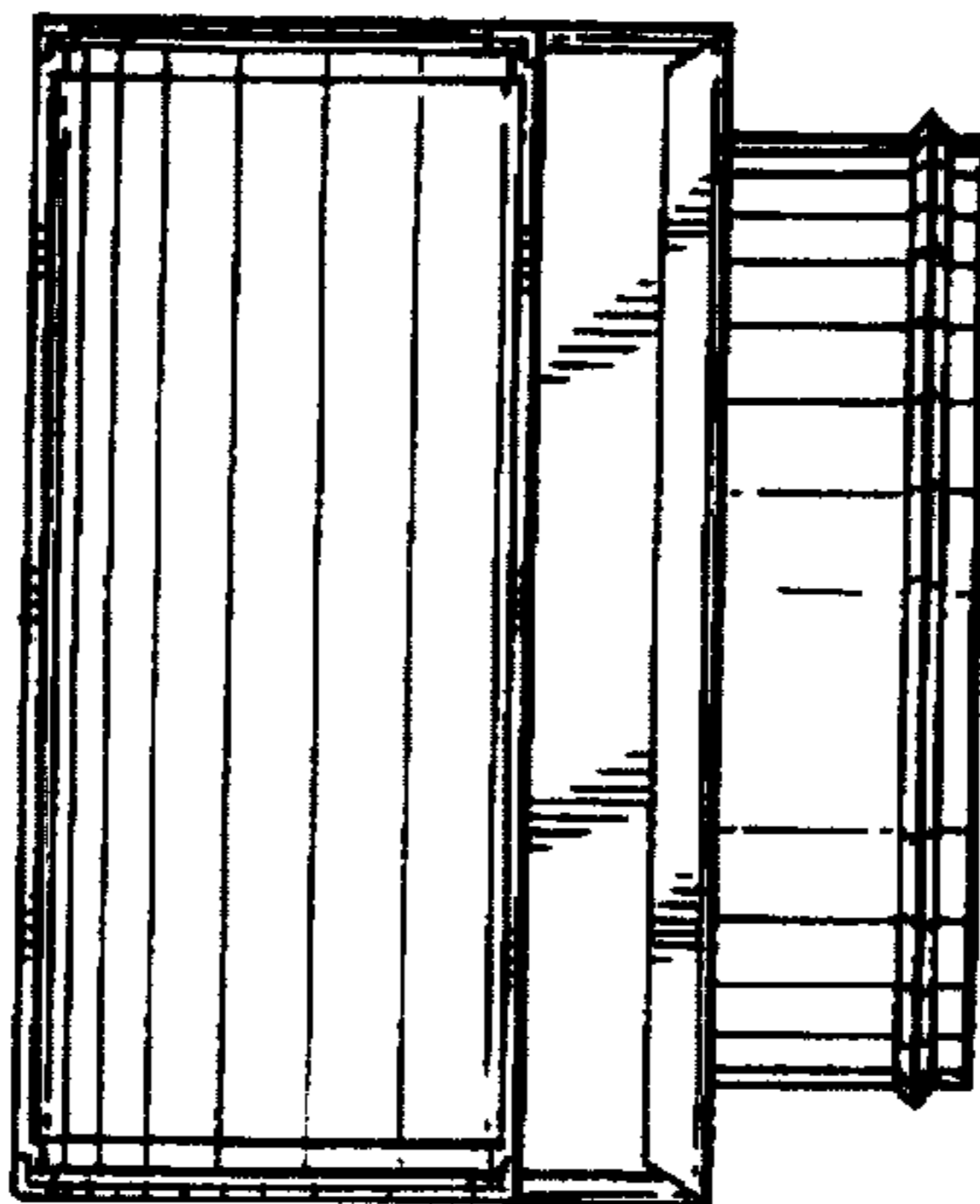
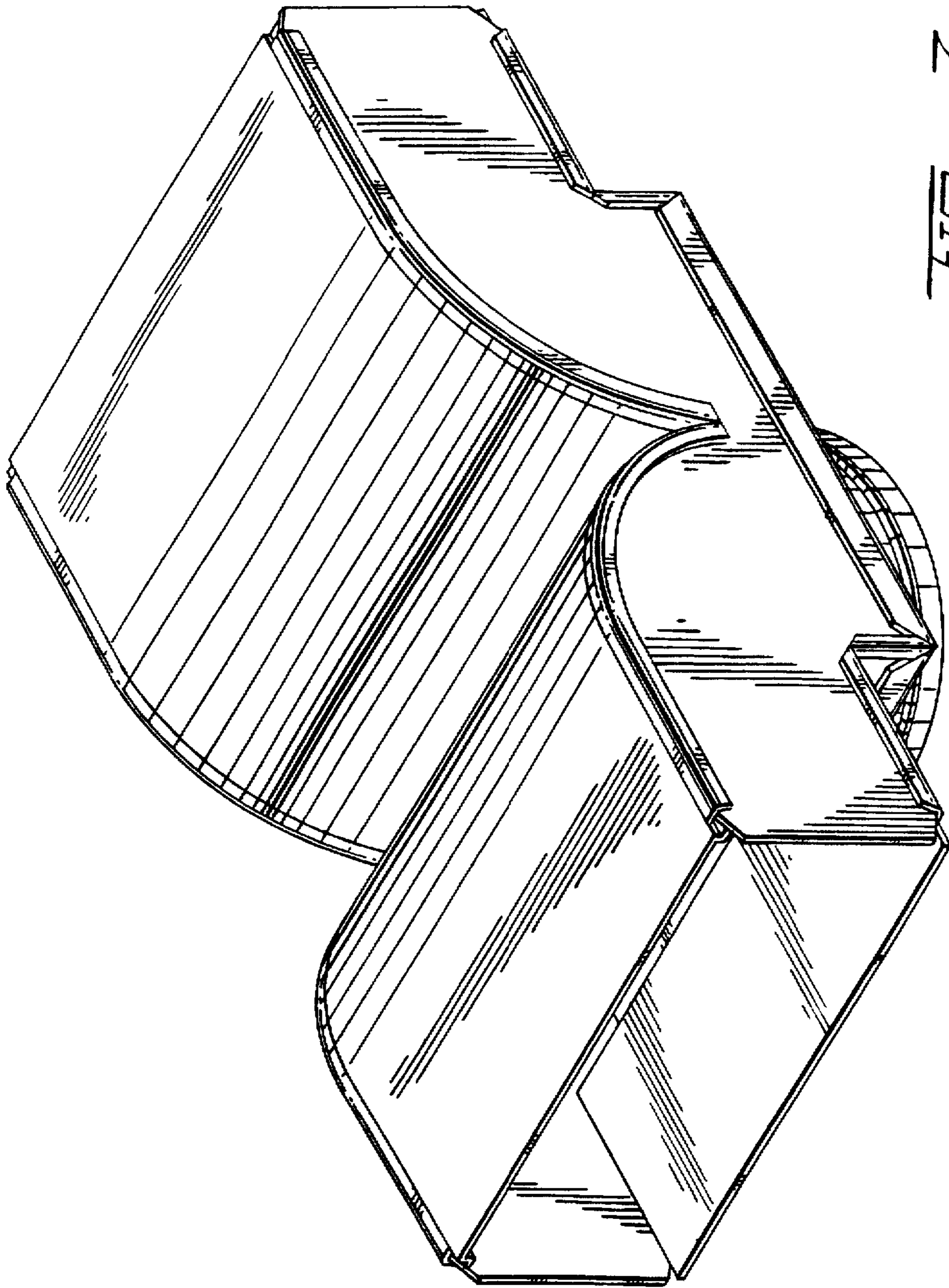

FIG. 4.



- 2 -
FIG