



US00D397004S

United States Patent [19]

McMaster et al.

[11] Patent Number: **Des. 397,004**

[45] Date of Patent: ****Aug. 18, 1998**

[54] **GARDEN SHOVEL**

[76] Inventors: **James W. McMaster; Susan J. McMaster**, both of 8873 Alabama St., Riverside, Calif. 92503

[**] Term: **14 Years**

[21] Appl. No.: **74,490**

[22] Filed: **Jul. 31, 1997**

[51] LOC (6) Cl. **08-01**

[52] U.S. Cl. **D8/10**

[58] Field of Search D8/10; D19/77; 294/49, 50.5, 54.5, 55; D7/691

[56] **References Cited**

U.S. PATENT DOCUMENTS

D. 30,292 2/1899 Seble D7/691
5,660,421 8/1997 Krenzler 294/55 X

Primary Examiner—Holly Baynham

[57] **CLAIM**

The ornamental design for a garden shovel, as shown.

DESCRIPTION

FIG. 1 is a front plan view of the garden shovel of the present invention;

FIG. 2 is a back plan view of the garden shovel of FIG. 1; FIG. 3 is a left side plan view of the garden shovel of FIG. 1;

FIG. 4 is a right side plan view of the garden shovel of FIG. 1;

FIG. 5 is a top plan view of the garden shovel of FIG. 1;

FIG. 6 is a bottom plan view of the garden shovel of FIG. 1; and,

FIG. 7 is an exploded top, front, right side perspective view of the garden shovel of FIG. 1.

The claimed design is shown detached for clarity of illustration.

1 Claim, 3 Drawing Sheets

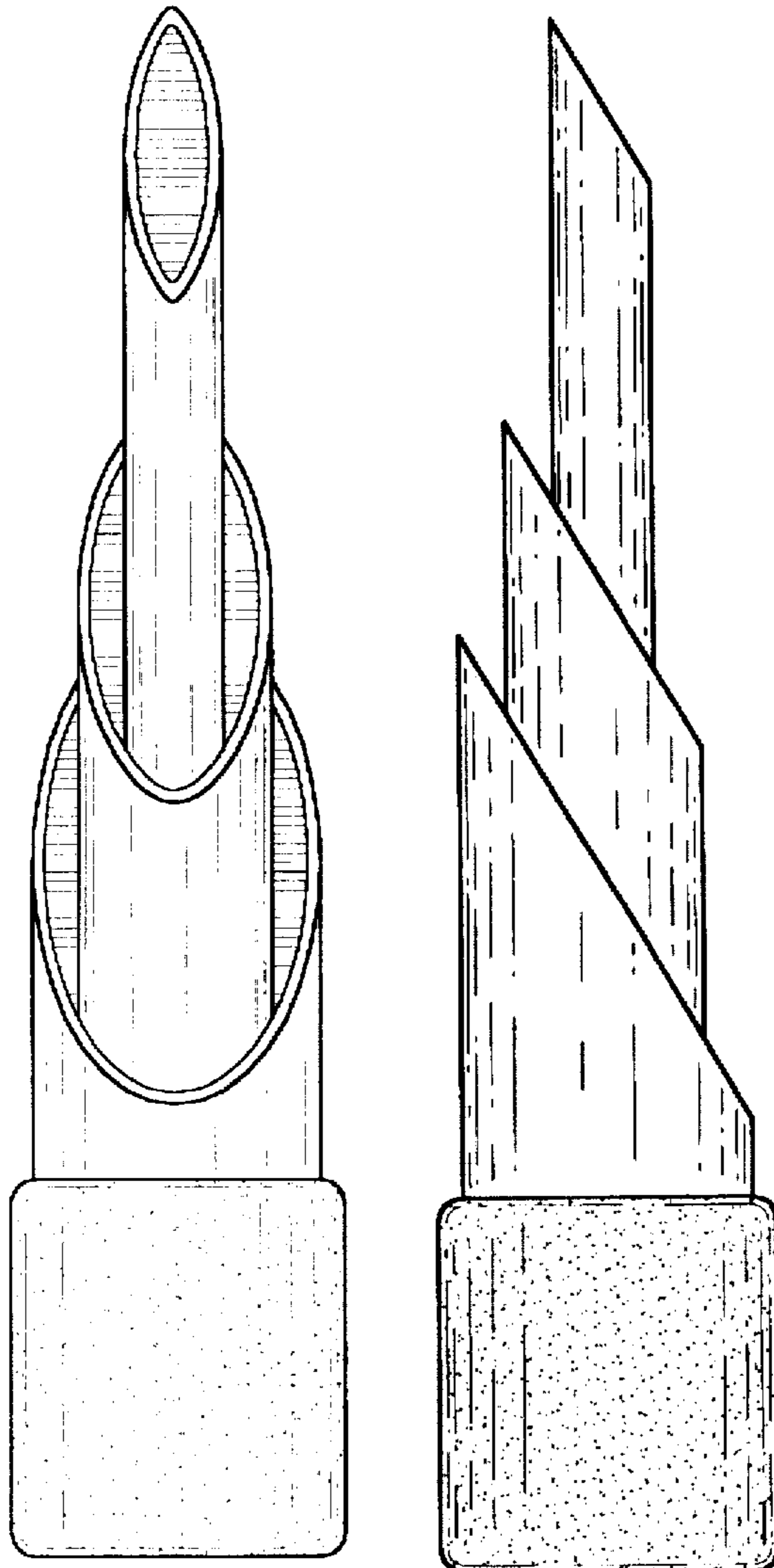

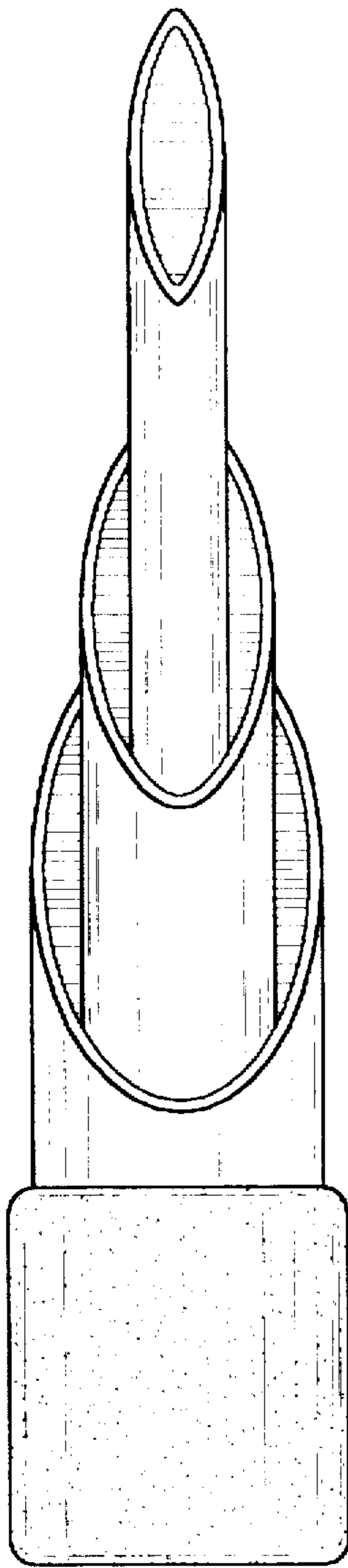

Fig. 1

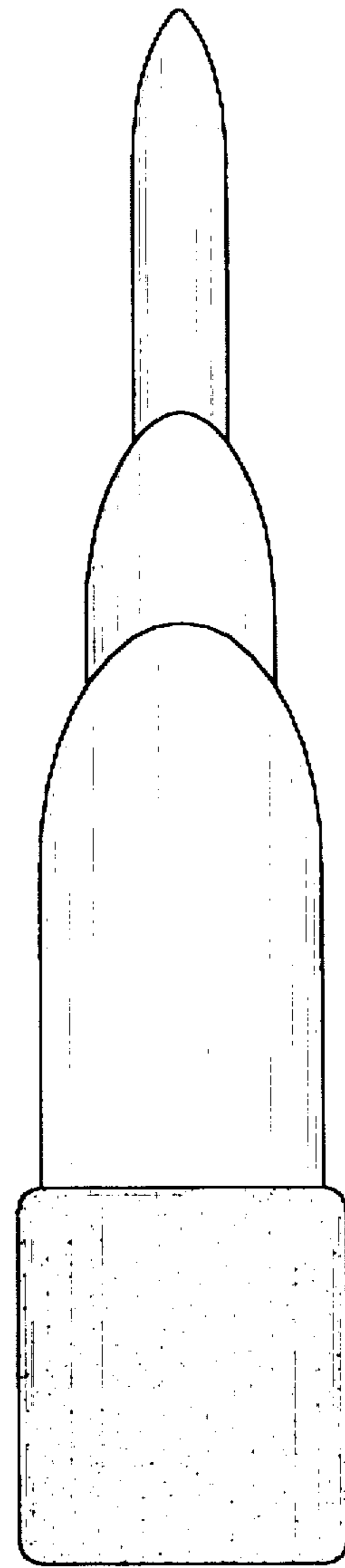

Fig. 2

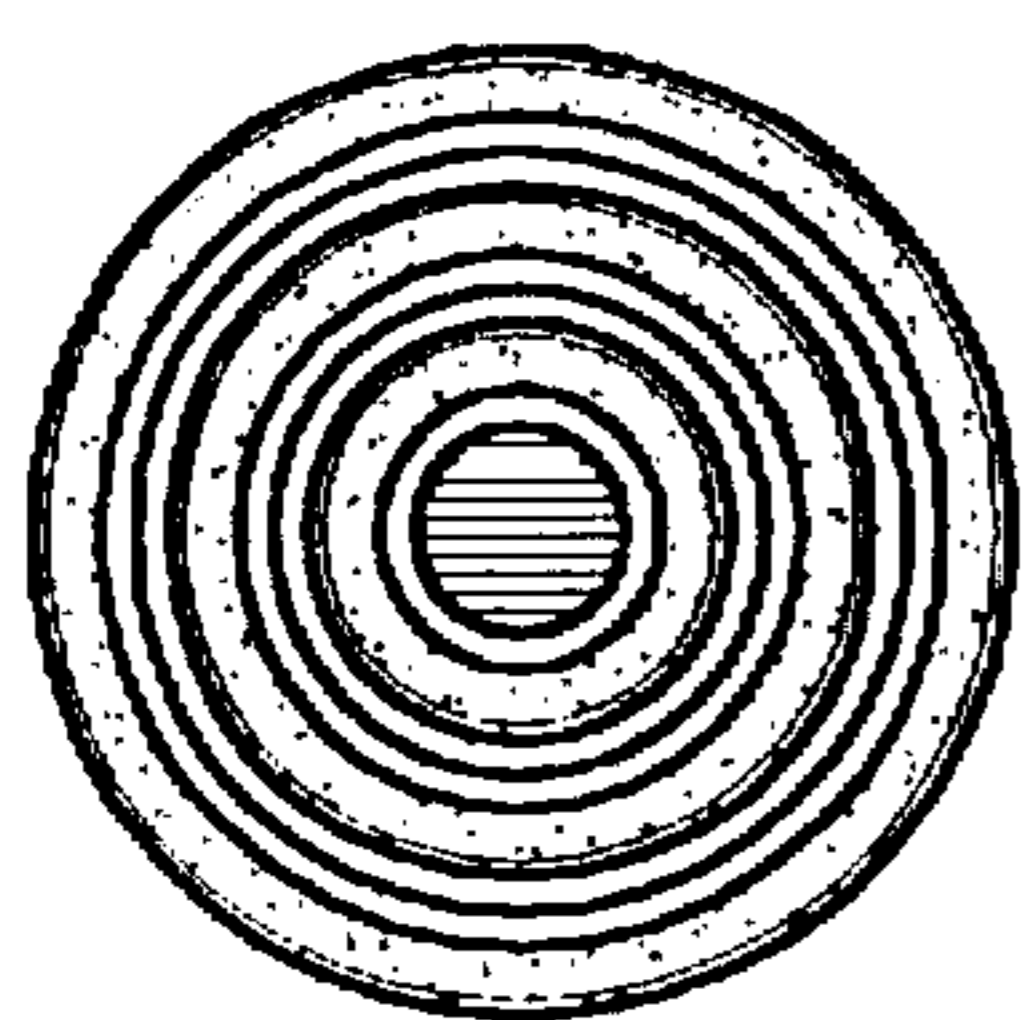

Fig. 5

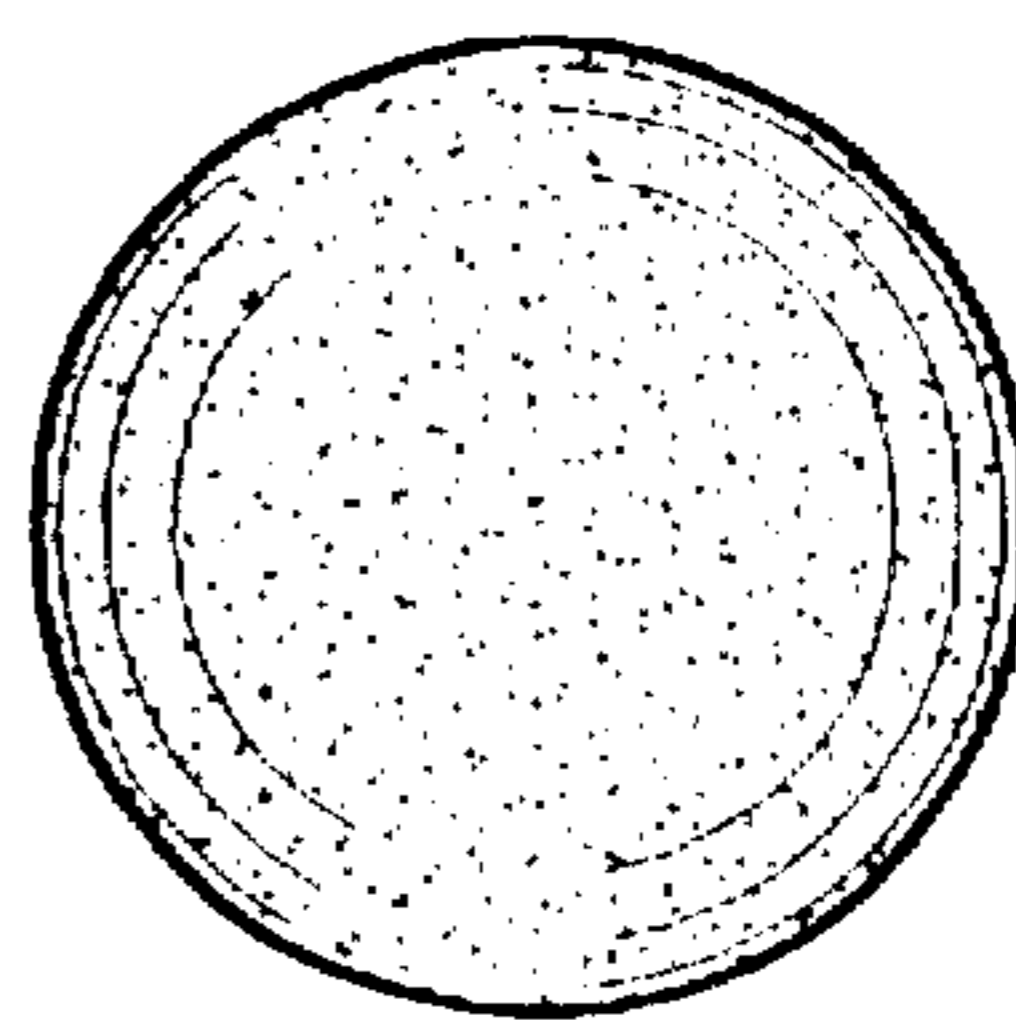

Fig. 6

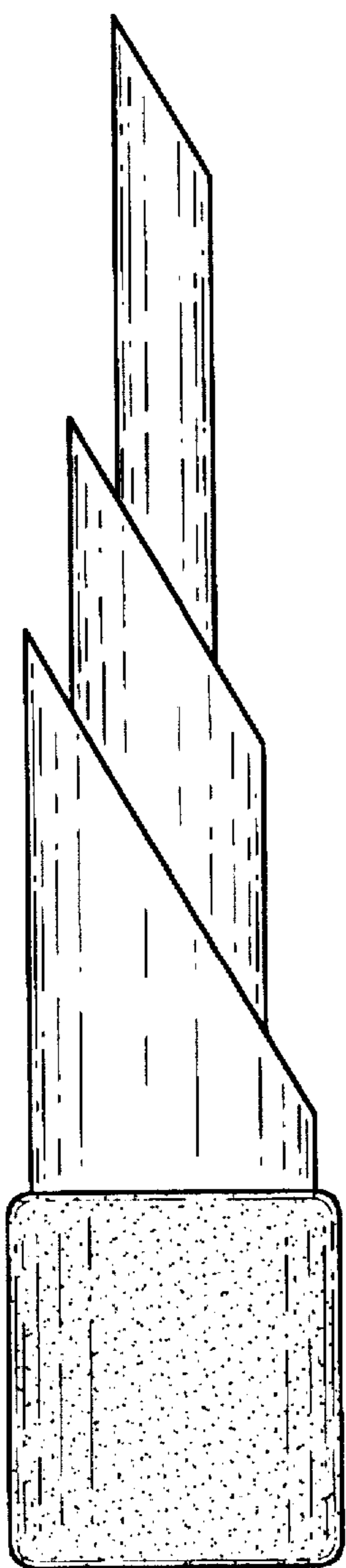

Fig. 3

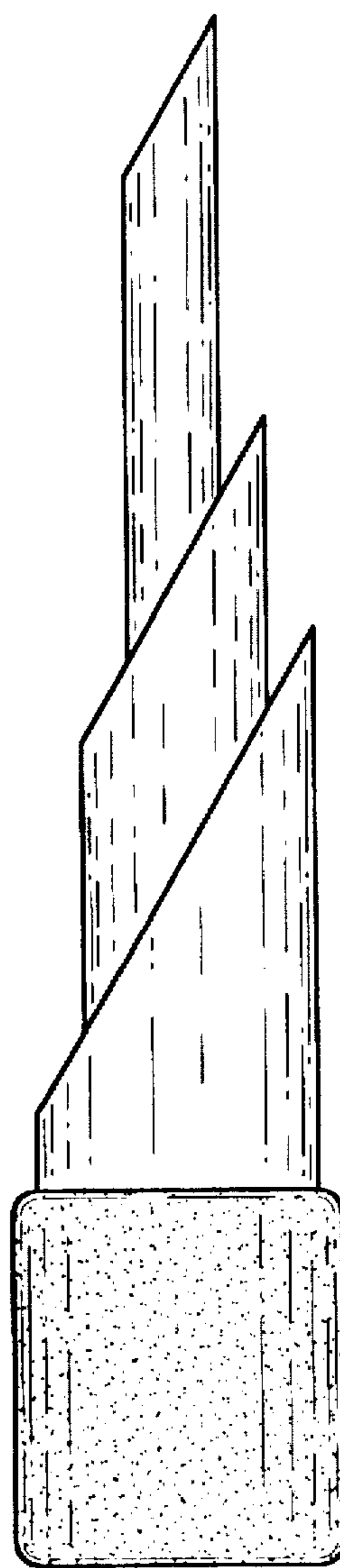

Fig. 4

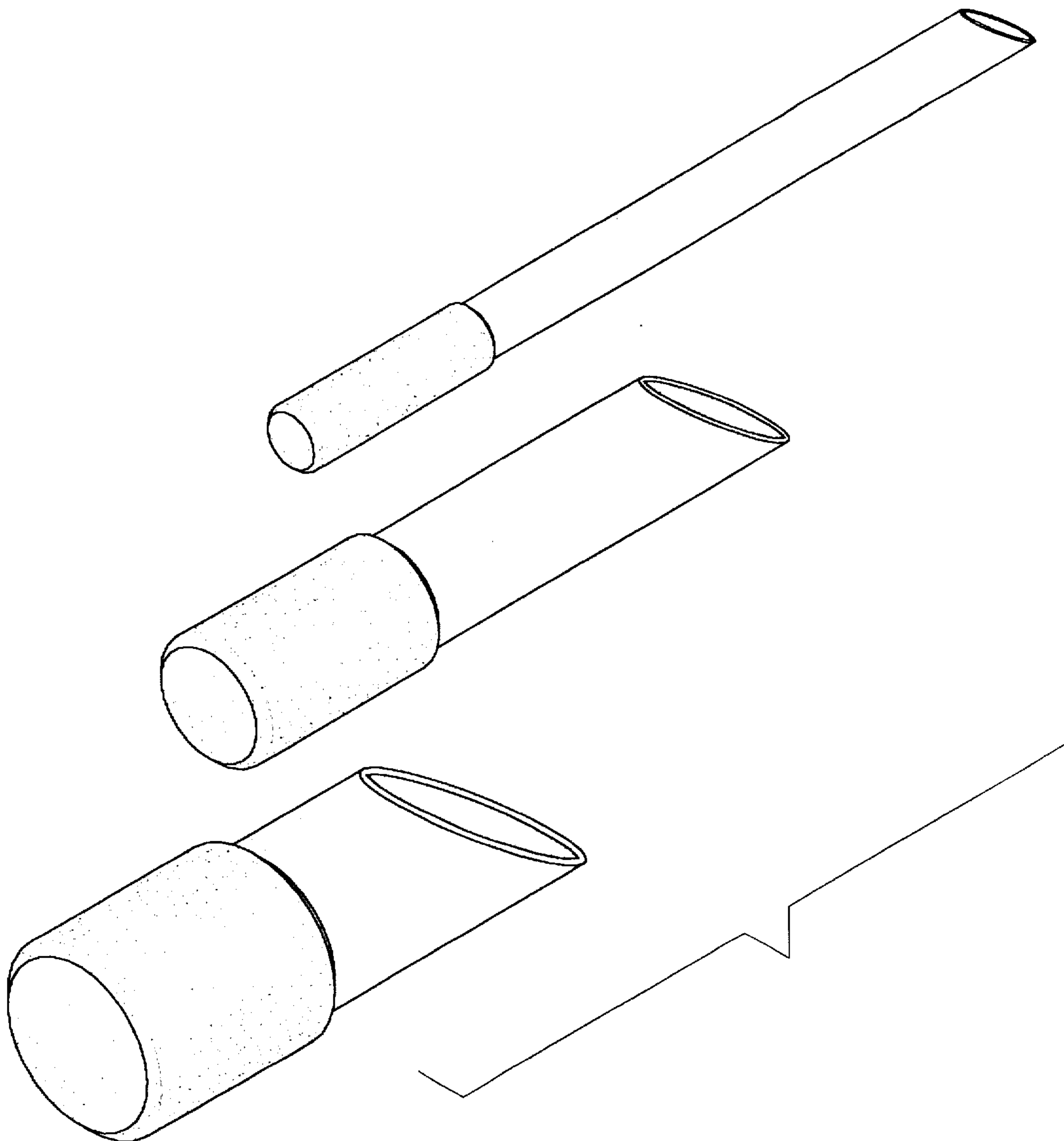

Fig. 7