



US00D396979S

United States Patent [19]

Lawrence

[11] Patent Number: **Des. 396,979**

[45] Date of Patent: ****Aug. 18, 1998**

[54] **WALL MOUNTED JEWELRY CASE**

4,739,886 4/1988 Seaberg 211/13.1
4,978,001 12/1990 Nelson 206/45.11

[76] Inventor: **Sandra K. Lawrence**, 1489 Golf Course Rd., West Jefferson, N.C. 28694

Primary Examiner—Pamela Burgess

[**] Term: **14 Years**

[57] CLAIM

[21] Appl. No.: **73,925**

The ornamental design for a wall mounted jewelry case, as shown and described.

[22] Filed: **Jul. 24, 1997**

DESCRIPTION

[51] **LOC (6) Cl.** **06-04**

[52] **U.S. Cl.** **D6/560**

[58] **Field of Search** D6/559-561, 567-571, D6/573, 574; 206/45.11, 45.14, 566; 211/86.01-87.01, 89, 13.01; 312/224, 226, 209

FIG. 1 is a front elevational view of a wall-mounted jewelry case showing my new design;

FIG. 2 is a bottom plan view thereof;

FIG. 3 is a top plan view thereof;

FIG. 4 is a rear elevational view thereof;

FIG. 5 is a right side elevation view thereof, the left side being a mirror image thereof;

FIG. 6 is a front perspective view thereof, in a first alternate opened position, with the door and inside panel opened; and,

FIG. 7 is a front perspective view thereof, in a second alternate opened position, with the door opened.

The cross-hatching shown in FIG. 6 indicates fabric which is understood to extend across the width of the surface.

[56] References Cited

U.S. PATENT DOCUMENTS

D. 237,234	10/1975	Wertz	D6/559
D. 243,490	3/1977	Reusink	D6/559
D. 251,166	2/1979	McIntosh	D6/560
D. 297,195	8/1988	Warwicker	D6/559
D. 329,565	9/1992	Kane et al.	D6/559
4,413,736	11/1983	Nibling	206/45.11 X
4,420,084	12/1983	Whelan	206/566

1 Claim, 3 Drawing Sheets

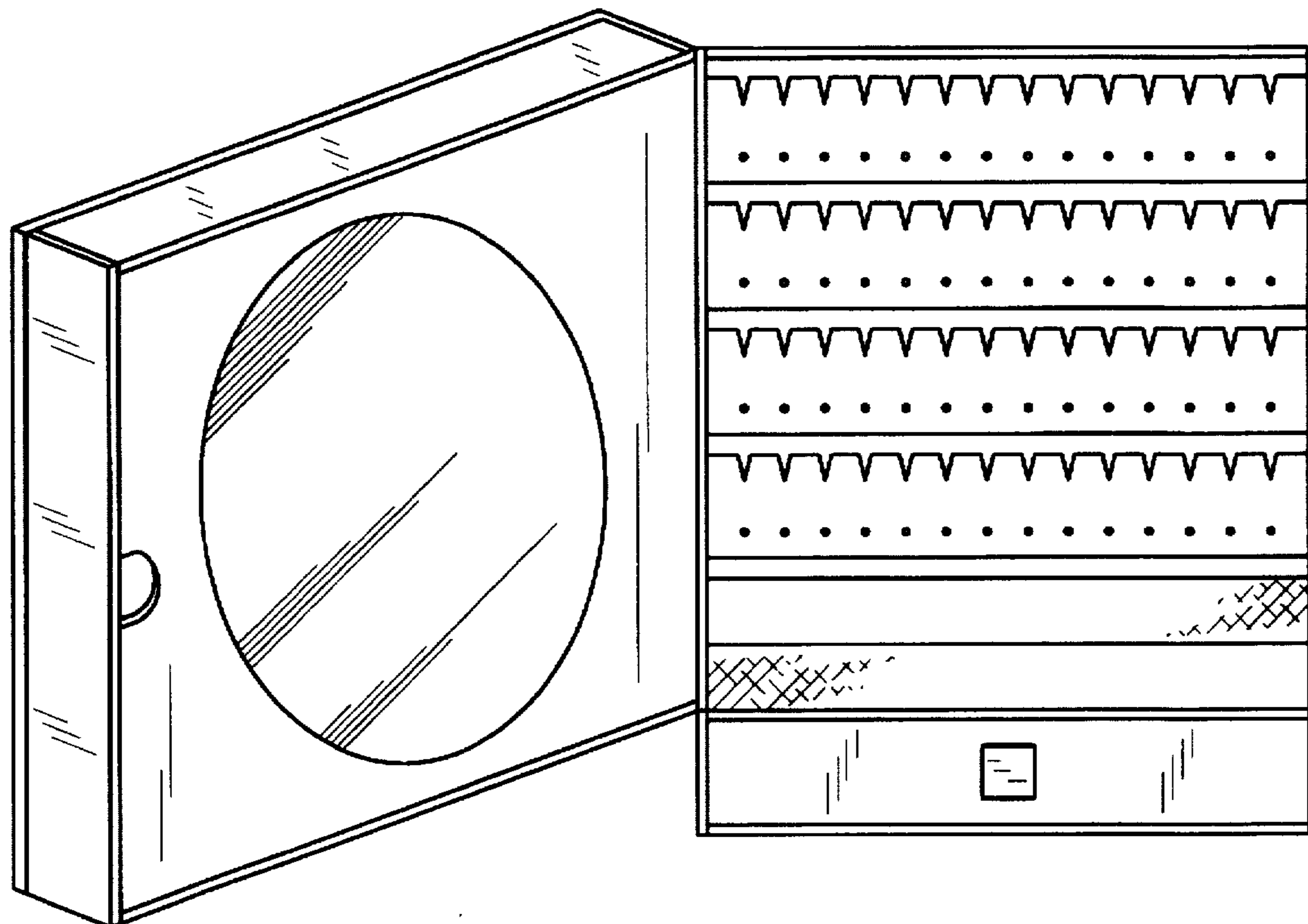

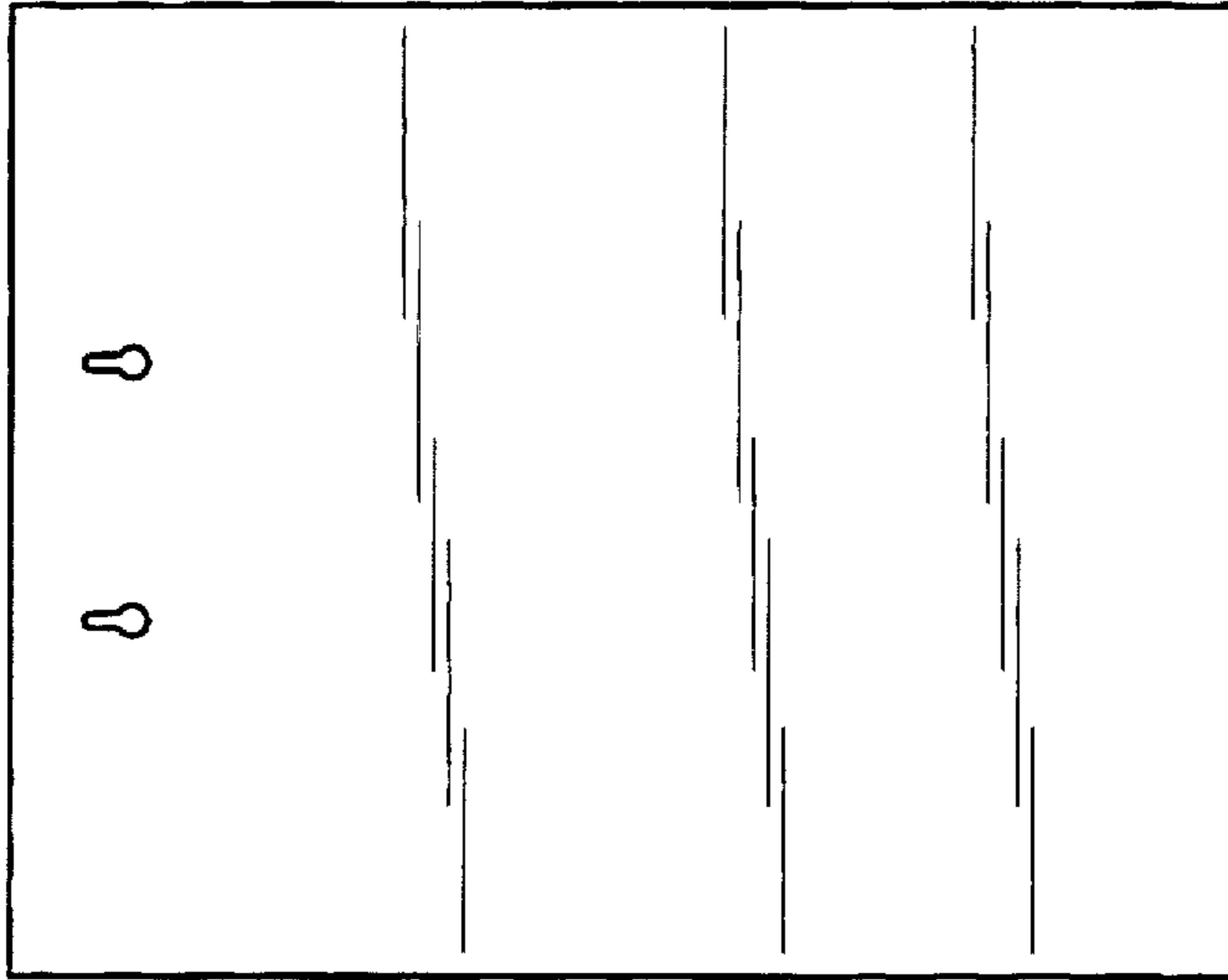

FIG. 4

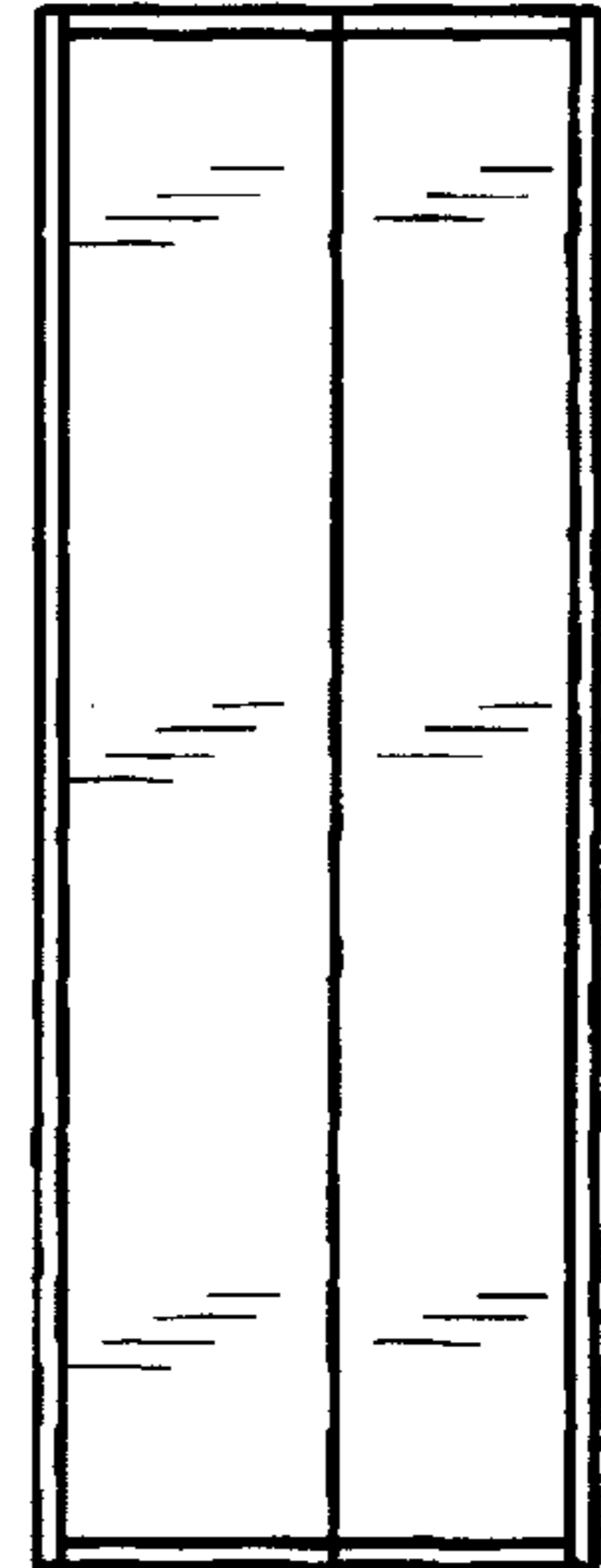

FIG. 3

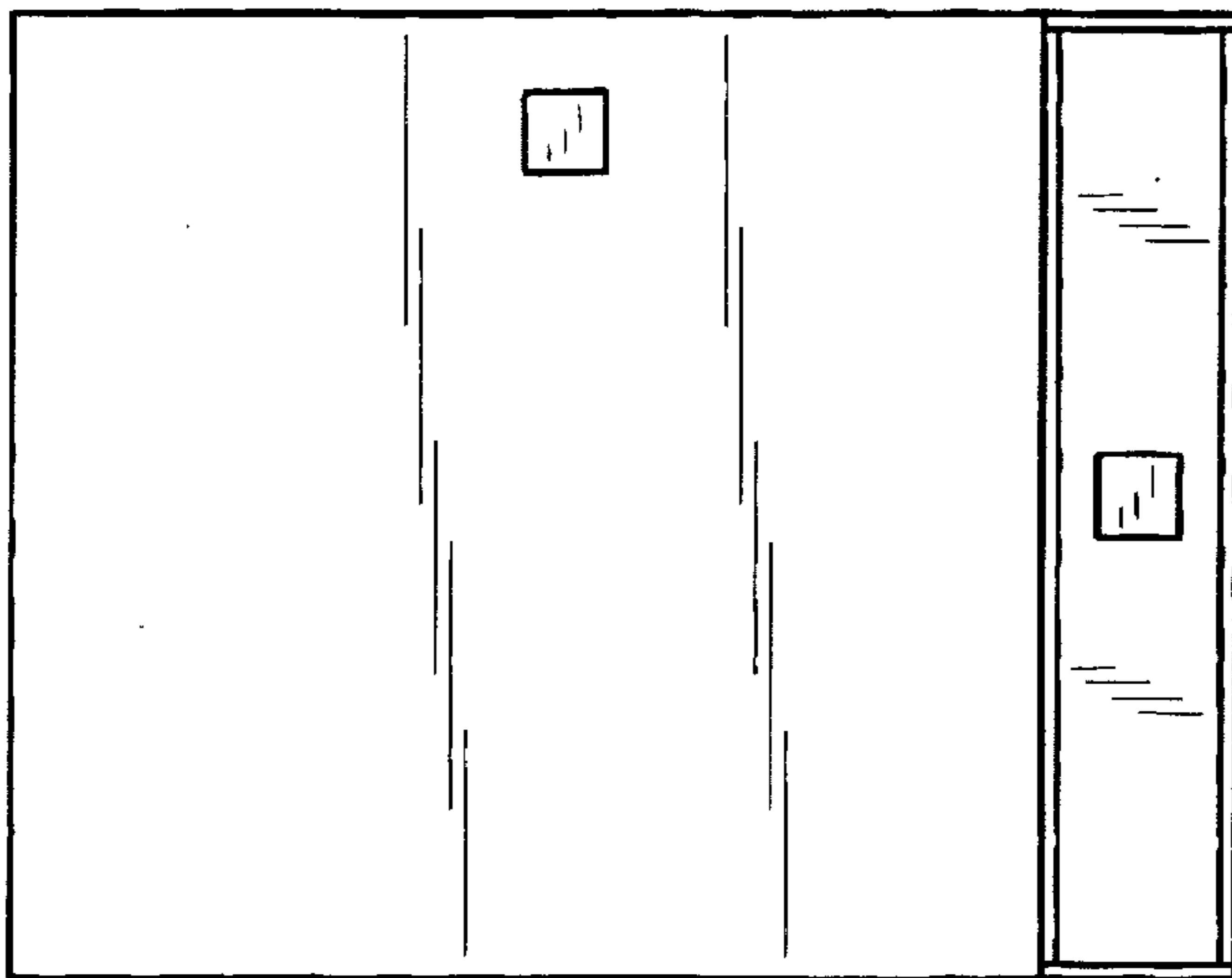

FIG. 1

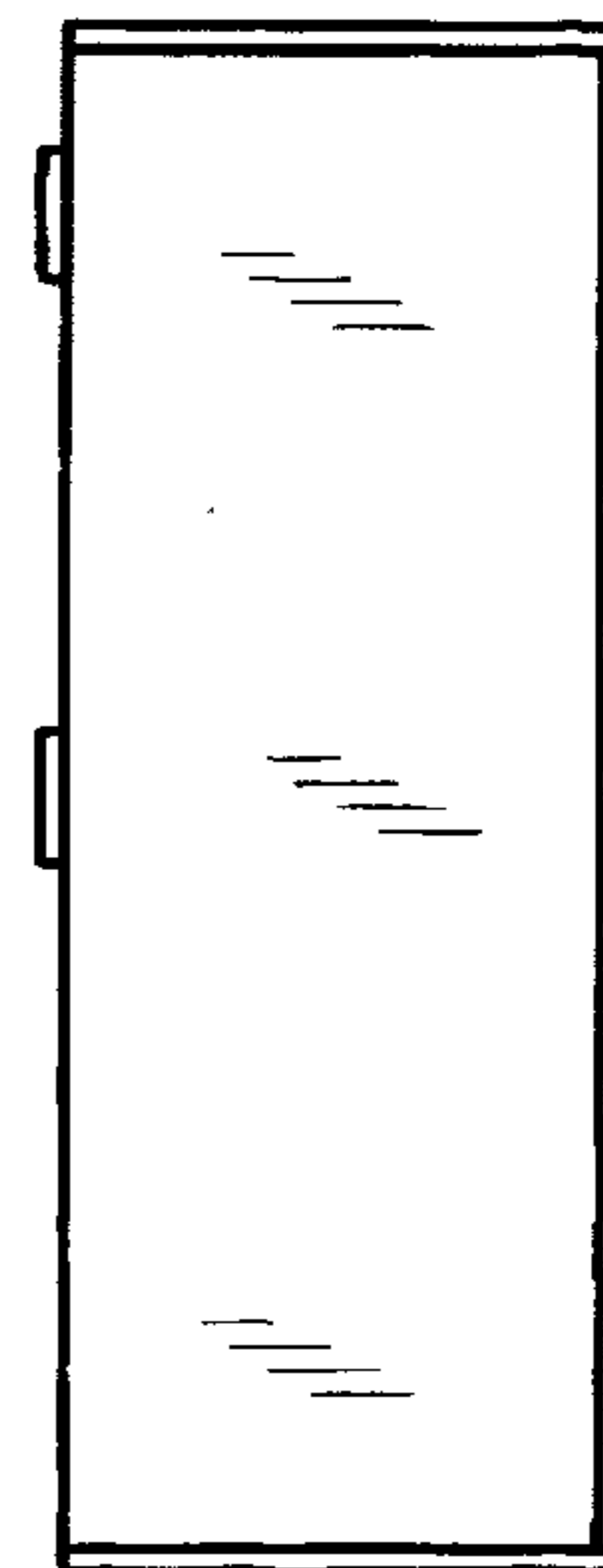

FIG. 2

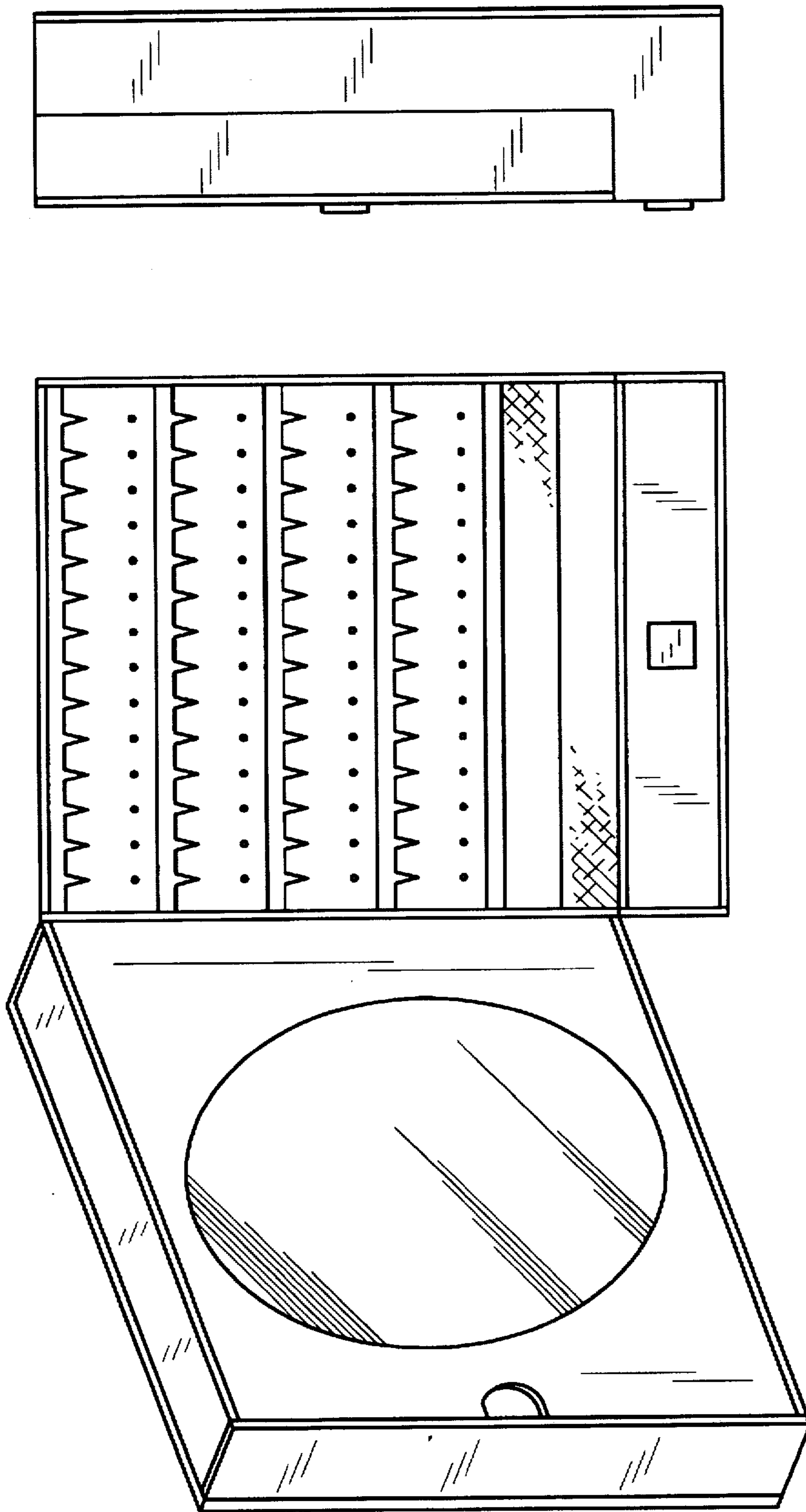

FIG. 5

FIG. 6

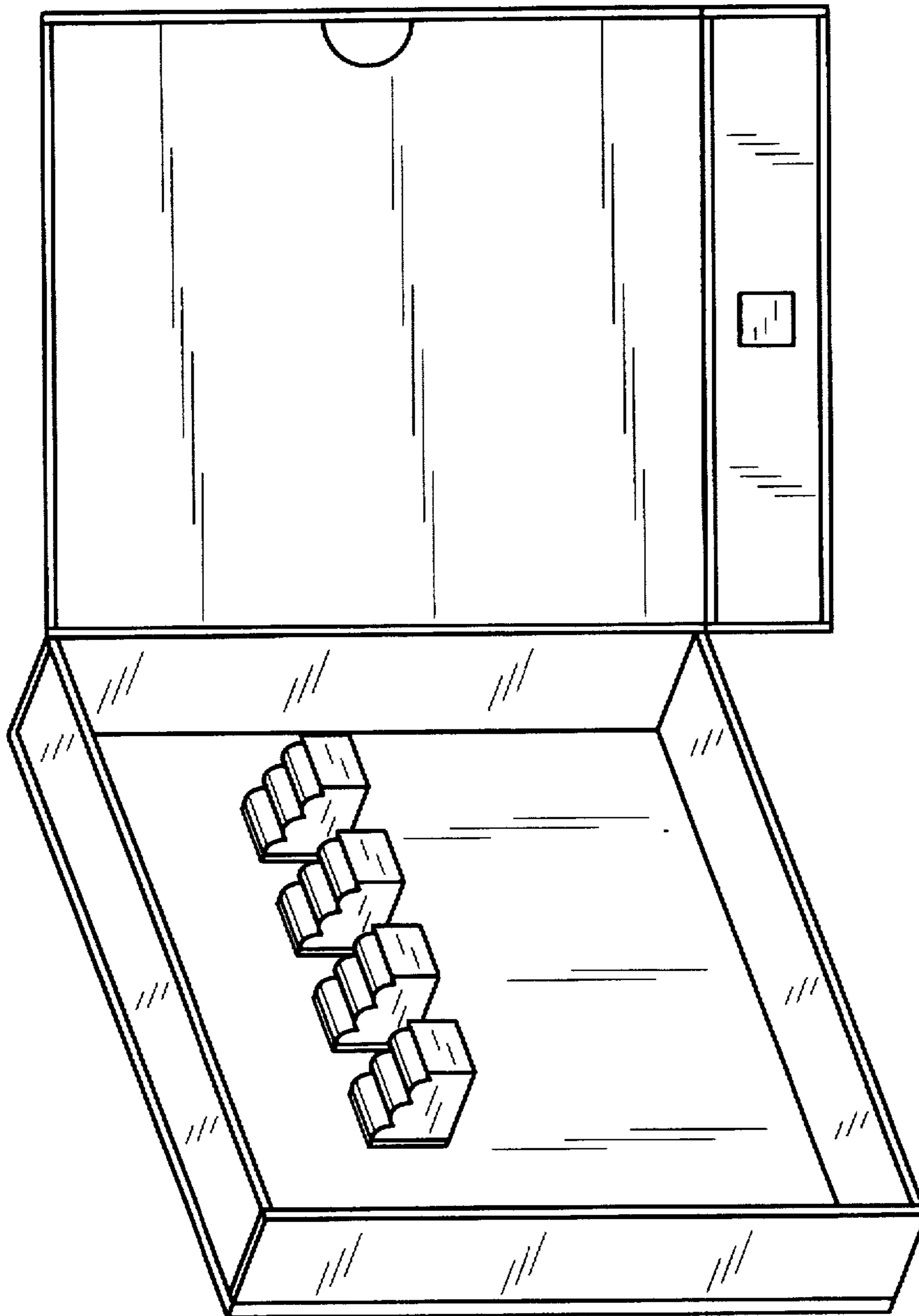

FIG. 7