

US00D396829S

United States Patent [19]

Takashima et al.

[11] Patent Number: **Des. 396,829**

[45] Date of Patent: ****Aug. 11, 1998**

[54] **AUTOMOBILE**

[75] Inventors: **Shinji Takashima; Toshihiko Shimizu,**
both of Wako, Japan

[73] Assignee: **Honda Giken Kogyo Kabushiki**
Kaisha, Tokyo, Japan

[**] Term: **14 Years**

[21] Appl. No.: **57,882**

[22] Filed: **Aug. 2, 1996**

[30] **Foreign Application Priority Data**

Mar. 8, 1996 [JP] Japan 8-6387

[51] LOC (6) Cl. **12-08**

[52] U.S. Cl. **D12/92**

[58] Field of Search **D12/90-92; 296/185**

[56] **References Cited**

U.S. PATENT DOCUMENTS

- D. 347,806 6/1994 Kurosu et al. D12/92
- D. 354,258 1/1995 Ikeda et al. D12/91
- D. 357,211 4/1995 Choi D12/92
- D. 370,876 6/1996 Santoro et al. D12/92

- D. 373,332 9/1996 Udogawa et al. D12/92
- D. 373,333 9/1996 Ishibashi et al. D12/92
- D. 373,334 9/1996 Honda et al. D12/92
- D. 379,946 6/1997 Tanabe et al. D12/92

OTHER PUBLICATIONS

1996 Dodge Stratus Brochure.

Primary Examiner—Melody N. Brown
Attorney, Agent, or Firm—Nikaido, Marmelstein, Murray &
Oram LLP

[57] **CLAIM**

The ornamental design for an automobile, as shown and described.

DESCRIPTION

FIG. 1 is a left-front perspective view of an automobile showing our new design;
FIG. 2 is a left-rear perspective view thereof;
FIG. 3 is a left side view thereof;
FIG. 4 is a right side view thereof;
FIG. 5 is a front view thereof;
FIG. 6 is a rear view thereof; and,
FIG. 7 is a top plan view thereof.

1 Claim, 6 Drawing Sheets

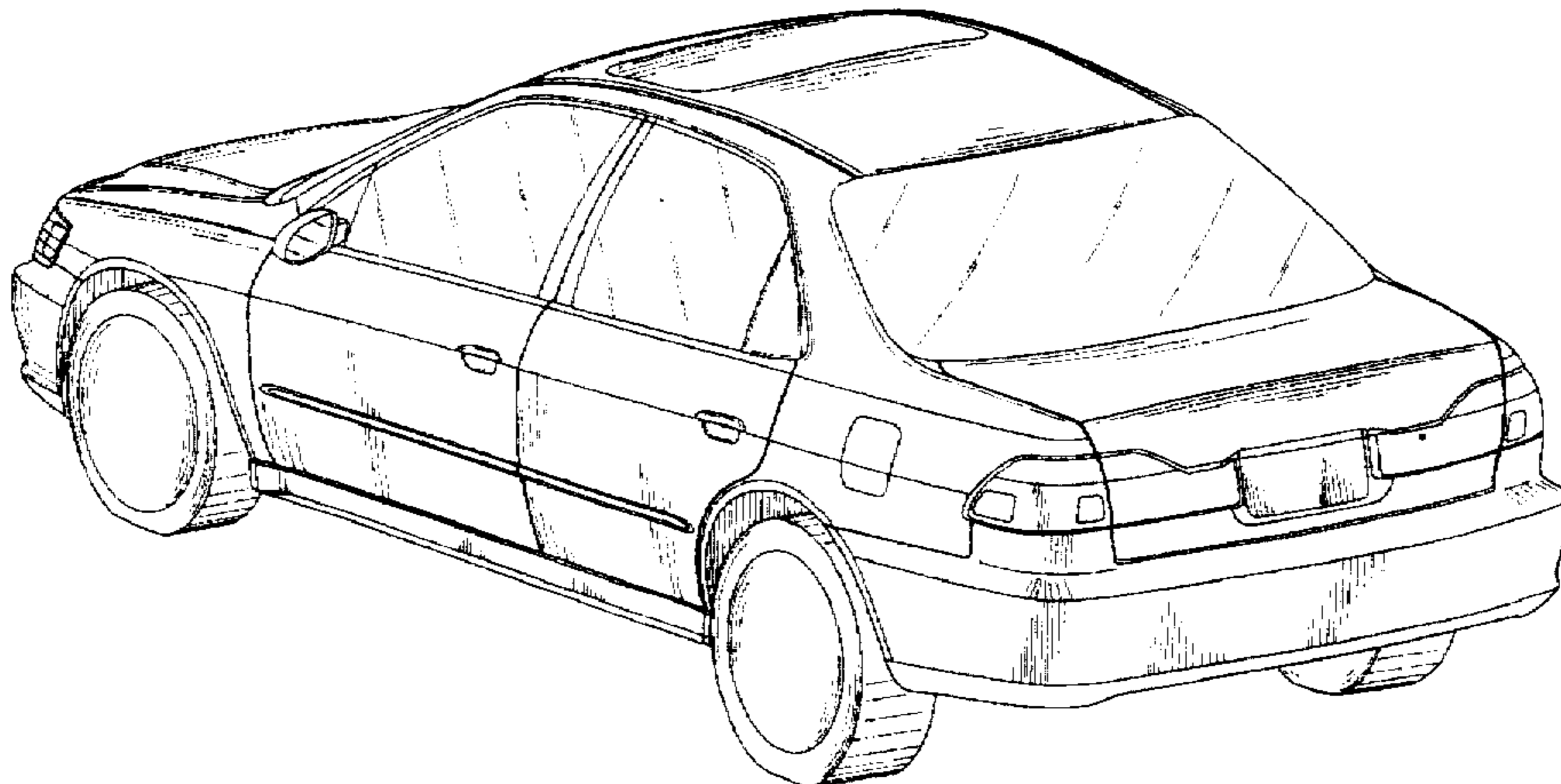
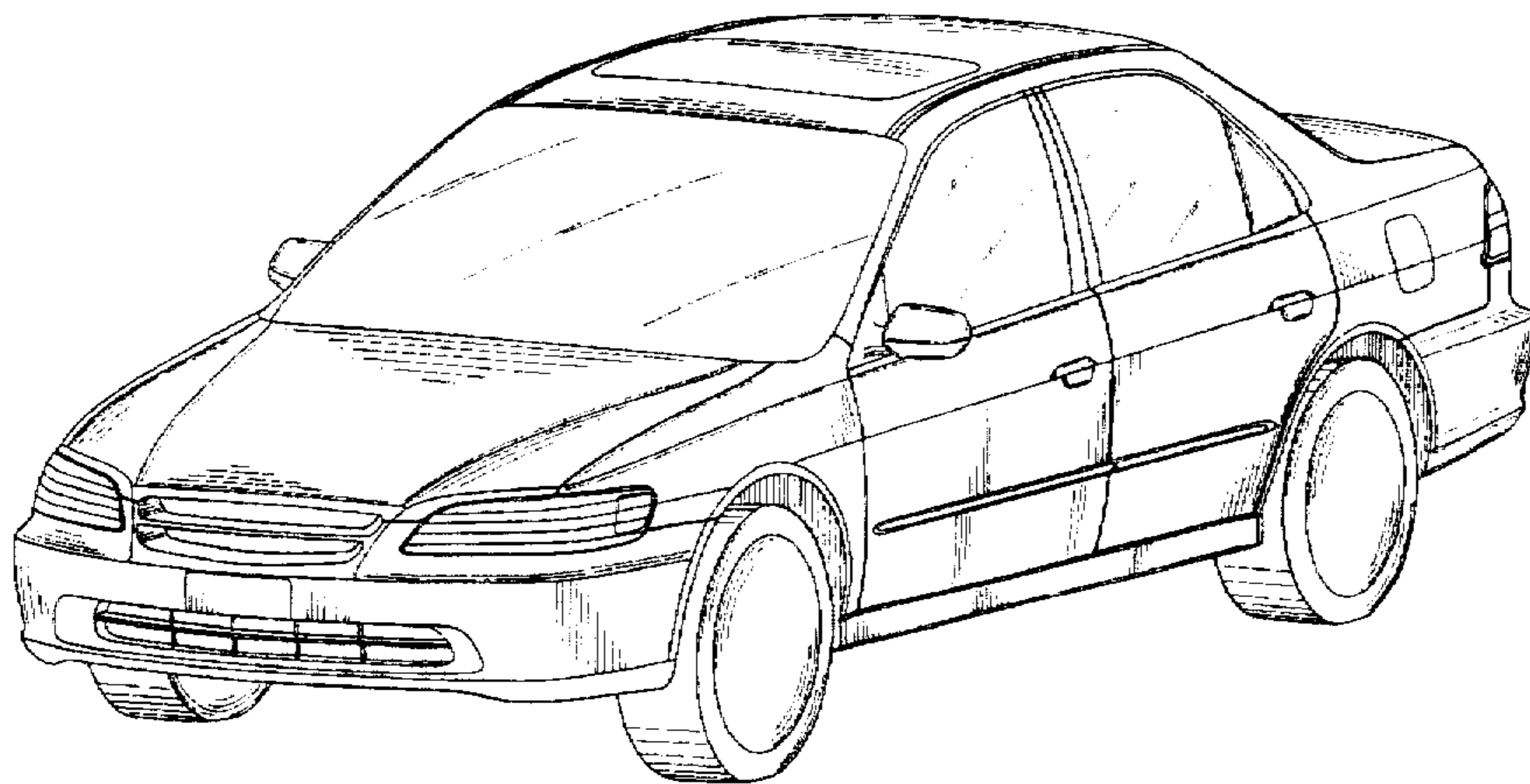

FIG.1

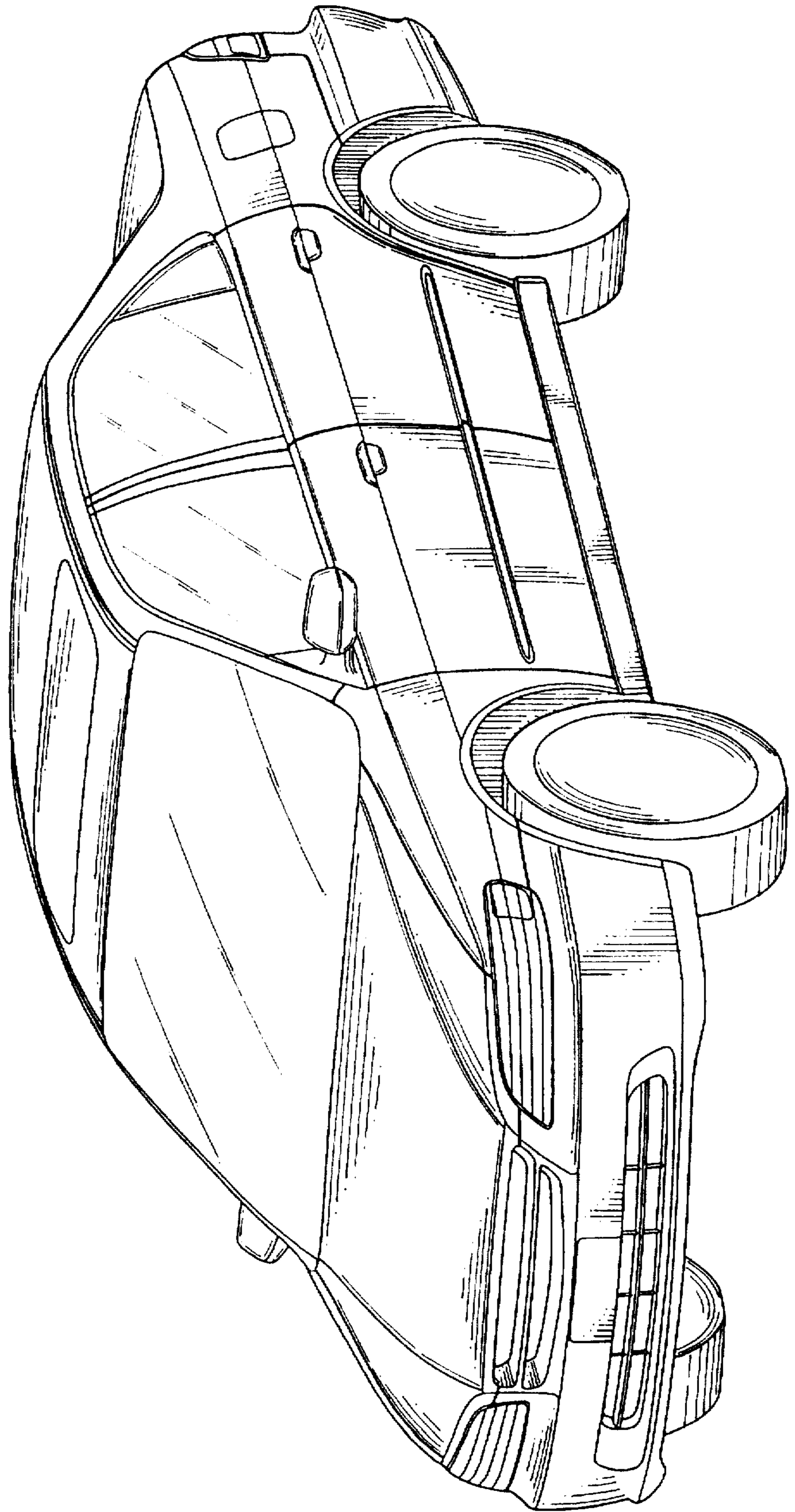

FIG. 2

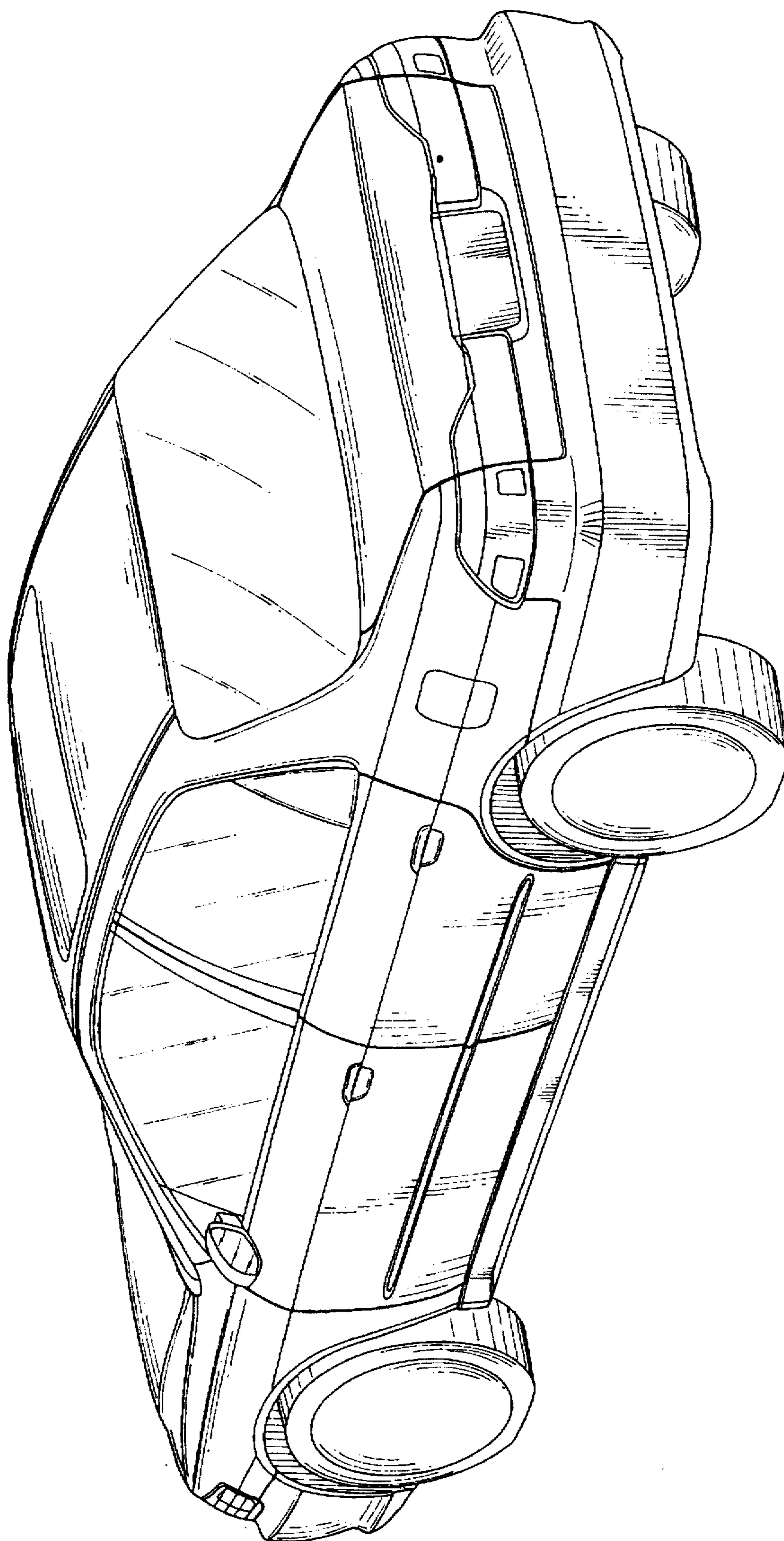

FIG. 3

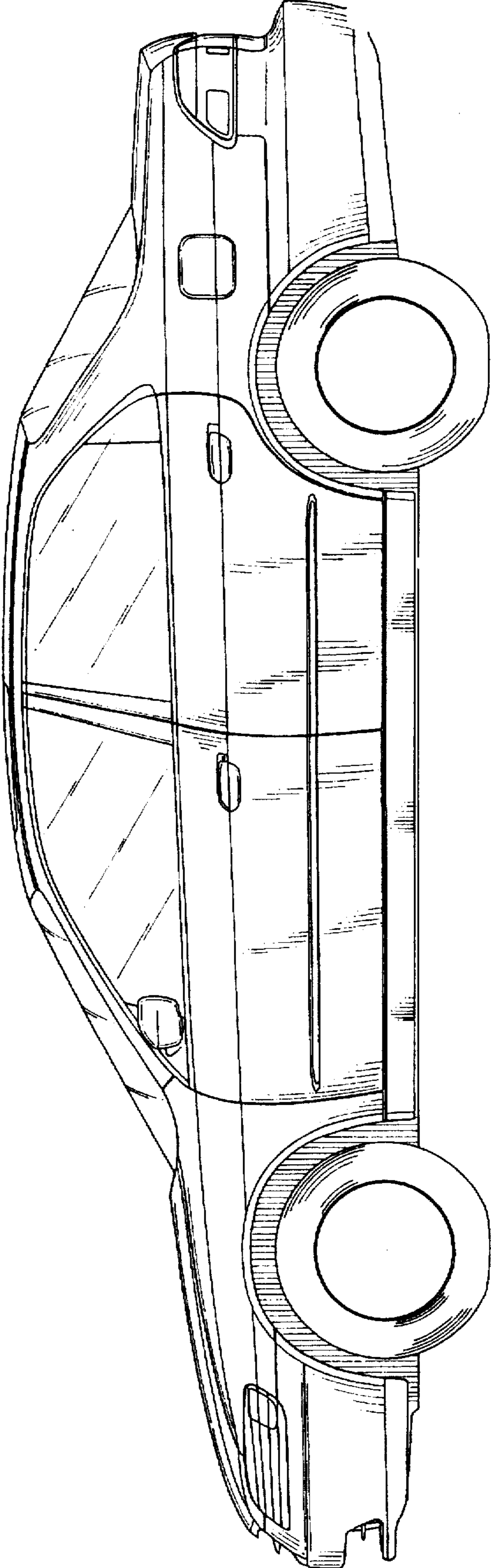

FIG. 4

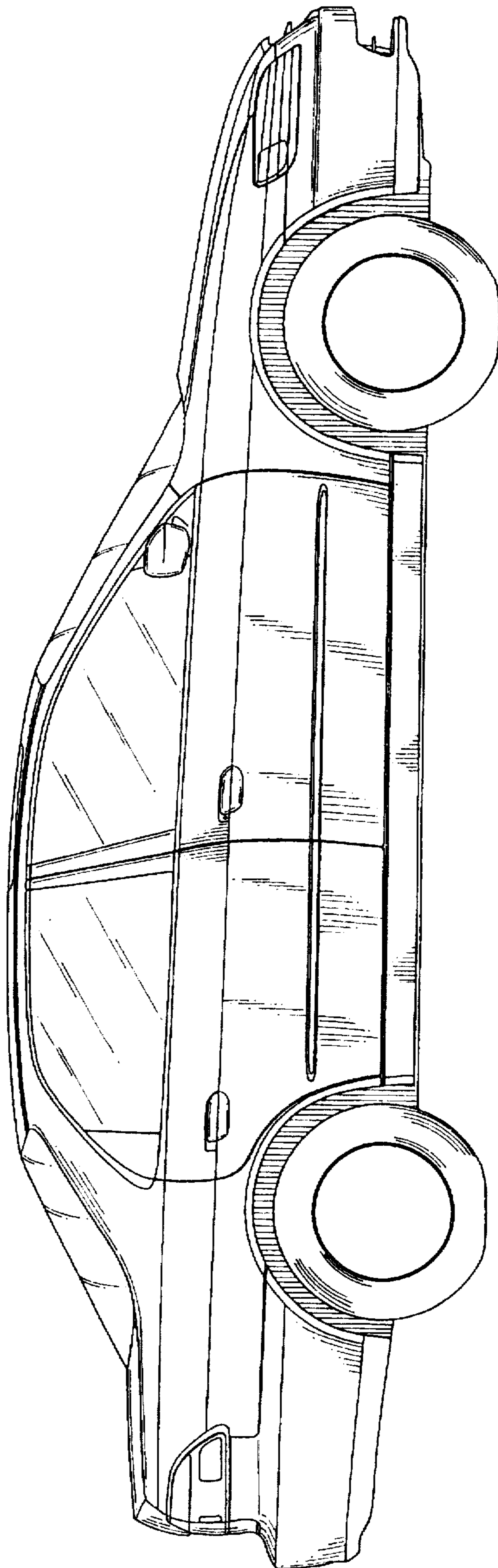

FIG. 6

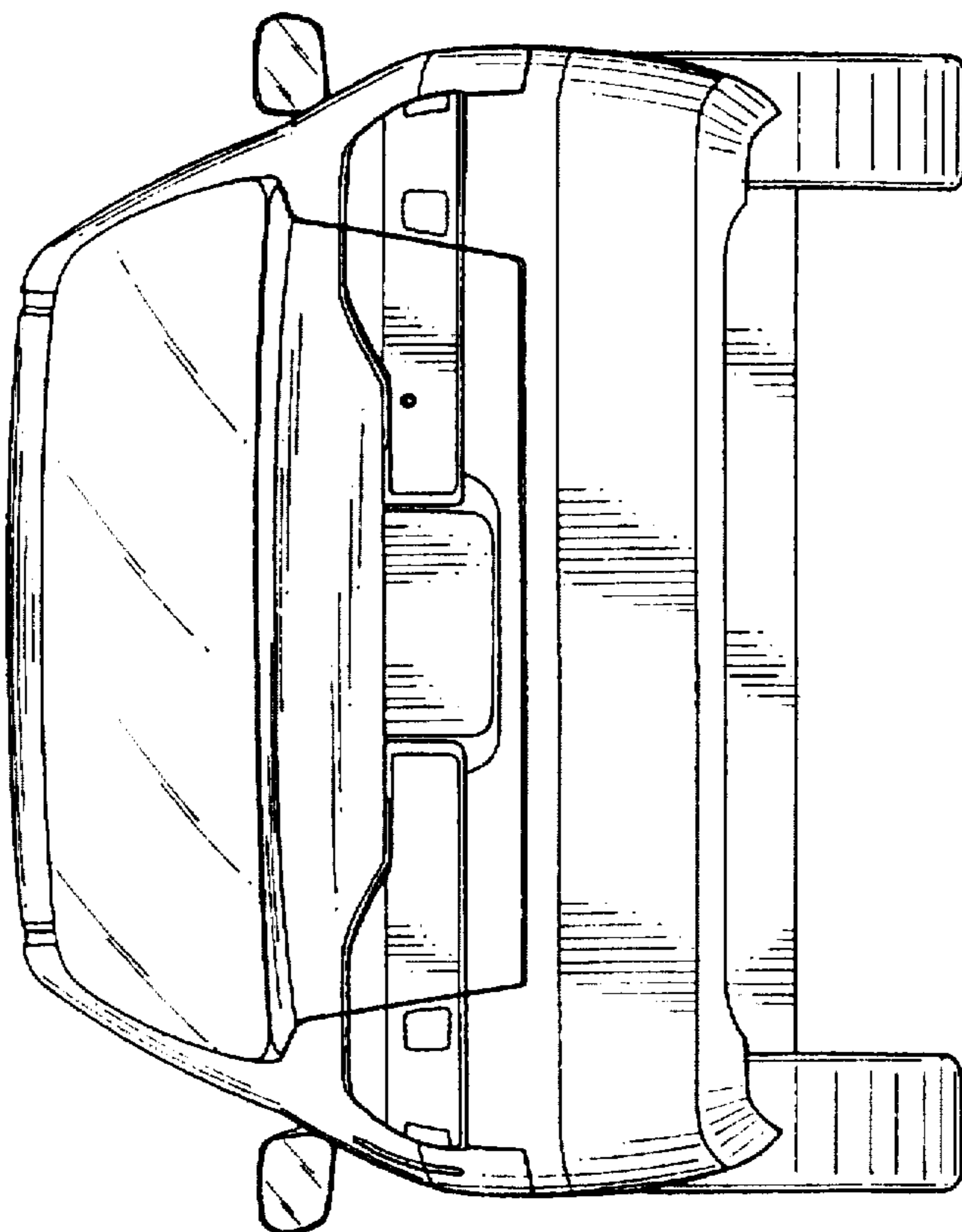

FIG. 5

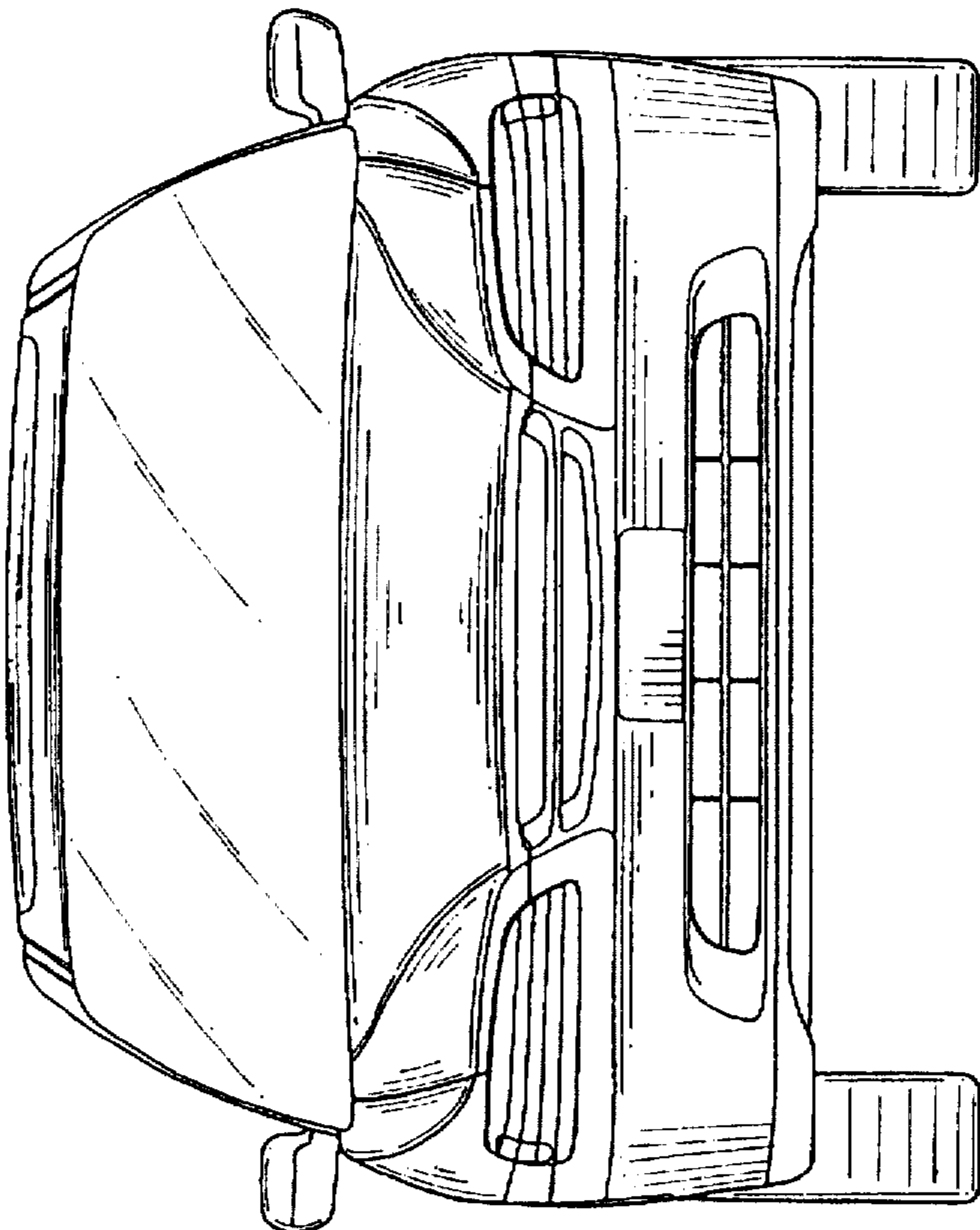

FIG. 7

