



US00D396793S

United States Patent [19]
Magnusson

[11] **Patent Number: Des. 396,793**
[45] **Date of Patent: **Aug. 11, 1998**

[54] **FURNITURE PULL**

4,156,794 5/1979 Robinson .

[75] **Inventor: Carl G. Magnusson, New York, N.Y.**

OTHER PUBLICATIONS

[73] **Assignee: Knoll, Inc., East Greenville, Pa.**

Amerock Brochure; Contemporary Cabinet Hardware; Front Page; Pull AD424.
Hone Hardware Cab; p. 13, Pull 530.

[**] **Term: 14 Years**

Primary Examiner—B. J. Bullock
Attorney, Agent, or Firm—Buchanan Ingersoll, P.C.

[21] **Appl. No.: 72,057**

[22] **Filed: Jun. 6, 1997**

[57] **CLAIM**

[51] **LOC (6) Cl. 08-06**

[52] **U.S. Cl. D8/319; D8/320**

[58] **Field of Search D8/300, 315-320;
16/110 R. 111 R. 124**

The ornamental design for a furniture pull, as shown and described.

DESCRIPTION

[56] **References Cited**

FIG. 1 is a perspective view of a furniture pull showing my new design;
FIG. 2 is a front elevational view thereof;
FIG. 3 is a rear elevational view thereof;
FIG. 4 is a right side elevational view thereof, the left side being a mirror image thereof;
FIG. 5 is a top plan view thereof; and,
FIG. 6 is a bottom plan view thereof.

U.S. PATENT DOCUMENTS

- D. 109,125 4/1938 Carlson .
- D. 116,497 9/1939 Lingard .
- D. 198,836 8/1964 Smith .
- D. 201,542 7/1965 Pawl .
- D. 361,255 8/1995 Crinion .
- 3,145,050 8/1964 Edwards .

1 Claim, 2 Drawing Sheets

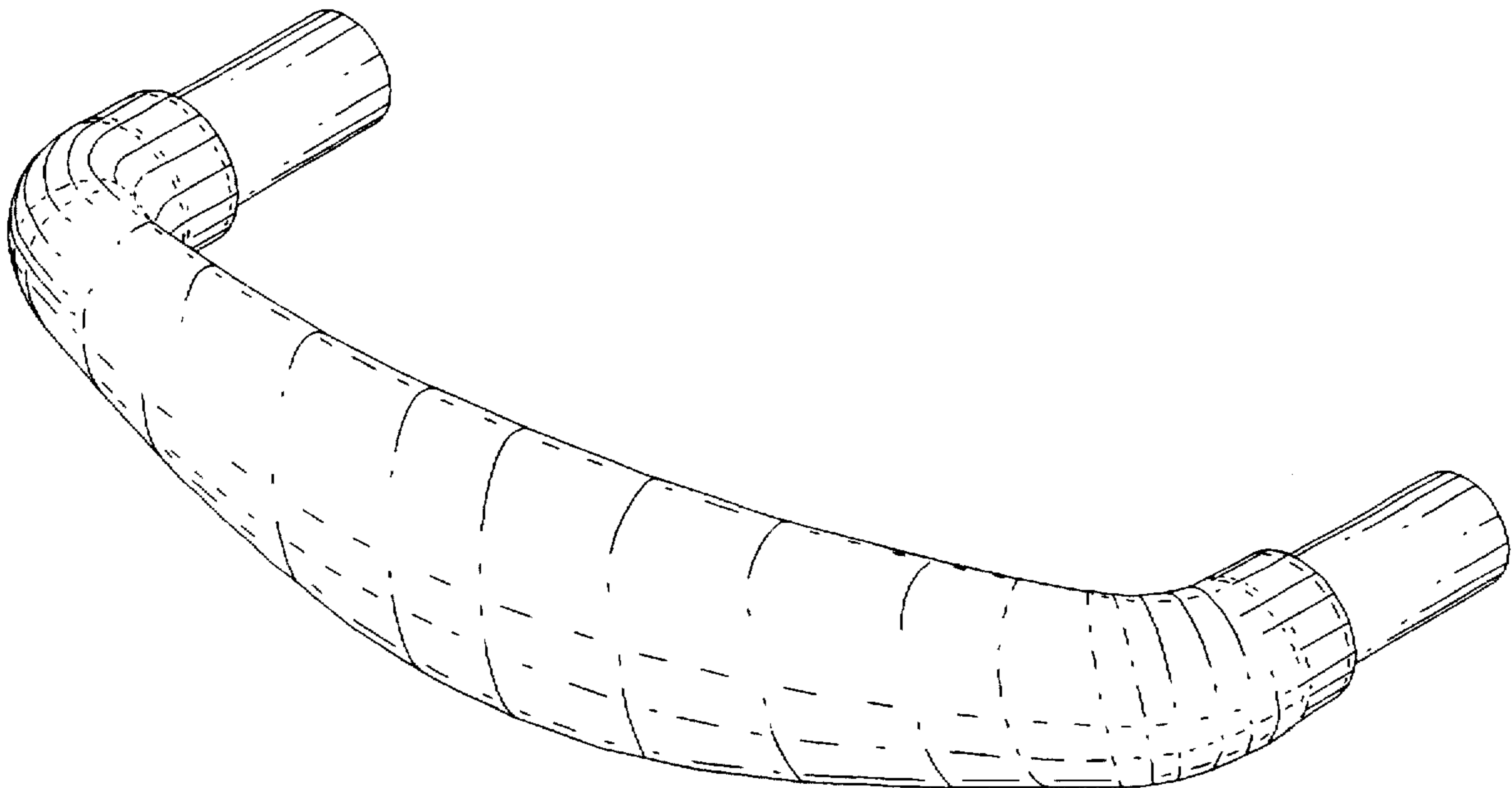

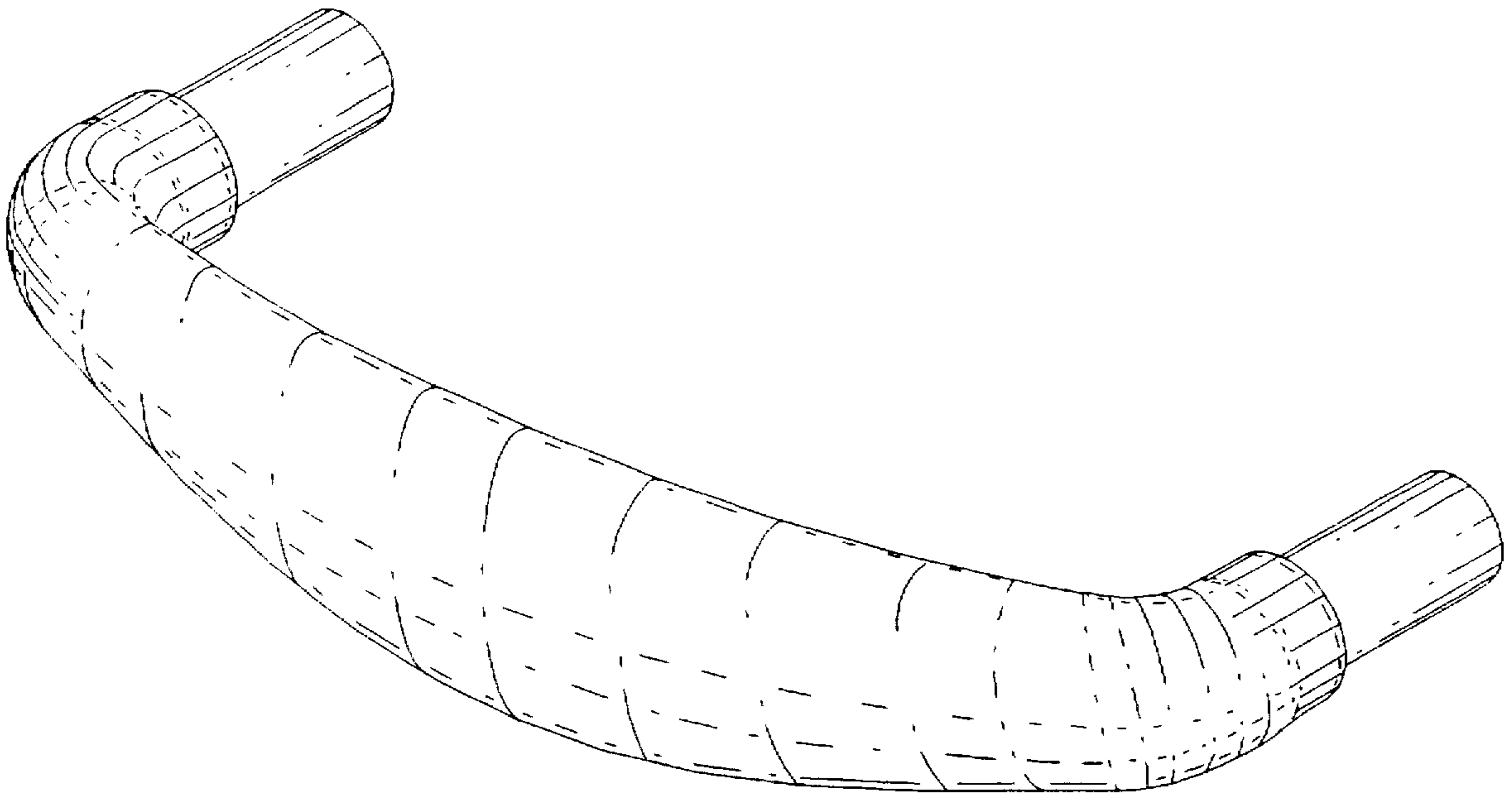

FIG. 1

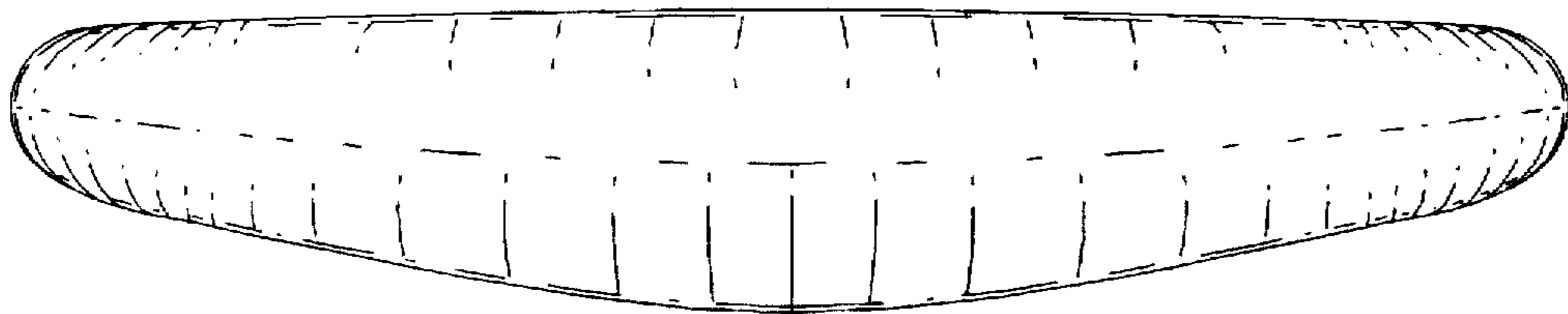

FIG. 2

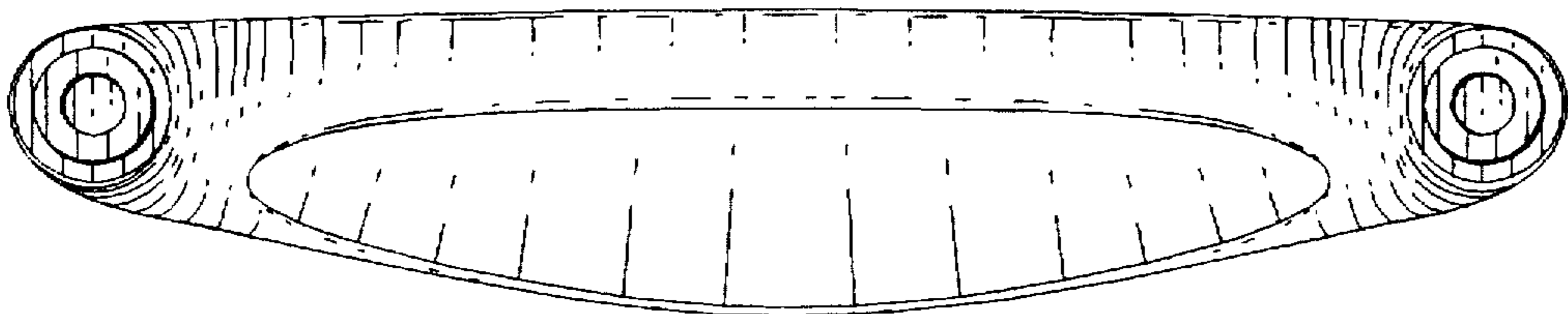

FIG. 3

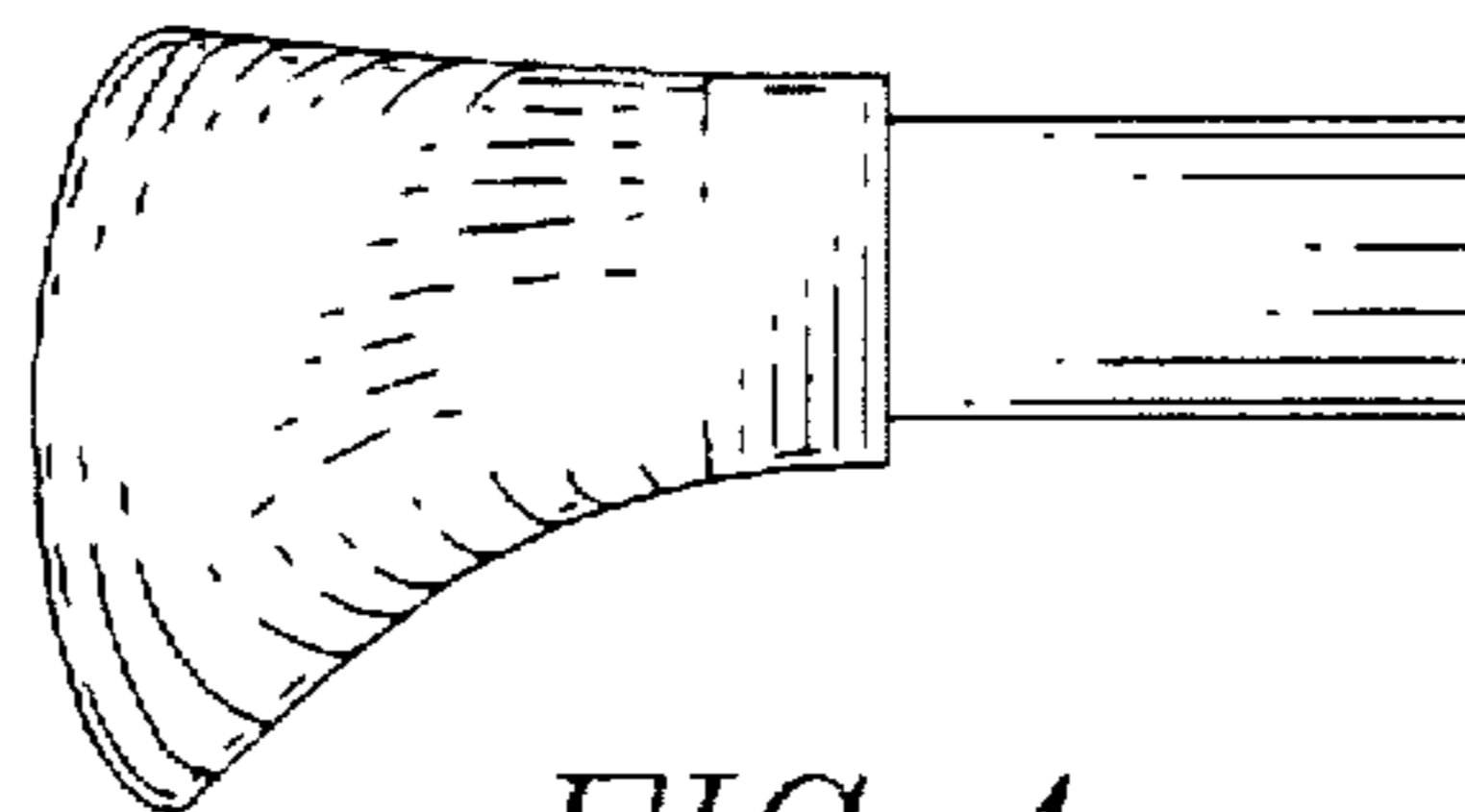

FIG. 4

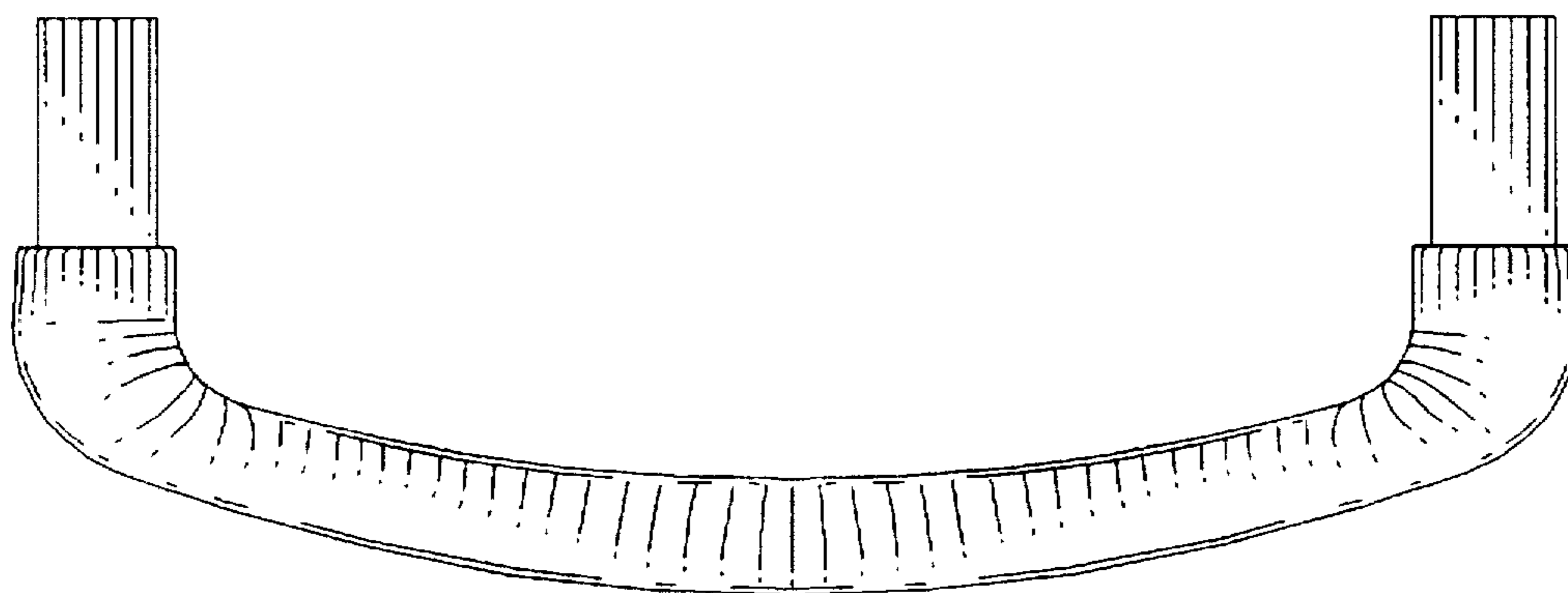

FIG. 5

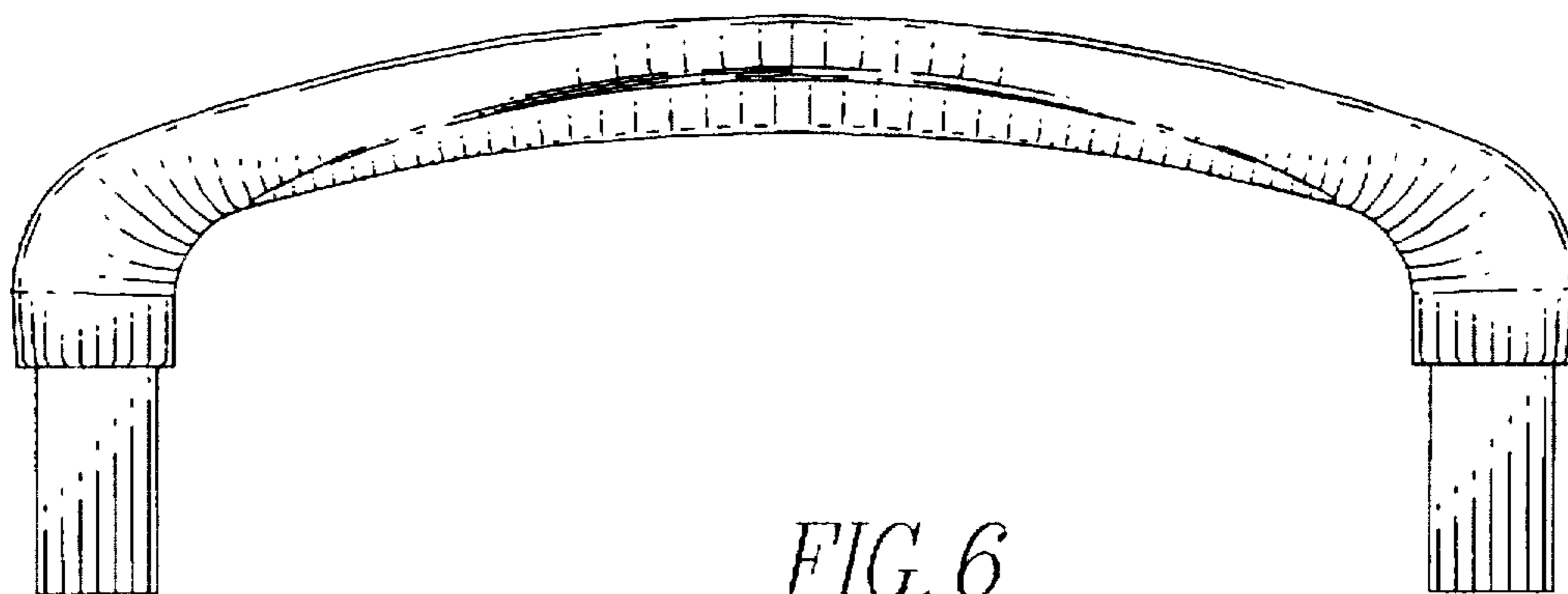

FIG. 6