



US00D396718S

United States Patent [19]

[11] Patent Number: Des. 396,718

Mohri

[45] Date of Patent: **Aug. 4, 1998

[54] COMBINED RADIO AND DISC PLAYER

[57] CLAIM

[75] Inventor: Akinari Mohri, Tokyo, Japan

The ornamental design for a combined radio and disc player, as shown and described.

[73] Assignee: Sony Corporation, Tokyo, Japan

DESCRIPTION

[**] Term: 14 Years

[21] Appl. No.: 66,542

FIG. 1 is a perspective view of a first embodiment of a combined radio and disc player showing my new design;

[22] Filed: Feb. 13, 1997

FIG. 2 is a top plan view thereof;

[51] LOC (6) Cl. 14-01

FIG. 3 is a left side elevational view thereof;

[52] U.S. Cl. D14/162; D14/168

FIG. 4 is a front elevational view thereof;

[58] Field of Search D14/124, 135, D14/136, 156, 160, 162, 164, 168-171, 188-198; 369/75.1, 77.1, 77.2; 455/344, 347, 350, 351

FIG. 5 is a bottom plan view thereof;

FIG. 6 is a right side elevational view thereof;

FIG. 7 is a rear elevational view thereof;

FIG. 8 is a perspective view of a second embodiment of a combined radio and disc player showing my new design;

FIG. 9 is a top plan view of the embodiment of FIG. 8;

FIG. 10 is a left side elevational view of the embodiment of FIG. 8;

[56] References Cited

U.S. PATENT DOCUMENTS

- D. 270,633 9/1983 Shindo et al. D14/136
- D. 303,967 10/1989 Shin D14/162
- D. 338,463 8/1993 Hisatsune D14/156
- D. 377,650 1/1997 Obata D14/198 X

FIG. 11 is a front elevational view of the embodiment of FIG. 8;

FIG. 12 is a bottom plan view of the embodiment of FIG. 8;

FIG. 13 is a right side elevational view of the embodiment of FIG. 8;

FIG. 14 is a rear elevational view of the embodiment of FIG. 8; and,

OTHER PUBLICATIONS

Sony Portable Mini Disc Catalog, Sony Corp. (Mar. 1996).

FIG. 15 is a perspective view of the embodiment of FIG. 8, shown in an open position.

The views of the inside of the combined radio and disc player form no part of the claimed design.

Primary Examiner—Sandra L. Morris
Assistant Examiner—Nanda Bondade
Attorney, Agent, or Firm—Foley & Lardner

1 Claim, 6 Drawing Sheets

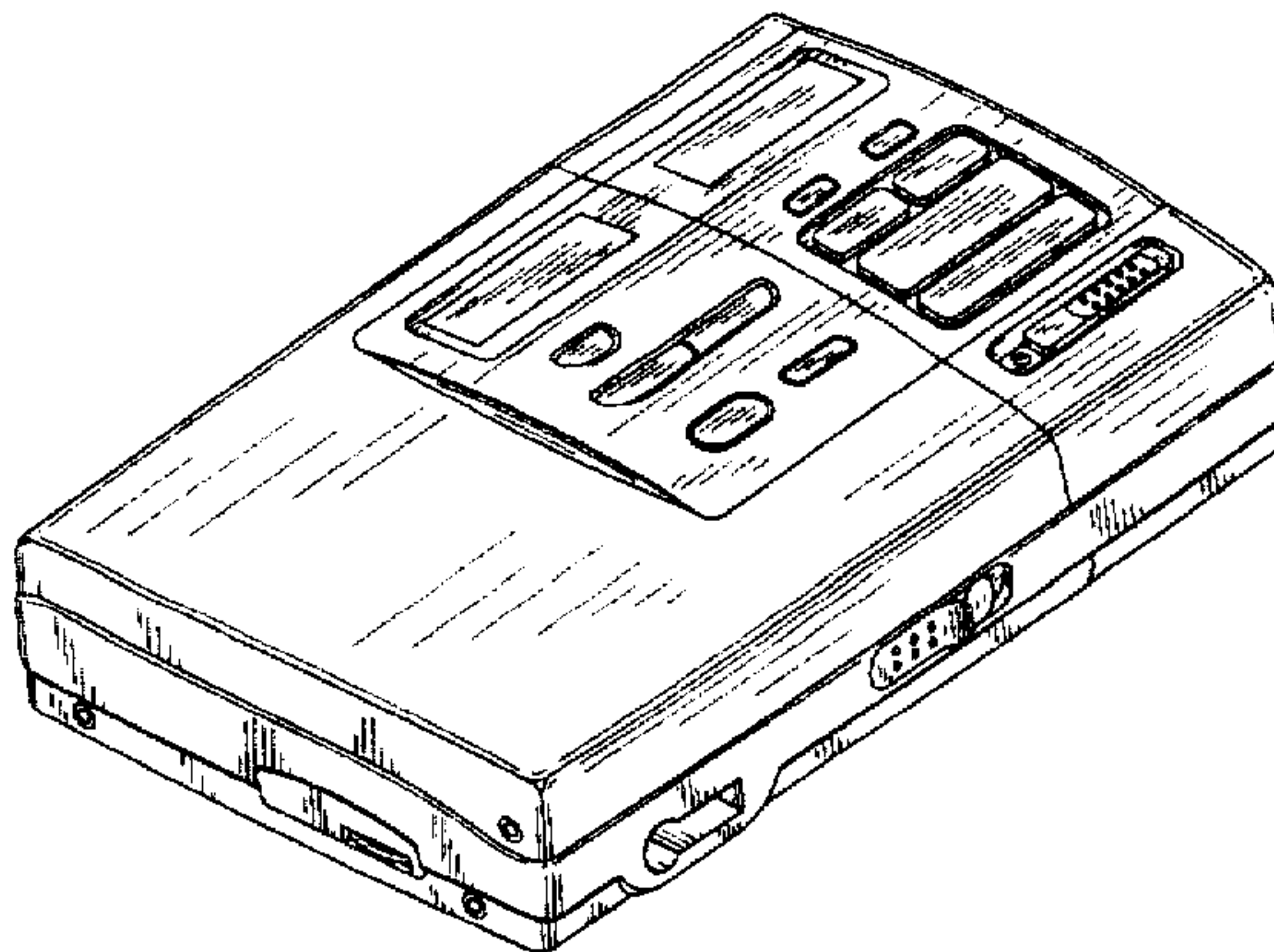
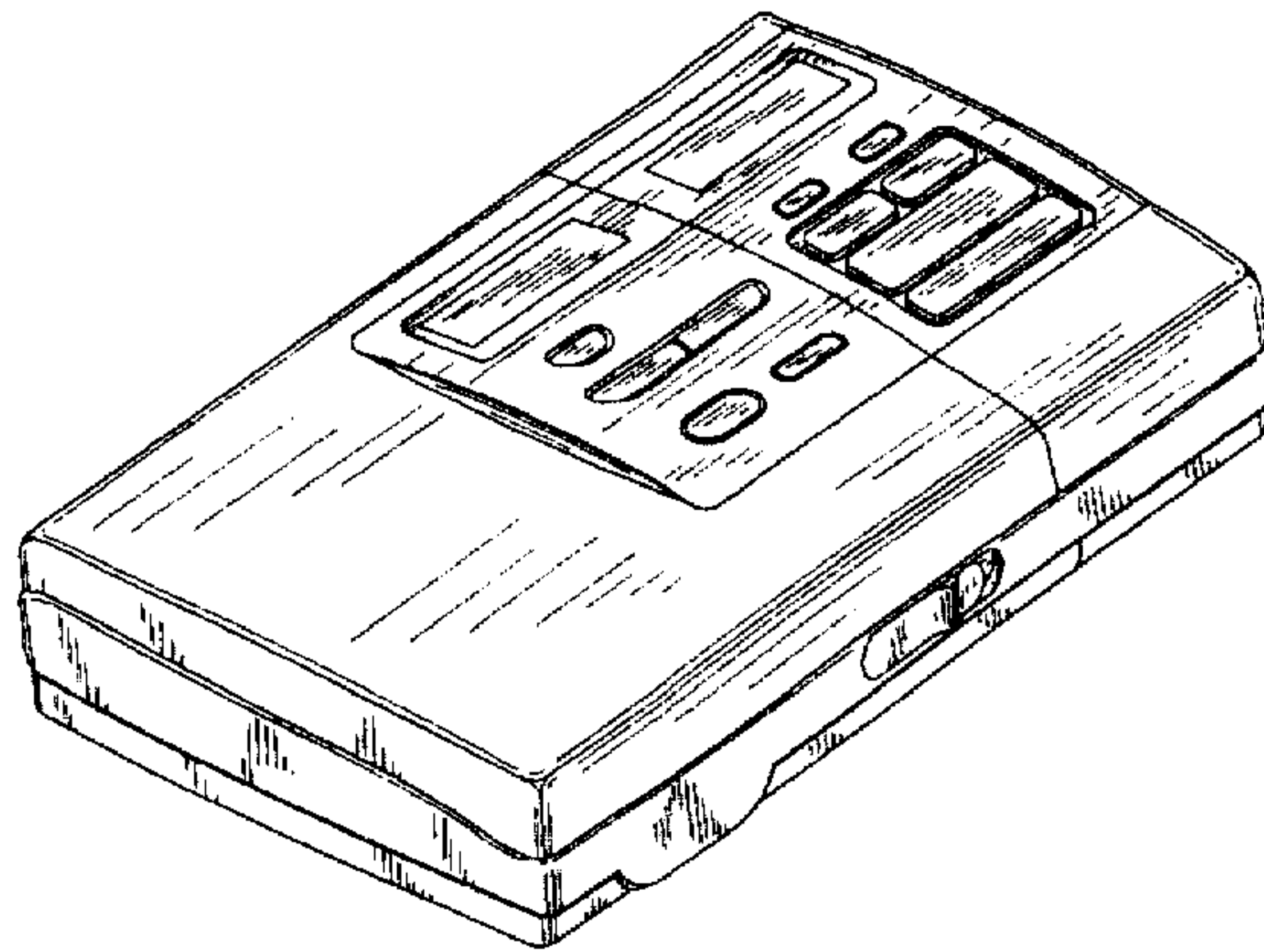

FIG. 1

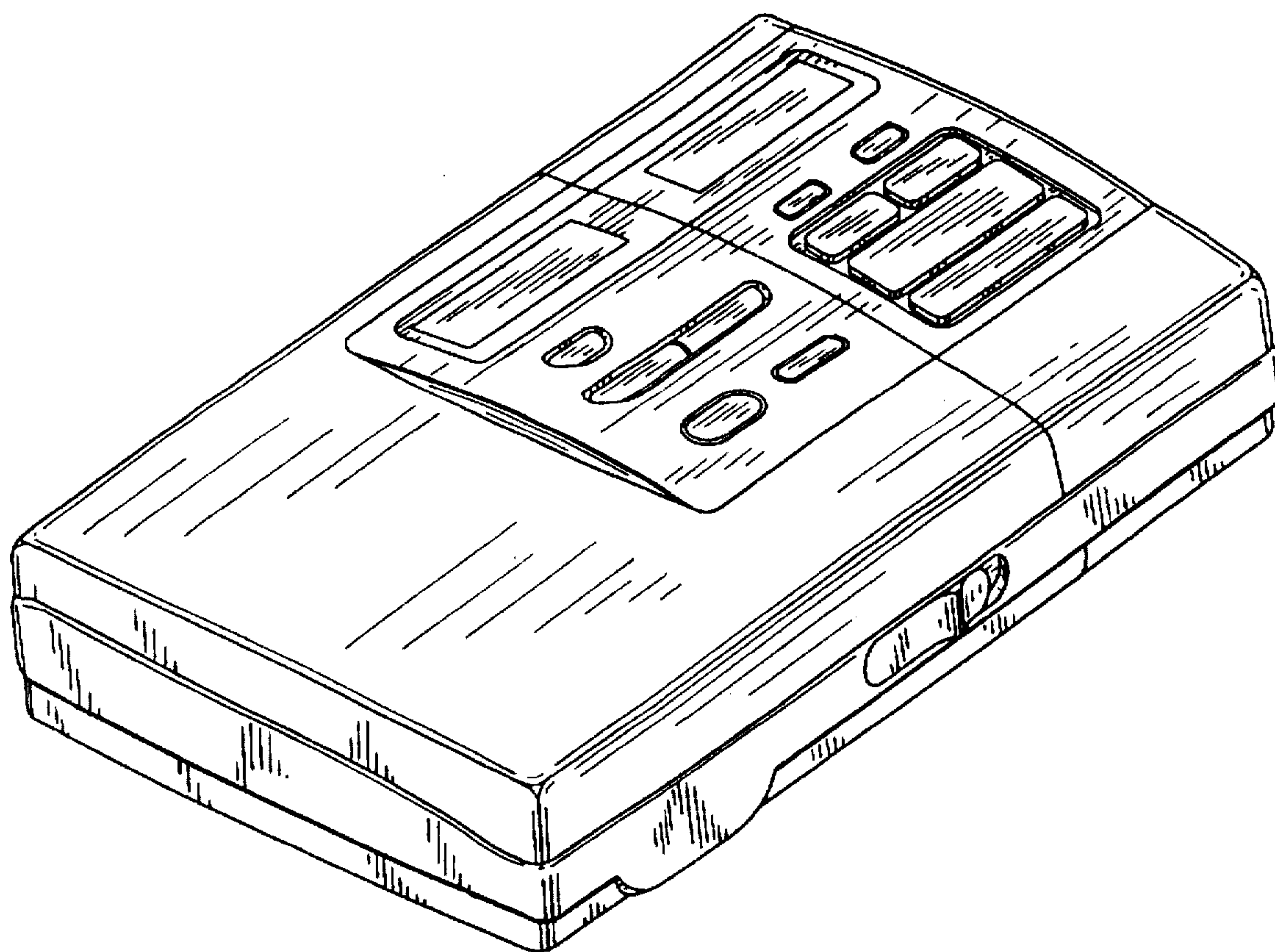

FIG. 5

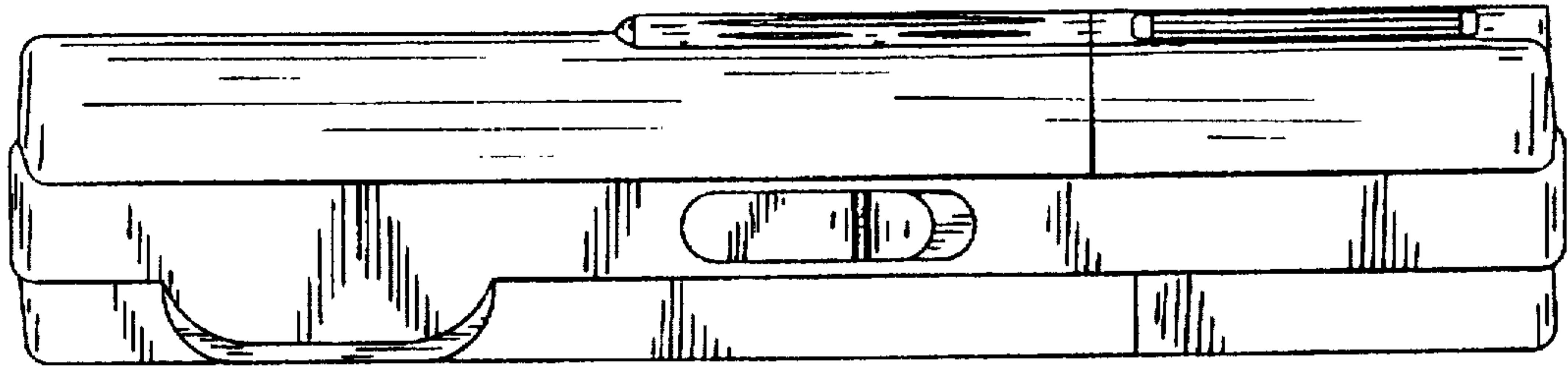

FIG. 2

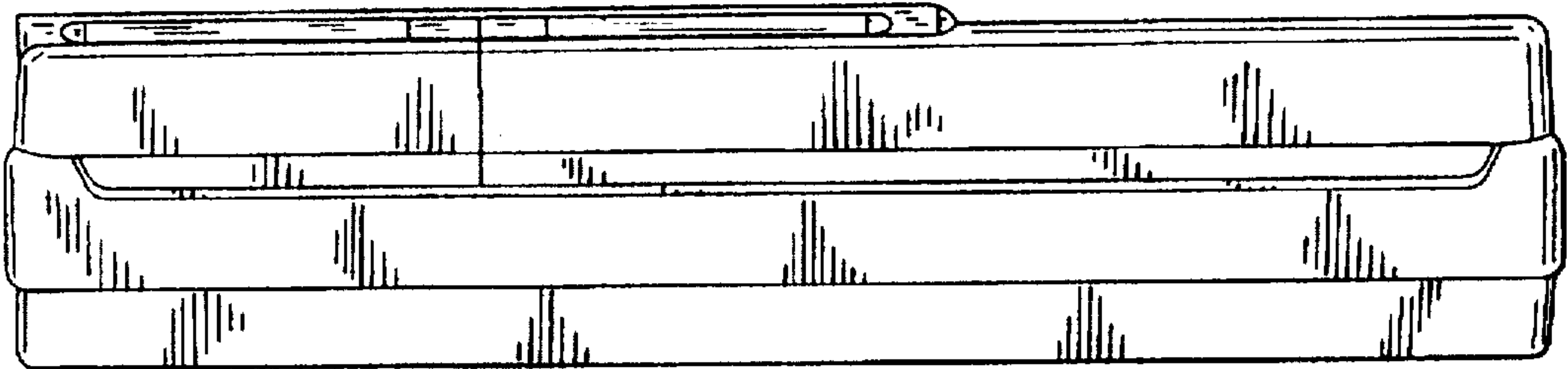

FIG. 3

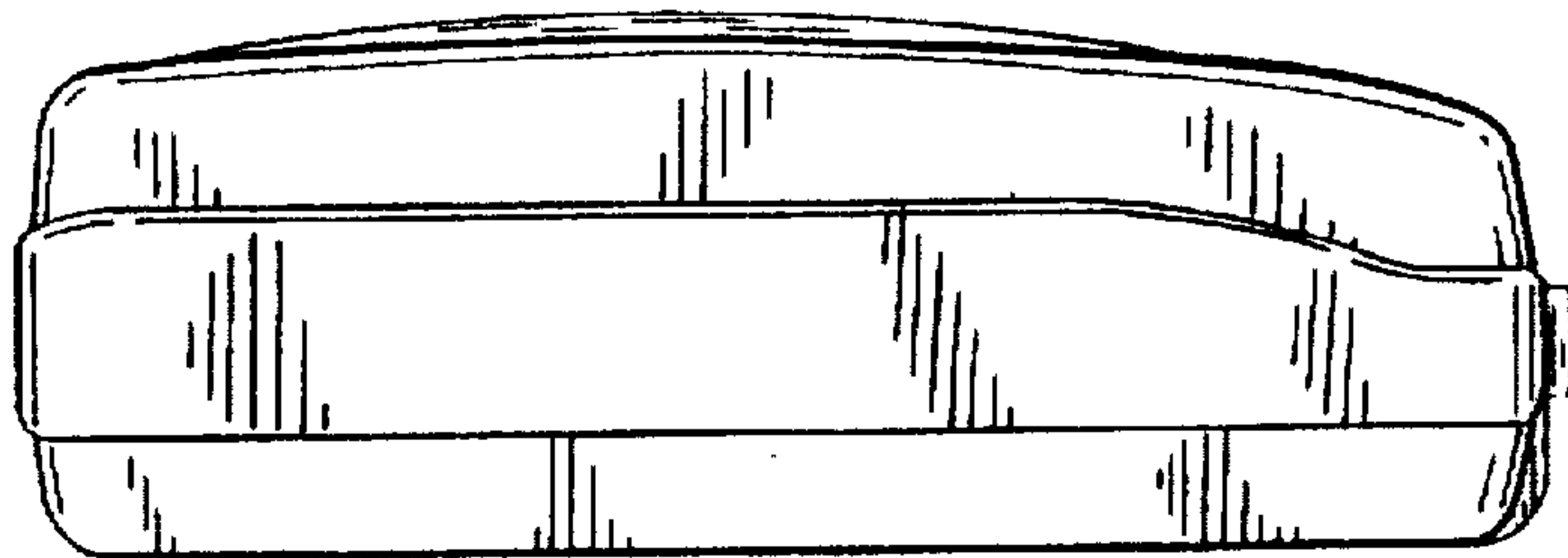

FIG. 6

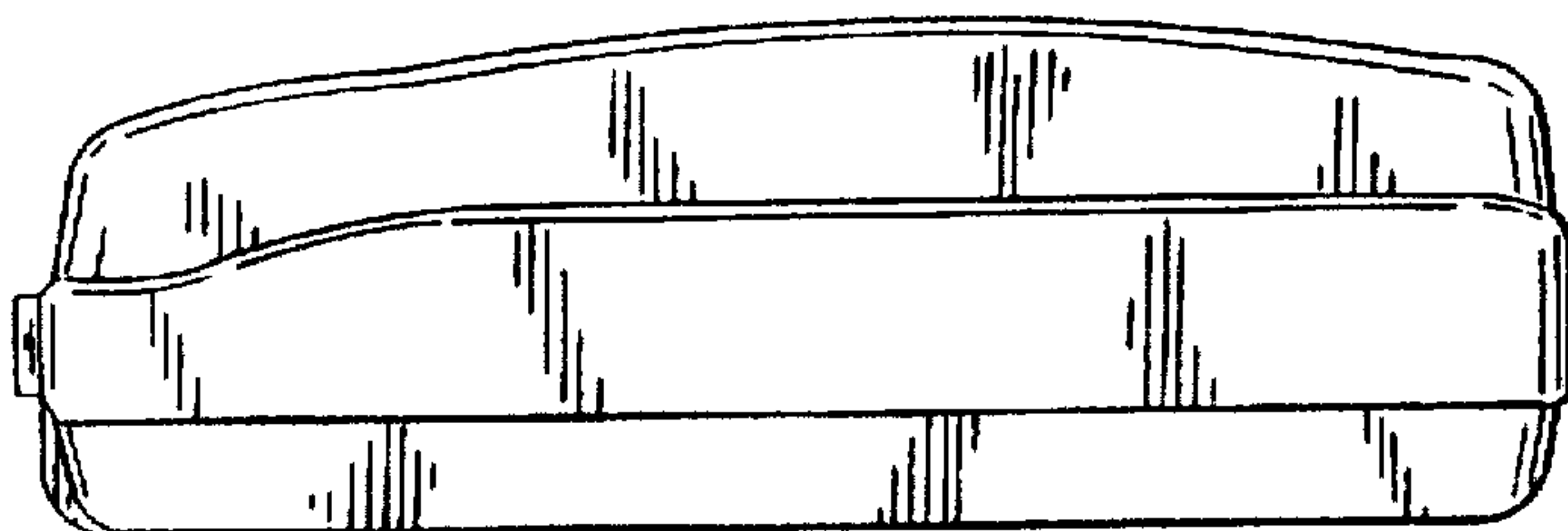

FIG. 4

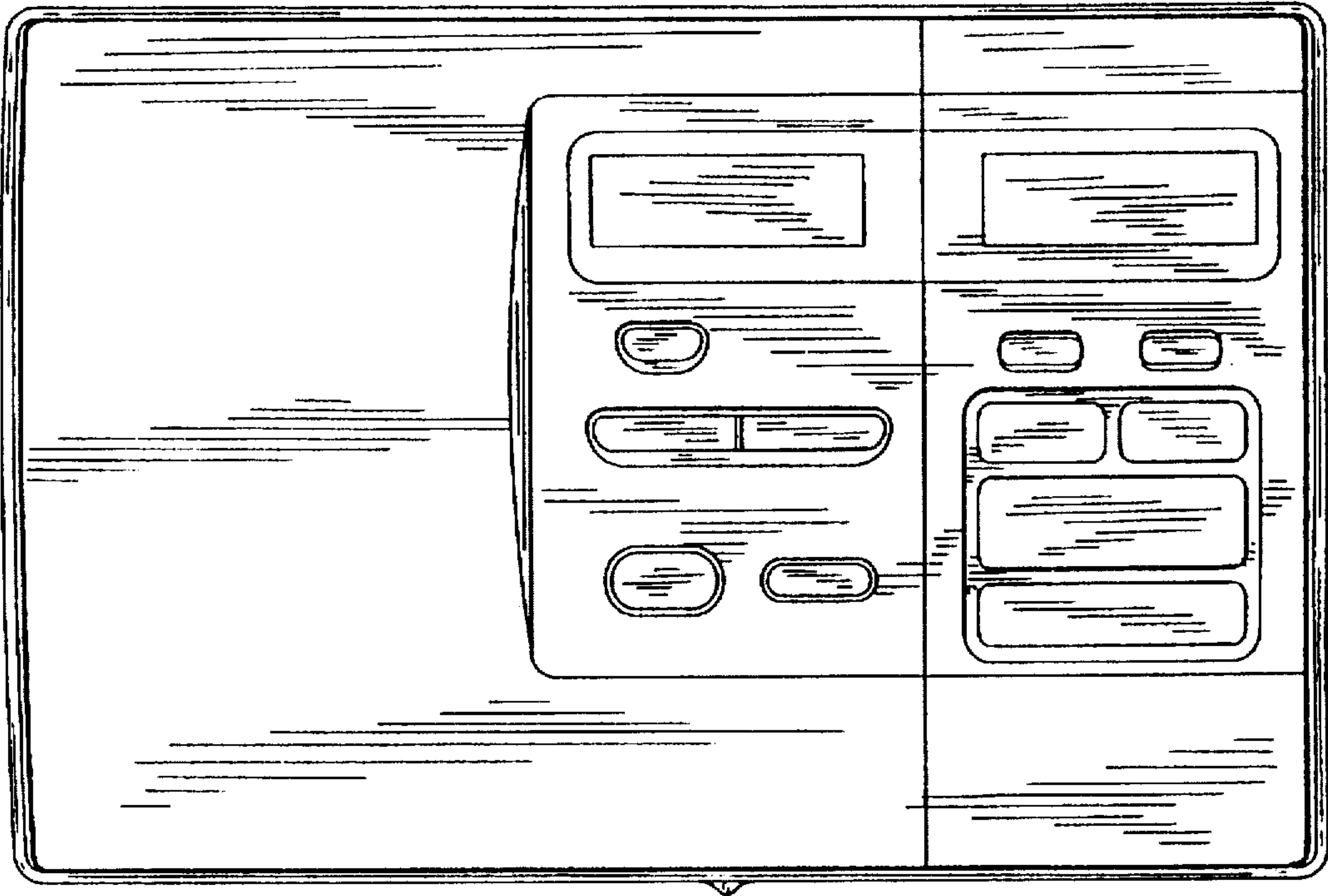

FIG. 7

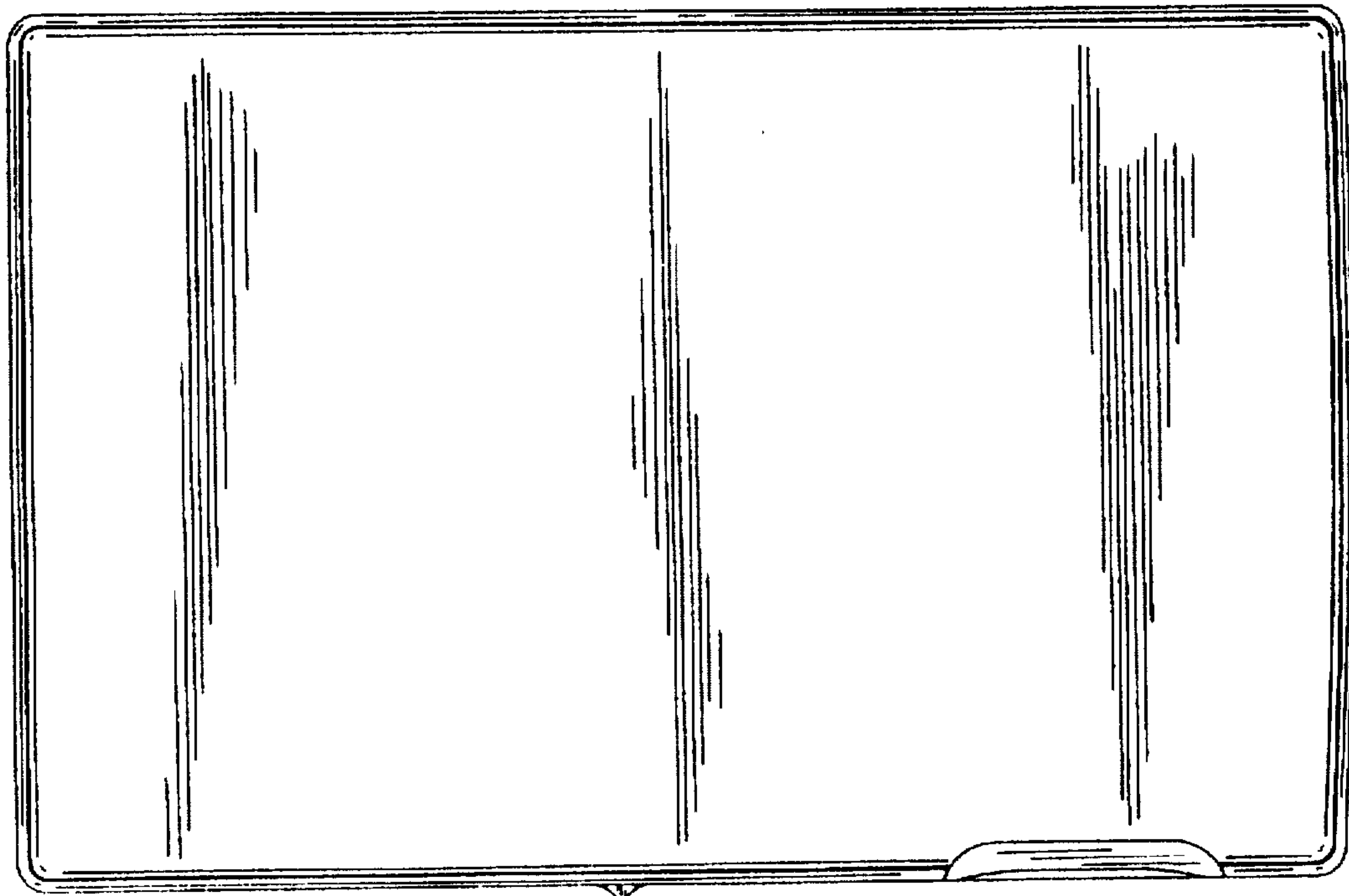

FIG. 8

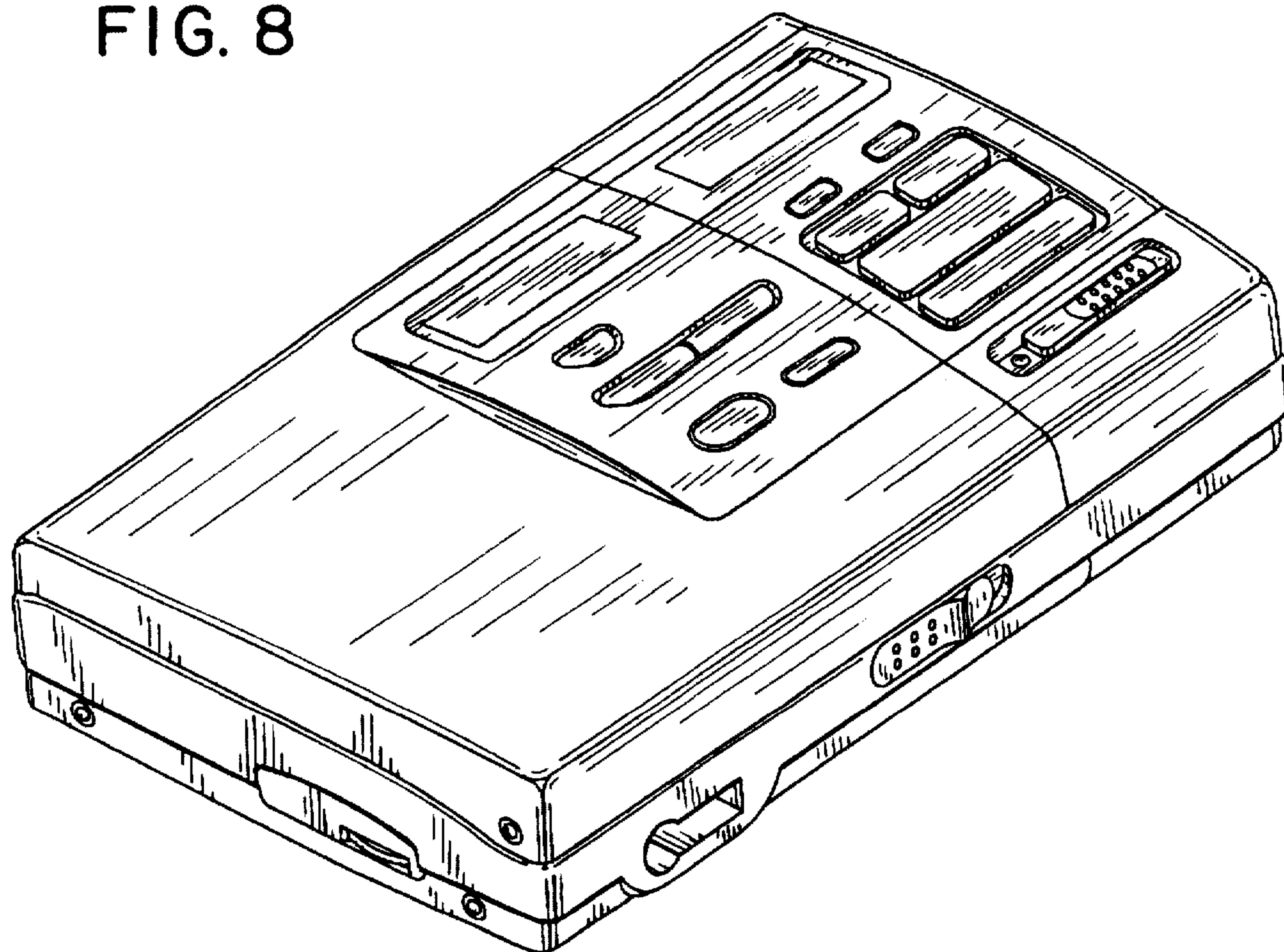

FIG. 15

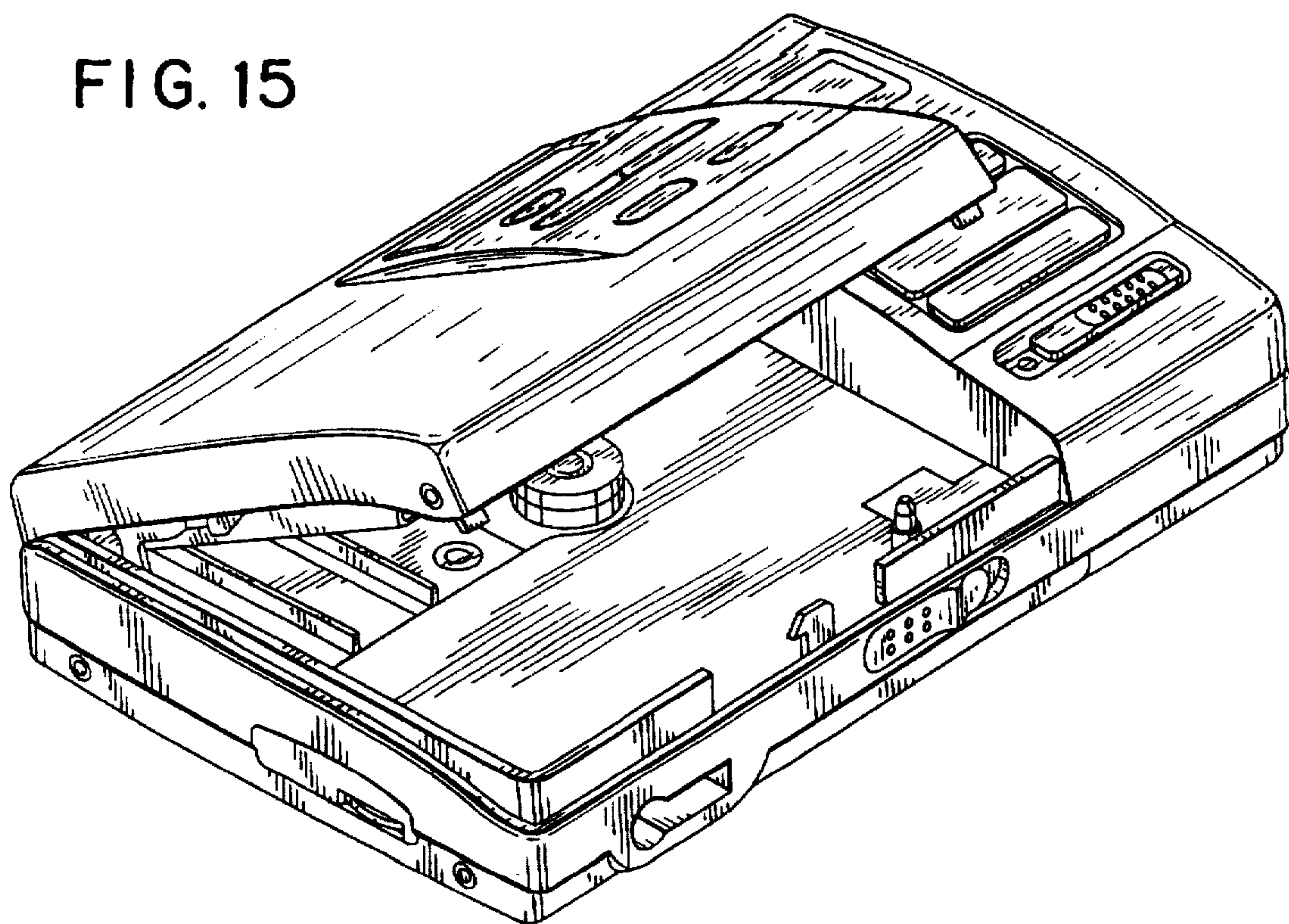

FIG. 12

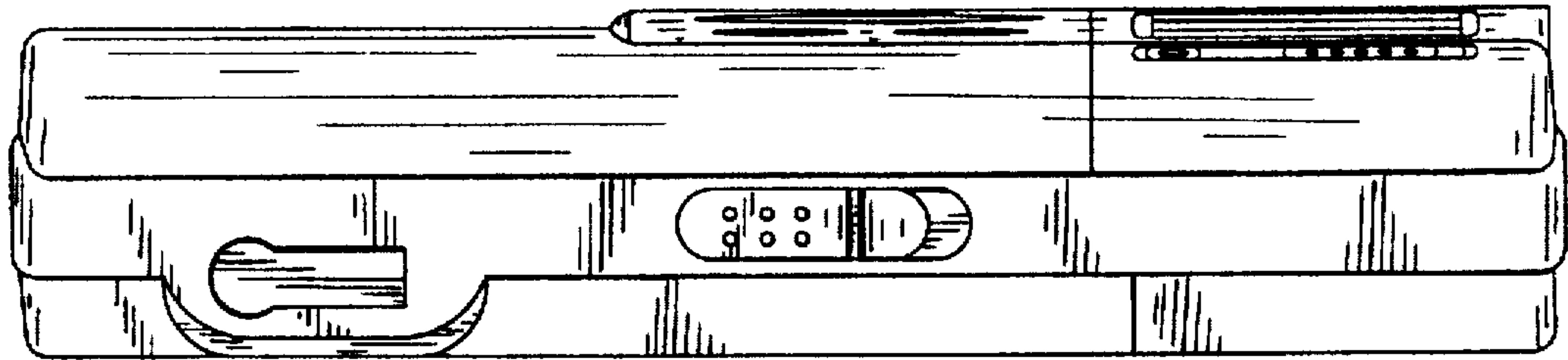

FIG. 9

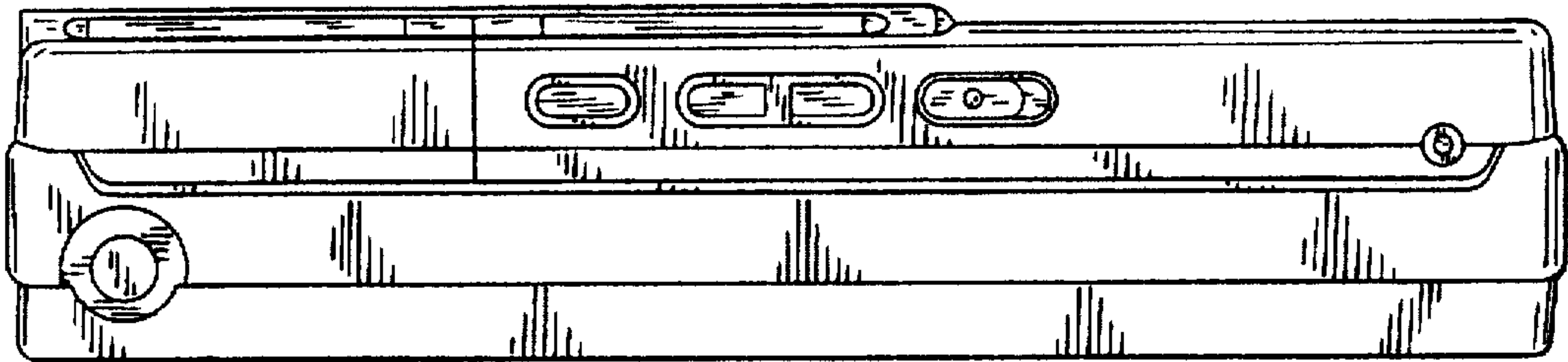

FIG. 10

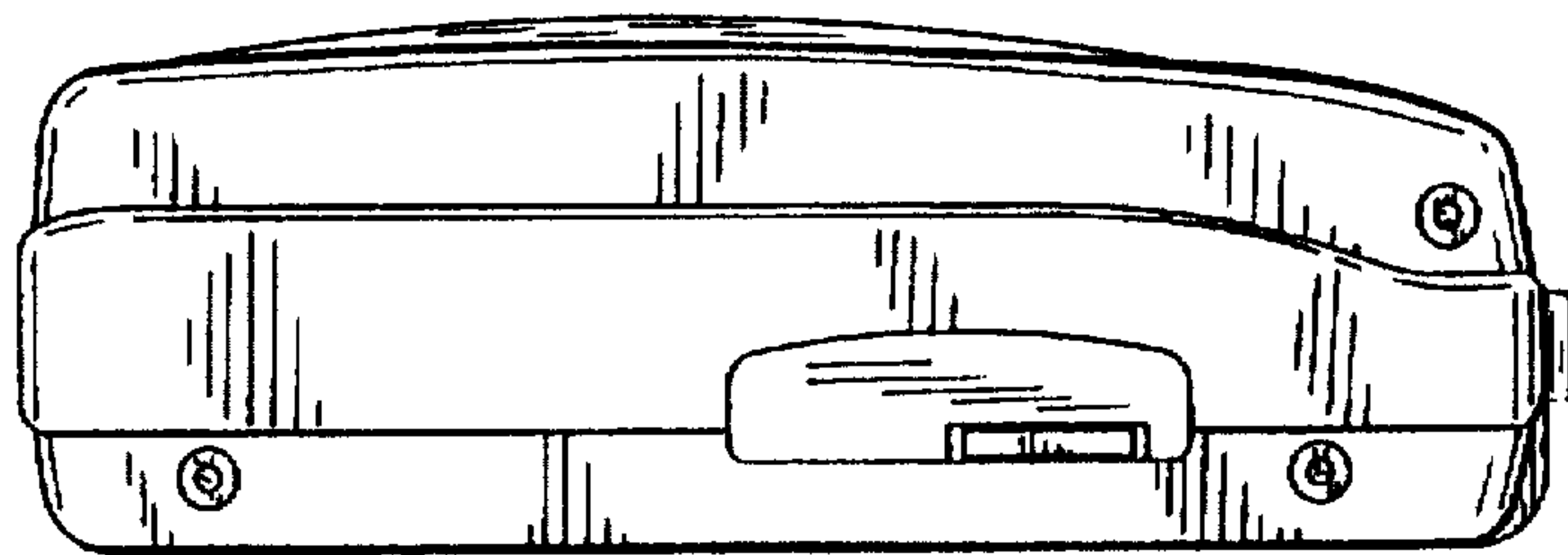

FIG. 13

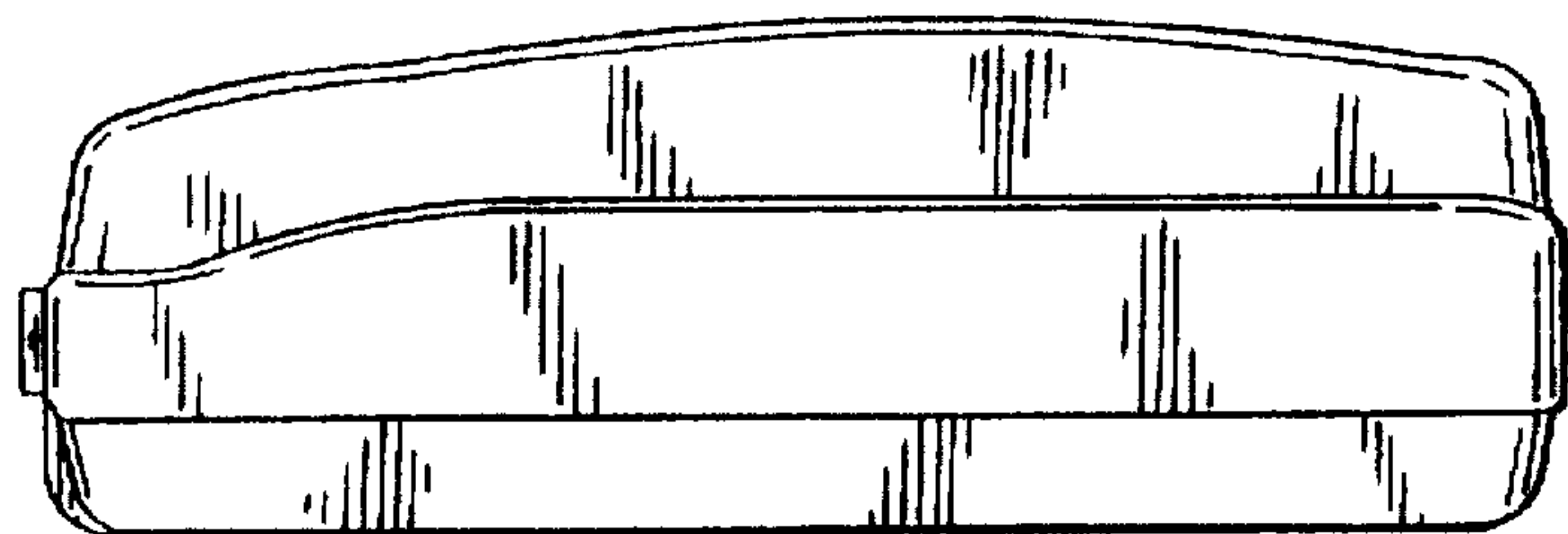

FIG. 11

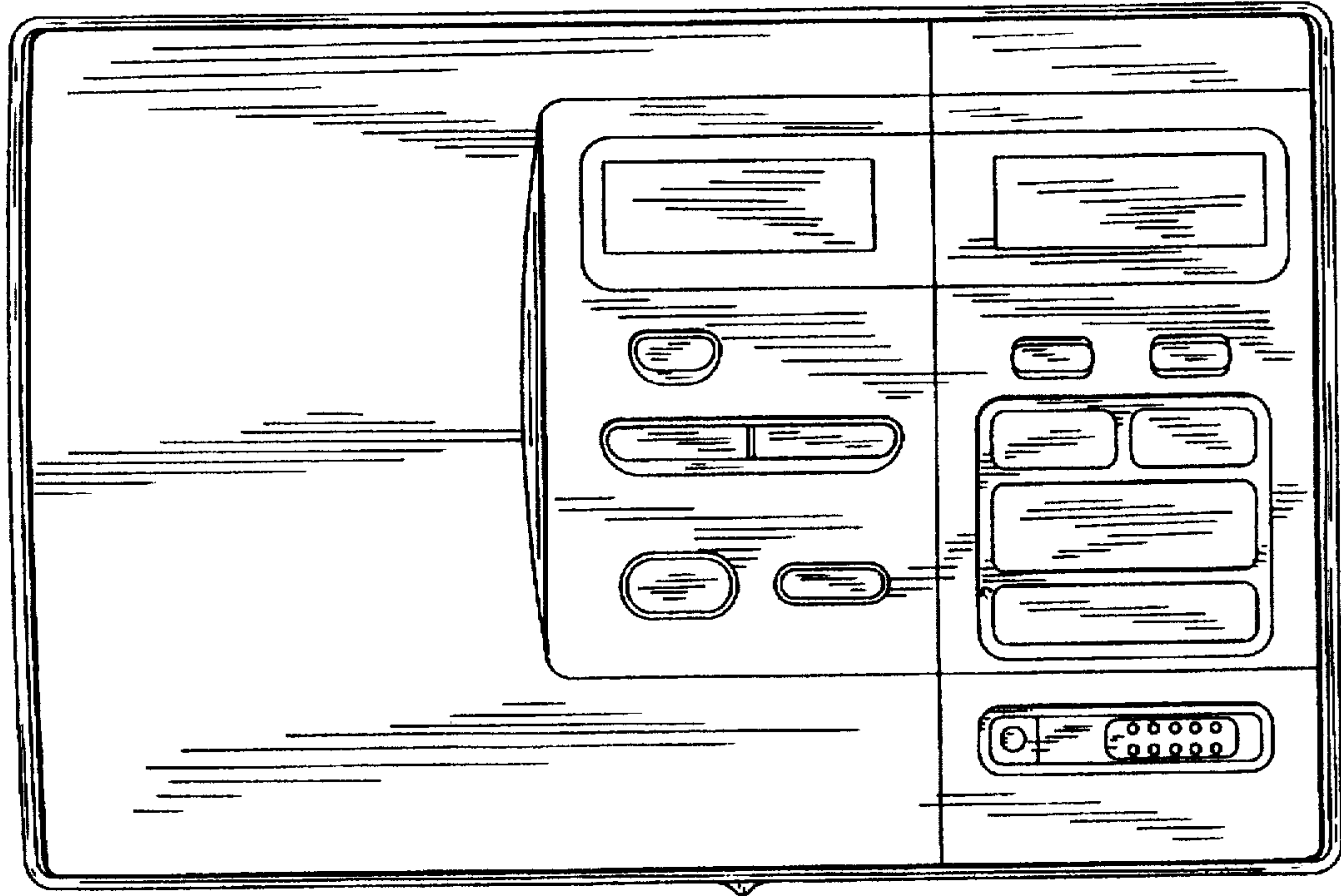

FIG. 14

